

NUTRIENT MANAGEMENT Planning Guide

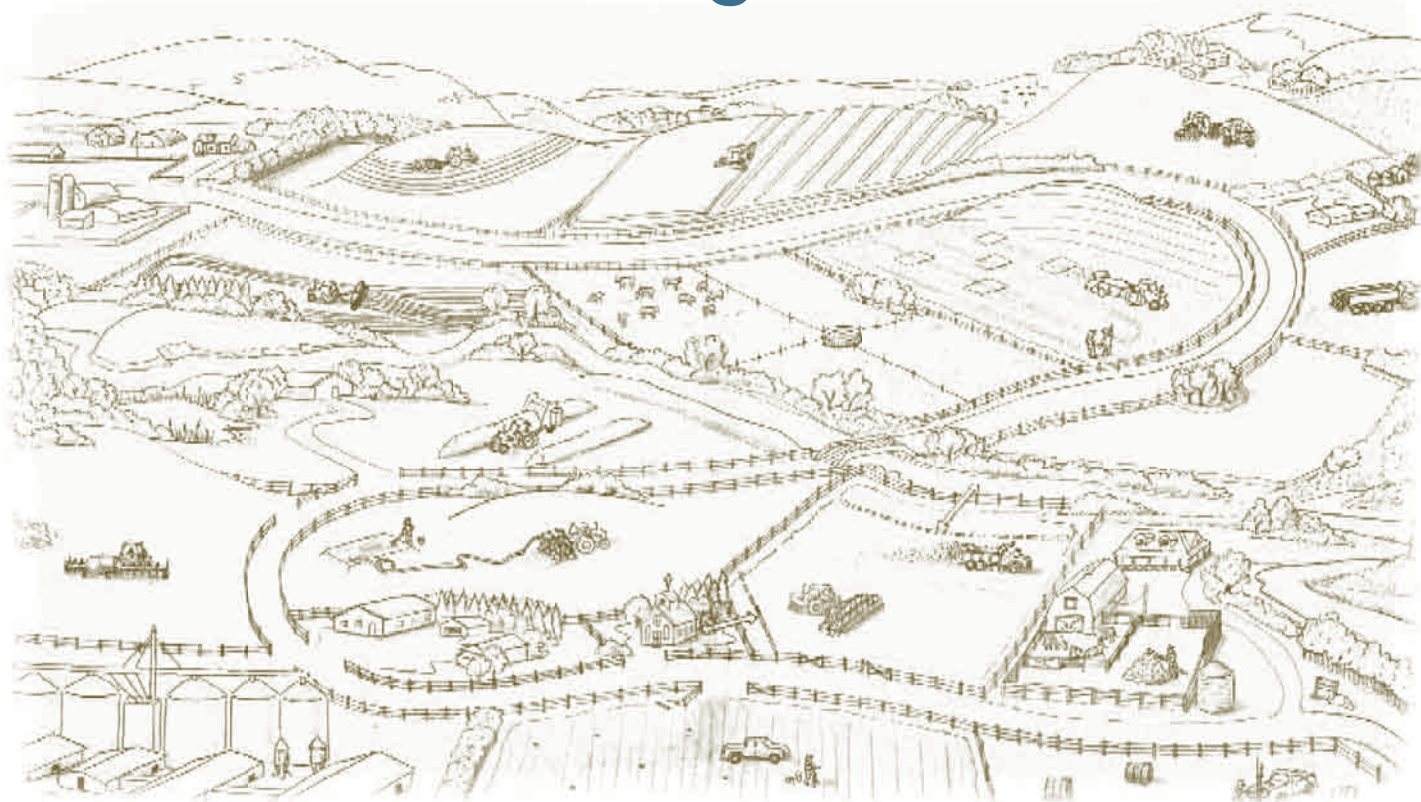

Forward

Nutrient Management Planning Guide for Alberta

This manual was prepared for Alberta crop and livestock producers and industry service providers to create a greater understanding of nutrient management planning processes, considerations, practices and action. It was designed to help managers of manure and fertilizer maximize their economic benefit and minimize their economic cost when managing nutrient applications.

It was developed through cooperation of government, industry and interested stakeholders. Information presented in this manual is based on the most current information sources and available research data as well as extensive field experience.

The manual contains calculations and data to assist producers in calculating crop nutrient needs and planning and managing nutrient applications through both manure and fertilizer sources. It also provides a range of management options to address nutrient application and associated losses so as to allow producers to choose options suitable for their situation.

Disclaimer

This manual was prepared for Alberta's agricultural industry to support nutrient management planning decisions and management. It was created using the best available information at the time of writing from published references as well as through consultation with industry, government and other stakeholders.

While the authors have made every effort to ensure the manual is accurate and complete, it should not be considered the final word on areas of law and practices it covers. Individuals should seek the advice of appropriate professionals and experts as the facts of each situation may differ from those set out in the manual.

All information (including descriptions of or reference to products, persons, websites, services or publications) is provided entirely "as is", and the authors make no representations, warranties or conditions, either expressed or implied, in connection with the use of or reliance upon this information. This information is provided to the recipient entirely at the risk of the recipient, and because the recipient assumes full responsibility, the author shall not be liable for any claims, damages or losses of any kind based on any theory of liability arising out of the use of or reliance upon this information (including omissions, inaccuracies, typographical errors and infringement of third party rights).

Acknowledgements

Developed by Alberta Agriculture and Food

» Steering Committee for the Nutrient Management Planning Guide for Alberta:

Matt Oryschak, Dale Chrapko, Nicole Huggins-Rawlins, Sandi Jones, Crystal Korth, Len Kryzanowski, Jennifer Neden, Doon Pauly, Krista Tremblett, and Trevor Wallace.

» Technical Input

Alberta Agriculture and Food:

Atta Atia, Phil Boehme, Dr. Jason Cathcart, Rob Dunn, Shawn Elgert, Lloyd Healy, Crystal Korth, Len Kryzanowski, Germar Lohstraeter, Dr. Ross McKenzie, Blaine Metzger, Jennifer Neden, Sheilah Nolan, Dr. Barry Olson, Matt Oryschak, Doon Pauly, Brian Sexton, Murray Tenove, Trevor Wallace, Michelle McKinnon, Deb Sutton, Julie Popowicz, Roger Bryan, John Zylstra, and Laura Ung.

Natural Resources Conservation Board:

Alasdair MacKinnon, Vince Murray, Karen Stewart, and Scott Cunningham.

Starland County: Lindsey Cherpin

Kneehill County: Callie Fox

AgroEnviro Consulting Services: John Harapiak

County of Two Hills: Kristian Stephens

Manitoba Agriculture and Food: Mitchell Timmerman

Alberta Environment: Krista Tremblett

Red Deer County: Donna Trottier

Agriculture and Agri-Food Canada: Dr. Frank Larney

The committee gratefully acknowledges the many Alberta Agriculture and Food (AF) staff, Agriculture and Agri-Food Canada (AAFC) staff, United States Department of Agriculture (USDA) staff and industry staff who contributed information for this manual.

» Photo and Illustration Credits

Individuals:

Scott Rawlings, Crystal Korth, Andy Jedrych, Len Kryzanowski, Matt Oryschak, Trevor Wallace, Dr. Jason Cathcart, and Don Wentz.

Corporate, government or non-government organizations:

Agriculture and Agri-Food Canada (AAFC)

Agriculture and Agri-Food Canada: Prairie Farm Rehabilitation Administration (AAFC-PFRA)

Agriculture and Food (AF)

AgTech Centre – AF

BC Ministry of Agriculture, Forestry and Lands

Canadian System of Soil Classification

Kuhn Industries

National Aeronautical and Space Administration (NASA)

National Resource Conservation Service

Ontario Ministry of Agriculture, Food and Rural Affairs

Soil Conservation Service, United States Department of Agriculture (USDA)

Reduced Tillage Linkages

Prairie Agricultural Machinery Institute

» Publication funded by

Alberta Environmentally Sustainable Agriculture Program

Alberta Agriculture and Food

» Graphic Design and Layout:

Alberta Agriculture and Food:

Nicole Huggins-Rawlins

Crystal Korth

» Illustrations and Cover Design:

Crystal Korth

Table of Contents

About this Manual	6
Features of this Manual	6
Commonly Used Acronyms in this Document	7
Module 1 Introduction	
Chapter 1.1 About this Guide	9
Chapter 1.2 Nutrient Management Planning in Alberta	15
Module 2 Nutrient Cycling and Interactions	
Chapter 2.1 Soil Nutrient Cycling	19
Chapter 2.2 Basic Soil-Plant Interactions	37
Chapter 2.3 Manure and Fertilizer as Sources of Nutrients and Potential Environmental Hazards	51
Module 3 Field and Soil Evaluation	
Chapter 3.1 Field Assessment	57
Chapter 3.2 Using Aerial Photos for Nutrient Management Planning	77
Chapter 3.3 Soil Sampling	87
Chapter 3.4 Practical Use of Soil Analysis Results	99
Module 4 Manure Inventory and Application	
Chapter 4.1 Estimating Manure Inventory	119
Chapter 4.2 Manure Sampling	141
Chapter 4.3 Manure Test Interpretation	157
Chapter 4.4 Manure Application and Alberta's <i>Agricultural Operation Practices Act (AOPA)</i>	169
Chapter 4.5 Manure Application Equipment	177
Chapter 4.6 Calibrating Manure Application Equipment	187

Module 5 Fertilizer Application

Chapter 5.1	Getting the Most out of Commercial Fertilizer Applications	201
-------------	--	-----

Module 6 Determining Nutrient Requirements

Chapter 6.1	Calculating Manure Application Rates and Fertilizer Requirements	211
-------------	--	-----

Module 7 Record Keeping

Chapter 7.1	Record Keeping Requirements and the Agricultural Operation Practices Act (AOPA)	227
-------------	---	-----

Chapter 7.2	AFFIRM and Alberta MMP Software	237
-------------	---	-----

Module 8 Land and Production Management

Chapter 8.1	Factors Affecting Runoff Nutrient Losses	259
-------------	--	-----

Chapter 8.2	Cropping Practices to Reduce Nutrient Losses in Runoff	267
-------------	--	-----

Chapter 8.3	Constructed Erosion Control Measures to Reduce Nutrient Losses in Runoff	279
-------------	--	-----

Appendices

Appendix 3A	Acreage Grid Map for Aerial Photo Interpretation.	290
-------------	---	-----

Appendix 3B	Products Available from the Air Photo Distribution Office	292
-------------	---	-----

Appendix 3C	List of Laboratories Offering Soil and Manure Analysis Services	293
-------------	---	-----

Appendix 3D	How to Use a Slope Gauge	295
-------------	------------------------------------	-----

Appendix 4A	Standard Values for Manure Nutrient Content and Estimated Daily Manure Production.	296
-------------	--	-----

Appendix 6A	Crop Nutrient Uptake and Removal Coefficients	300
-------------	---	-----

Appendix 6B	Calculating Expected Nutrient Uptake and Removal	302
-------------	--	-----

References	303
-------------------	-----------	------------

About this Manual

The Nutrient Management Planning Guide for Alberta is a resource for developing field-scale nutrient management plans. The primary objective of this guide is to facilitate nutrient management planning in Alberta. Information within the guide draws from theory, critical procedures and Alberta-specific considerations. The guide is laid out in eight modules, which are further divided into chapters that address specific topics.

Features of this Manual

Learning objectives

At the beginning of each chapter specific learning objectives are identified. These objectives outline what an individual will be able to accomplish upon working through the chapter.

Important terms

Most chapters begin with a list of important terms and definitions. These are words or terms that appear in the chapter for which a definition was thought to be beneficial. Terms are defined at the beginning of the chapter in which the word was first used.



more info

These boxes direct the reader to additional publications or sources of information that provide a more detailed discussion of topics covered more generally in this manual. These are presented as sidebars with related information in the text.



tip

Important processes, directions or considerations are highlighted in 'Tip' boxes.

sidebar

Sidebars highlight facts and key information or concepts related to information in the text.



summary

Each chapter concludes with a summary in point form, which relates back to the learning objectives at the beginning of that chapter.

Commonly Used Acronyms in this Document

AAFC	Agriculture and Agri-food Canada	NMP	Nutrient Management Plan
AF	Alberta Agriculture and Food	NRCB	Natural Resources Conservation Board
AFFRM	Alberta Farm Fertilizer Information and Recommendation Manager	NSERL.	National Soil Erosion Laboratory
AGRASID	Agricultural Region of Alberta Soil Inventory Database	MMP.	Manure Management Planner
AOPA	<i>Agricultural Operation Practices Act</i>	PAMI.	Prairie Agricultural Machinery Institute
APEGGA	Association of Professional Engineers, Geologists and Geophysicists of Alberta	PFRA	Prairie Farm Rehabilitation Administration
ASIV.	Alberta Soil Information Viewer	RUSLE.	Revised Universal Soil Loss Equation
CCA	Certified Crop Advisors	SAR	Sodium Adsorption Ratio
CCE	Calcium Carbonate Equivalent	SBU	Seed Bed Utilization
CEC	Cation Exchange Capacity	SI.	Salt Index
CFO	Confined Feeding Operation	USDA-ARS	Agricultural Research Service of the US Department of Agriculture
EC	Electrical Conductivity	USLE.	Universal Soil Loss Equation
ENR	Estimated Nitrogen Release	VFB	Vegetative Field Borders
GPS	Global Positioning System	VFS	Vegetative Filter Strips
IR	Investment Ratio	WEPP	Water Erosion Prediction Project

Chapter 1.1

About this Guide

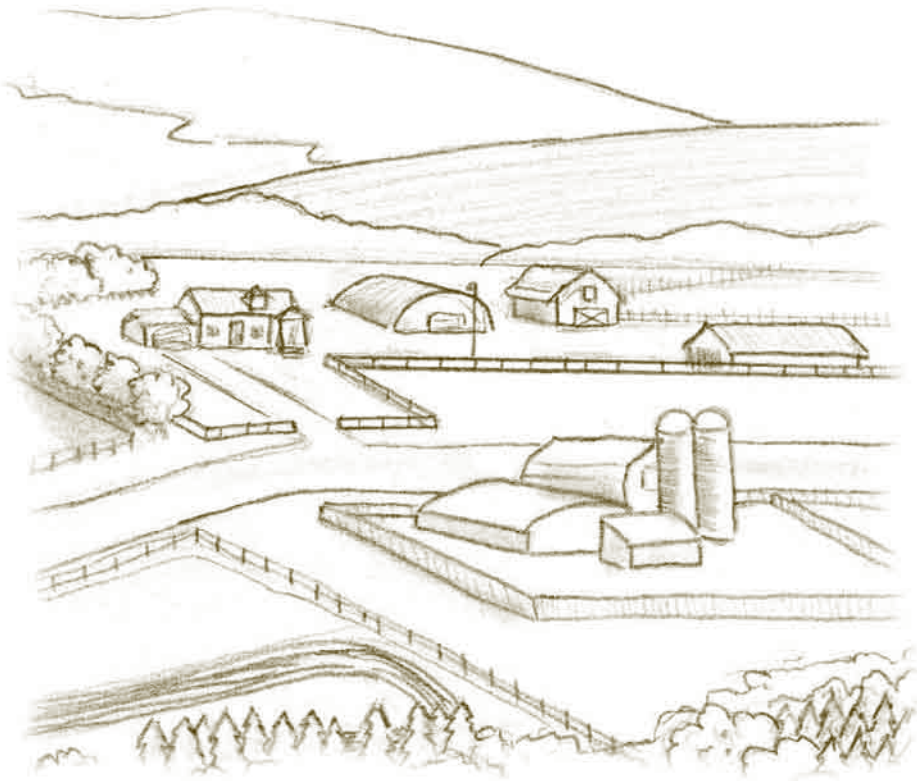

➔ learning objectives

- Describe the objectives of the Nutrient Management Planning (NMP) Guide.
- Identify key resources available in Alberta to complete a NMP.

tip



See the Association of Alberta Agricultural Fieldmen website, www.aaaf.ab.ca, for a list of Agricultural Fieldmen.



Drawing from theory, critical procedures and Alberta-specific considerations, the Nutrient Management Planning Guide is a resource for developing field-scale nutrient management plans. These plans will ensure the responsible use of plant nutrients, from livestock manure or commercial fertilizers, to protect surface water resources.

Objectives of this Guide

The primary objective of this guide is to facilitate nutrient management planning in Alberta. It will:

1. Provide a basic understanding of interactions among soil, nutrients, plants and the environment,
2. Identify and describe key nutrient management planning procedures,
3. Describe management practices and site-specific controls to reduce the risk of nutrient loss to air and water, and
4. Communicate legislated standards on nutrient management in Alberta.

Target Audience for this Guide

This guide is intended as a train-the-trainer resource for extension personnel and service providers. However, it is also a useful resource for crop and livestock producers and students.

How this Guide is Structured

The guide is organized into eight modules. Each module consists of specific activities and topics.

Module 1 Introduction

Module 2 Nutrient Cycling and Interactions

Module 3 Field and Soil Evaluation

Module 4 Manure Inventory and Application

Module 5 Fertilizer Application

Module 6 Determining Nutrient Requirements

Module 7 Record Keeping

Module 8 Land and Production Management

Is There a Recommended Format for a NMP in Alberta?

For NMPs in Alberta, content is more important than form. NMPs must meet specific information requirements (see Chapter 1.2); however, there are no standard formatting requirements.

Resources

Service providers and producers can use several sources of information to complete a NMP, including:

- Government and non-government resource personnel,
- Print and online publications,
- Internet-available tools and calculators.

People

» Extension Specialists and Agricultural Fieldmen

Extension Specialists and Agricultural Fieldmen work for local municipalities throughout the province. Contacting your municipality is a good first step in obtaining information related to nutrient management planning.

» Ag-Info Centre

The Ag-Info Centre (Alberta Agriculture and Food) is an excellent resource for production-related inquiries. The Centre has specialists with extensive expertise in crop and soil fertility issues.

Hours of Operation:

8:00 am to 5:00 pm, Monday to Friday,
except statutory holidays

How to Contact the Centre:

Toll-free (in Alberta): 310-FARM (3276) or
1-866-882-7677

Out of province: (403) 742-7901

» **Certified Crop Advisors**

Certified Crop Advisors (CCA) work for agricultural retailers, fertilizer dealers or as private consultants. They can be valuable sources of information for a wide range of issues relating to crop production, including nutrient management. CCA are accredited through the American Society of Agronomy.

Publications

Alberta Agriculture and Food (AF) Publications Office in Edmonton has many free and priced publications related to crop production, soil fertility and environmental management for agriculture.

To order an index catalogue or hard copies of selected publications, call 1-800-292-5697 (toll-free in Canada) or (780) 427-0391.

Most free publications can be viewed and downloaded (.html or .pdf format) from AF's website, Ropin' the Web, at www.ropintheweb.com.

Internet-Available Tools

In addition to online publications, Ropin' the Web has several tools to assist in developing a NMP. Some of these are described briefly below and are also mentioned later in this guide.

» **Alberta Soil Information Viewer**

This free online viewer allows the user to view and search soils information in the Agricultural Region of Alberta Soil Inventory Database (AGRASID) Version 3.0. Many have found this tool useful when making land management decisions.

To access the viewer homepage on Ropin' the Web, enter "soil information viewer" in the search window.

» **Alberta Farm Fertilizer Information and Recommendation Manager (AFFIRM)**

AFFIRM is a software package that generates customized fertilizer recommendations based on cropping practices, soil and environmental conditions and crop production economics. AFFIRM was developed from Alberta research and can recommend fertilizer rates for over 40 different Alberta crops.

To access the AFFIRM homepage on Ropin' the Web, enter "AFFIRM" in the search window.

» **Alberta Manure Management Planner**

The Alberta Manure Management Planner (MMP) software package is an adaptation of a manure management tool developed by Purdue University (West Lafayette, Indiana, United States) that incorporates Alberta data. Information about an operation's fields, crops, nutrient requirements, manure storage, animals and manure application equipment is used to plan nutrient applications.

To access the MMP homepage on Ropin' the Web, enter "MMP" in the search window.

Online Calculators

Ropin' the Web also houses several online calculators that relate to crop production, including:

tip

To find a CCA near you, visit the Prairie CCA Board online at www.prairiecca.ca.



tip



Ropin' the Web is updated frequently with new resources.

Check the website regularly to see what's new.



» [Seeding Rate Calculator](#)

Calculates seeding rates for a wide range of crops based on: desired plant density, germination rate, emergence mortality, row spacing, 1000-kernel weight and the number of acres to be seeded.

» [Forage Seed Mixture Calculator](#)

Calculates a seed mix and estimates a seed density for drills or broadcast seedings for any grouping of plant species in the list.

» [Grains, Forage and Straw Nutrient Use Calculator](#)

This calculator allows producers to estimate the crop uptake and removal of nitrogen (N), phosphorus (P), potassium (K), sulphur (S) and calcium (Ca).

To access the homepage for online calculators on Ropin' the Web, enter "crop calculators" in the search window or click on the "Calculators" tab on the toolbar above the main viewing window.

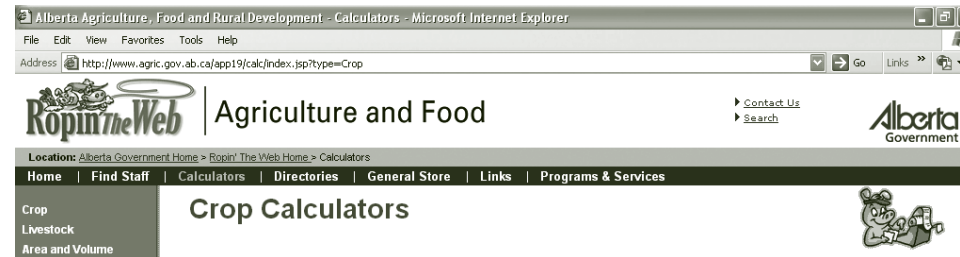

summary

- The main objective of this guide is to provide an understanding of the principles and practices of nutrient management, with the goal of facilitating nutrient management planning.
- There are many resources available to support the development of a NMP, including public and private sector experts, extension publications and web-available tools and calculators.

Chapter 1.2

Nutrient Management Planning in Alberta

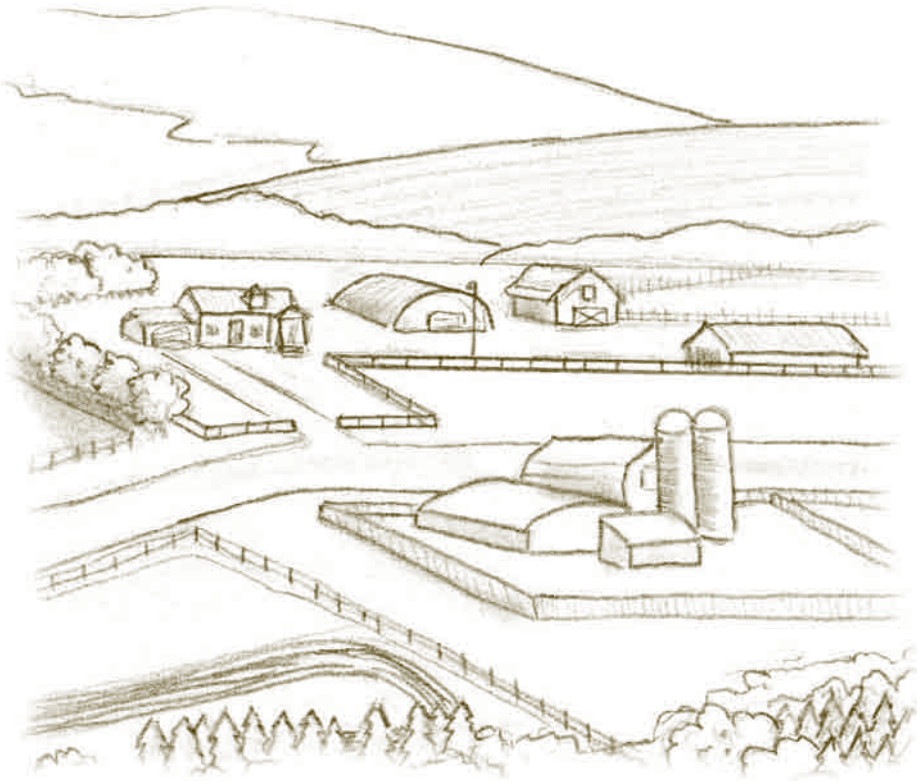

➔ learning objectives

- List the five components of a NMP in Alberta.
- Briefly describe the role that the *Agricultural Operation Practices Act (AOPA)* has on nutrient management planning in Alberta.

sidebar

NMPs in most jurisdictions share several common features including: an estimate of nutrient requirements for a crop and field; an evaluation of the nutrient content of available nutrient sources; and an application strategy to meet nutrient requirements in an efficient and environmentally responsible way.

more info



For more information about AOPA, please contact the NRCB office nearest you, or visit them at www.nrcb.gov.ab.ca.

Many producers are considering livestock manure as an alternative nutrient source to offset fertilizer requirements. NMPs integrate and balance sources of nutrients (i.e., fertilizer, manure and soil) with crop requirements. A NMP is key to ensuring that nutrients for crop production are utilized in an economically and environmentally responsible way.

NMPs in Alberta

A NMP in Alberta consists of the following components:

- 1. Field (or site) assessment** – includes soil test information, area, soil texture, estimated length and grade of any slopes, problem soil conditions (e.g., solonchic soils) and limiting physical features such as environmentally sensitive areas (e.g., water bodies).
- 2. Manure inventory** – includes estimated nutrient content (from lab analysis or standard values), estimated manure volume(s) and desired information about the animal population or the operation (e.g., number of animals, phase of production, housing and feeding system, etc.).
- 3. Nutrient application plan** – includes information about manure application and incorporation methods, equipment calibration, planned crop rotation, cropping system, planned application rate (manure and fertilizer), timing of application and incorporation, and the nutrient on which application is based (i.e., N or P).
- 4. Land management plan** – includes information on production practices and other control systems to reduce post-application nutrient losses.
- 5. Record keeping system** – includes a system of record keeping that complies with the Agricultural Operation Practices Act (AOPA) record-keeping requirement for manure application.

AOPA

AOPA establishes standards for siting, development and certain management practices for livestock operations in Alberta. While AF is responsible for the Act, the Natural Resources Conservation Board (NRCB) administers the regulations under the Act.

The Standards and Administration Regulation under AOPA establishes standards for manure management in Alberta in five key areas:

- Manure storage facility design
- Manure application limits
- Manure application setback distances from water bodies
- Record keeping
- Soil testing

While manure storage facility design is not a component of this guide, compliance issues relating to the remaining four areas above are discussed in relevant chapters.

summary

- The components of a NMP in Alberta are: a **field assessment, manure inventory, nutrient application plan, land management plan** and record-keeping system.
- The Standards and Administration Regulation of AOPA establishes standards for storage facility design, application limits, application setback distances from water bodies, record keeping and soil testing.

Chapter 2.1

Soil Nutrient Cycling

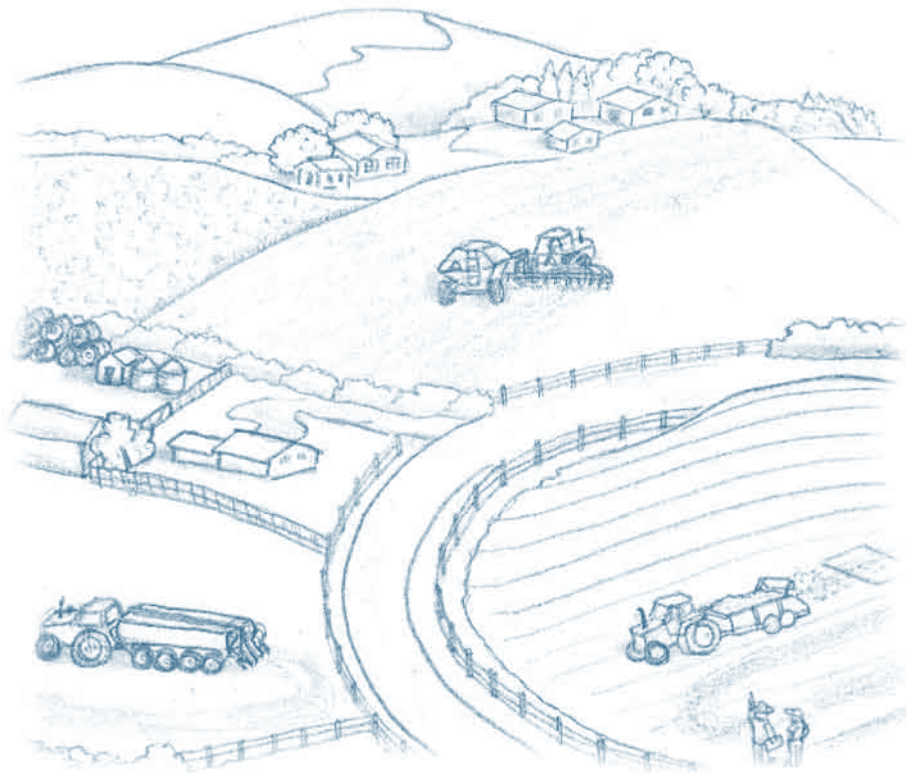

→ learning objectives

- List and classify sixteen essential plant nutrients.
- Explain the “law of minimum” as it pertains to crop nutrition.
- **Briefly describe three ways plants absorb ions from the soil.**
- Compare and contrast nutrient availability from different soil nutrient pools.
- Summarize the processes that occur as part of nutrient cycling in soils.

Important Terms

Table 2.1.1 Key Terms and Definitions

Term	Definition
Adsorption	Is the physical adherence or bonding of ions and molecules onto the surface of another molecule.
Denitrification	The process where soil micro-organisms obtain their oxygen from nitrates and nitrites, resulting in the release of nitrogen or nitrous oxide. This can happen in waterlogged soils when oxygen is limited and anaerobic decomposition occurs.
Eutrophication	The natural 'aging' of aquatic systems caused by the introduction of limiting nutrients.
Fixation (nitrogen)	The conversion of atmospheric nitrogen by soil micro-organisms, such as rhizobia, into organic forms, which can be released into a form plants can use.
Humus	Any organic matter that has reached a point of stability and breaks down very slowly.
Immobilization	The absorption by micro-organisms of nutrients released from organic matter decomposition, preventing these nutrients from being available to plants. The opposite to mineralization.
Labile	Nutrients or organic material that is constantly changing or susceptible to rapid changes.
Leaching	The downward movement of substances, such as nutrients, in water through soil pores.
Macronutrient	An essential chemical element, such as nitrogen or phosphorus that is needed by plants in large quantities for it to function normally.
Micronutrient	An essential chemical element, such as boron or zinc that is needed by plants in small quantities for it to function normally.
Mineralization	In biology, this is the process where an organic substance is converted to an inorganic substance.
Nitrification	The biological addition of oxygen to (oxidation of) ammonia creating nitrite that can be further oxidized into nitrate.
Precipitation	In chemistry, this is the condensation to a solid from a solution during a chemical reaction.
Salinity	The accumulation of free salts in the soil solution.
Sorption	The action of either absorption or adsorption. It is the effect of gasses or liquids being incorporated into material of a different state and adhering to the surface of another molecule.
Stomata	Is a pore or opening in plant leaves (plural term for stoma). Guard cells close and open the stoma, controlling the loss of water vapour and other gasses from the plant.
Transpiration	The process of evaporation of water from above ground parts of plants.
Volatilization	Gaseous loss to the atmosphere. In a nutrient management context, it is the loss of ammonia gas to the atmosphere.

Sixteen mineral and non-mineral nutrients are essential for plant growth. The non-mineral nutrients—carbon (C), hydrogen (H) and oxygen (O)—account for approximately 96% of dry plant weight, mostly in the form of carbohydrates. The sources of C, H, and O in plant materials are carbon dioxide (CO_2) in air and water (H_2O). The energy that drives their conversion into plant material is derived from sunlight.

Mineral nutrients, classified as macro- or micronutrients, are usually obtained from the soil. The macronutrients—nitrogen (N), phosphorus (P), potassium (K), sulphur (S), calcium (Ca) and magnesium (Mg)—account for approximately 3.5% of dry plant weight. Accounting for about 0.04% of dry plant weight are the micronutrients—chlorine (Cl), iron (Fe), manganese (Mn), zinc (Zn), boron (B), copper (Cu) and molybdenum (Mo). While this is widely regarded as the traditional list of essential micronutrients, some experts argue that elements such as nickel (Ni), silicon (Si) and cobalt (Co) should be included.

For the majority of prairie soils, N is typically the most deficient (e.g., first limiting) nutrient, followed by P, K, and S. Micronutrient deficiencies in western Canadian soils are rare compared to the size, extent and financial importance of N, P, K, and S deficiencies.

The Principle of the First-Limiting Nutrient

Plant growth will take place normally until it is restricted by the supply of an essential nutrient. A deficiency of any essential nutrient cannot be corrected by the addition of other crop inputs. This forms the basis of Liebig's "Law of the Minimum", which says that the level of crop production is limited by the nutrient in shortest supply.

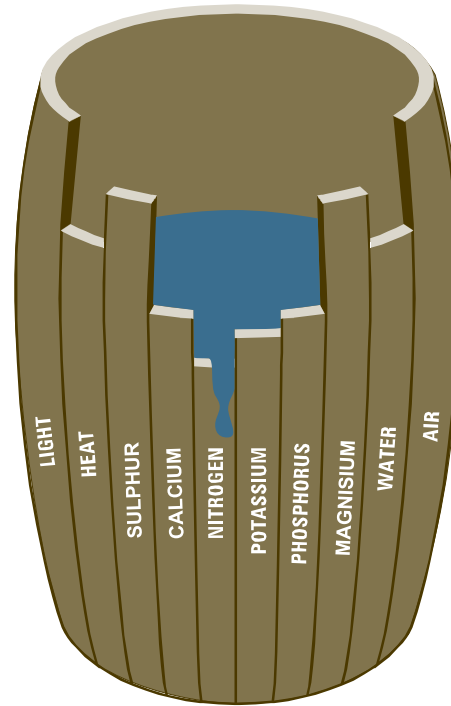

Adapted from Brady and Weil, 2002

Figure 2.1.1 Conceptual Illustration of the Law of the Minimum, Showing Nitrogen as the Most Limiting Nutrient for Crop Growth

Crop yield is determined by the supply of individual nutrients relative to their required levels for optimal yield. In Figure 2.1.1, the capacity of the barrel represents crop yield, which is limited by the height of the shortest stave of the barrel (e.g., the first limiting nutrient, which is N in this example).

Ion Absorption by Plant Roots

Generally, plants absorb essential nutrients from the soil in soluble, inorganic forms. Nutrients in organic form must be converted to inorganic forms prior to plant

uptake. Exceptions to this generality include some metal elements that can be absorbed as organic complexes.

In order for ions to be absorbed by plant roots, they must come into contact with the root surface. This happens through three main mechanisms: root interception, mass flow, and diffusion.

Root Interception

Root interception is the uptake of nutrients by plant roots as they grow through the soil and incidentally come into contact with nutrients. Nutrient uptake by root interception is directly related to the volume of the root system, which in most cases is less than 1% of the total soil volume. Consequently, root interception makes a small contribution to total nutrient uptake.

Mycorrhiza and Plants— An Infectious Partnership

Plant-mycorrhizal associations increase functional root volume. Mycorrhizal fungi infect plant roots and produce their own root-like structures called hyphae, which act as extensions of the plant's root system. Nutrient absorption is enhanced since the hyphae can increase the absorptive surface area of root systems by up to ten times compared to non-infected root systems.

Mass Flow

In mass flow, dissolved nutrients move with water towards root surfaces where they are absorbed. Mass flow is a significant mechanism for the uptake of some nutrients, such as nitrogen. Nutrient uptake by mass flow is reduced in dry conditions and at lower temperatures because the rate of transpirational water uptake is reduced (Figure 2.1.2).

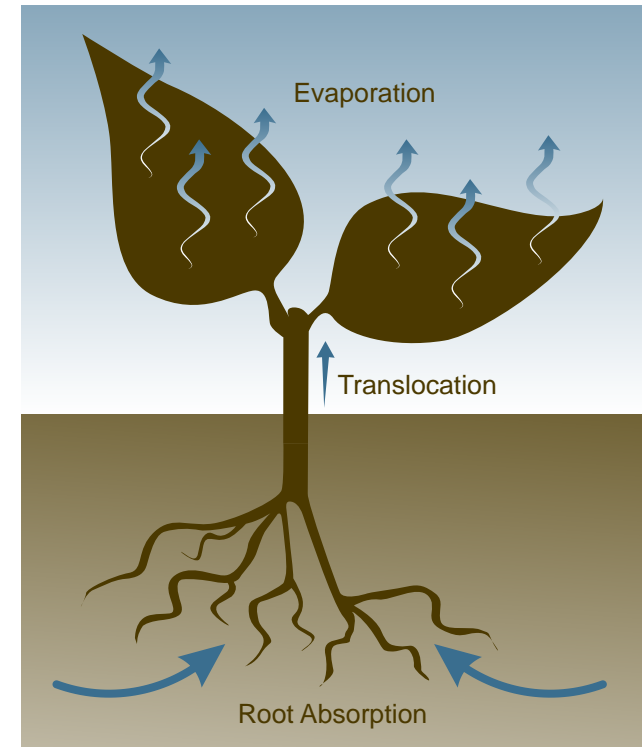

Created by Len Kryzanowski

Figure 2.1.2 Transpirational Movement of Water Through a Plant

While mass flow helps the plant meet its requirements for essential nutrients, it frequently results in excess uptake of several soluble nutrients including K^+ , Ca^{2+} , and Mg^{2+} . This luxury uptake is not essential for crop growth, but can contribute to better feed or food quality of the harvested crop.

Diffusion

Diffusion is the process by which nutrients spread from areas of high concentration to areas of low concentration. When roots absorb nutrients from soil solution the concentration of nutrients surrounding the root drops. As a result, nutrients in areas of higher concentration in soil solution migrate toward the root. Diffusion is an important process in crop uptake of P and K.

Table 2.1.2 Relative Contributions of Root Interception, Mass Flow, and Diffusion in Nutrient Transport to Corn Roots

Relative percentage of nutrients absorbed from the soil by a 12 t/ha (200 bu/ac) corn crop through root interception, mass flow, and diffusion			
Nutrient	Root Interception	Mass Flow	Diffusion
N	1	99	0
P	2	4	94
K	2	20	78
Ca	120	440	0
Mg	27	280	0
S	4	94	2

Adapted from Havlin et al. 2005

Nitrogen

Nitrogen is a key component of soil organic matter and is required by plants in large quantities. It is often the first limiting nutrient in prairie cropping systems.

Nitrogen forms a part of every living cell. It is an essential component of amino acids — the building blocks for proteins. The amount of N supplied to plants influences the production of plant proteins such as enzymes, mitochondria and carrier, storage and structural proteins.

Chlorophyll is the N-based plant component responsible for photosynthesis. The amount of chlorophyll in a plant is reflected by the shade of green in plant leaves. Therefore, plant leaves can provide a visual clue to the N status of a crop (e.g., lighter shades of green in plant leaves could suggest an inadequate N supply).

N Cycling in Soils

Nitrogen forms present in soil are constantly undergoing change. Nitrogen cycling is a relationship involving gains, losses and transformations of N among pools in the soil (Figure 2.1.3).



sidebar

Commercial N fertilizers are produced through industrial N fixation. Atmospheric N_2 is reacted with hydrogen gas (produced from the steam treatment of natural gas) under high pressure and heated to form NH_3 , which can be used directly as a fertilizer (i.e., anhydrous ammonia) or can undergo additional processing to produce other forms of N fertilizer.

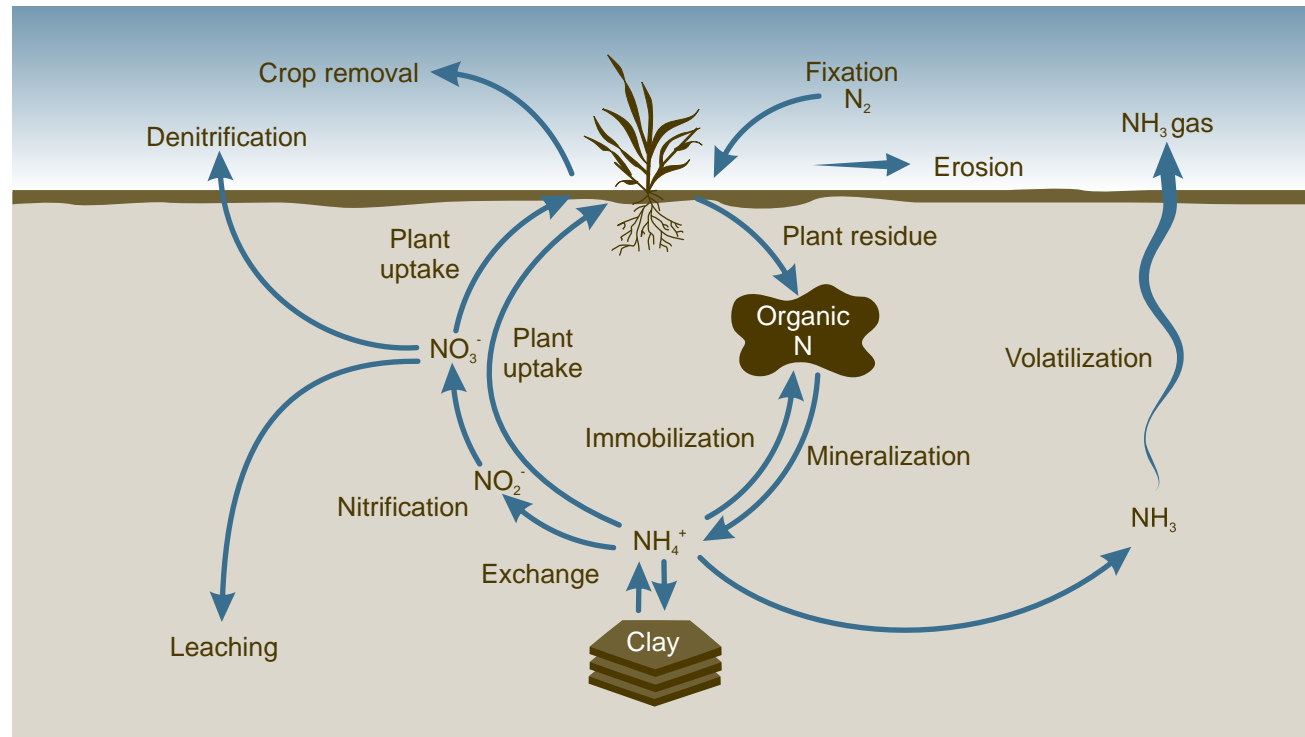

Adapted from Jones and Jacobsen 2001a

Figure 2.1.3 The Agricultural Nitrogen Cycle

Seven forms of N are involved in the N cycle: atmospheric N gas (N_2), ammonium (NH_4^+), ammonia (NH_3), nitrate (NO_3^-), nitrite (NO_2^-), nitrogen oxide gases (NO , N_2O) and organic N. Each form of N exists in a pool. For example, organic N is part of the organic pool, NO_3^- exists in the soil solution pool and NH_4^+ can be present in the soil solution or exchangeable pool. Plants can only directly use inorganic N (NH_4^+ and NO_3^-) to meet their N requirements.

Atmospheric N_2 makes up 78% of the gases in the atmosphere. While N frequently limits crop production, thousands of tonnes are present in the air. For crops to access this pool of N it must be converted to a plant-available form. Legumes (e.g., alfalfa, clover, peas, beans) are able to access atmospheric N_2 through a symbiotic relationship with Rhizobium bacteria (Figure 2.1.4). In exchange for energy, Rhizobium convert atmospheric N_2 to plant-available forms in a process called fixation.

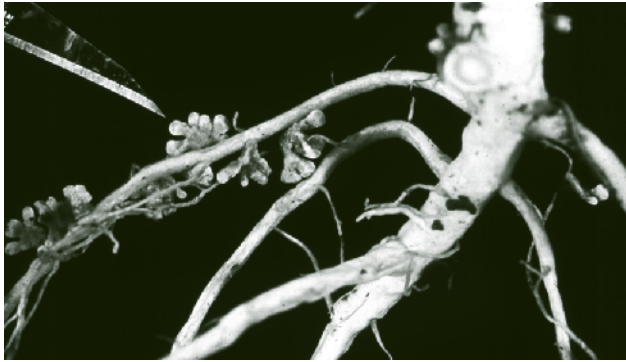

Photo courtesy Surya Acharya, AAFC

Figure 2.1.4 Root Nodules on a Legume Inhabited by Rhizobium Bacteria

Organic N compounds are an important source of N for crops. These compounds, which are part of soil organic matter, must undergo decomposition before the N they contain is plant available. Soil organisms (e.g., insects, small animals, and microorganisms) gradually break down complex N compounds into simpler forms in a process called mineralization. In the process of N mineralization, organic N compounds are converted to NH_4^+ , which can be taken up by plants from the soil. However, NH_4^+ is usually converted quickly to NO_3^- by bacteria in the soil through a process called nitrification.

Ammonium has a positive charge and can be temporarily held by negative charges on soil particles. This type of reaction is called cation exchange and will be discussed further in Chapter 2.2. It is important to know that exchange reactions are critical to the nutrient holding capacity of the soil and the ability of the soil to replenish nutrient concentrations in the soil solution. Adsorbed NH_4^+ makes up a portion of the exchangeable pool of N, but as adsorbed NH_4^+ it is unavailable for plant uptake until released into soil solution.

Nitrogen in the soil can also be temporarily tied up by the microbial biomass, in a process referred to as immobilization. Soil microbes require N to decompose crop residues and can get this either from the residue or soil solution. Residues with higher carbon to nitrogen ratios and more lignin, like cereal straw, decompose more slowly, immobilizing N for longer periods. Eventually decomposition will slow and microbial biomass will release the N, increasing plant available N.

Nitrogen can be lost from the soil in four alternative ways depending on the chemical form. NH_4^+ can be converted to NH_3 gas and lost to the atmosphere through volatilization. Situations that favour NH_3 volatilization include alkaline soil pH, low buffering capacity (directly related to cation exchange capacity) and warm moist (but drying) soil conditions. NO_3^- can be lost from soil through denitrification – the conversion to N_2O or N_2 gas through microbial activity when soil oxygen levels are low. Soils that experience anaerobic (low oxygen) conditions (e.g., water logging) are more subject to denitrification.

Nitrogen is also lost from soil systems through leaching and runoff. Nitrate is one of the most mobile nutrients in the soil system and readily moves with soil water. Leaching losses of NO_3^- in Alberta are limited because of the semi-arid prairie climate, although exceptions do exist. Leaching can occur in years of abnormally high rainfall, under irrigation and on fallowed fields, especially when these conditions occur on coarse-textured soils.

Another mode of N loss from soil is through surface runoff carrying dissolved nutrients or sediments. This can then enter surface water ecosystems, contributing to eutrophication.





Phosphorus

Less than 20% of the total P content of surface soils (0 to 15 cm) is plant-available. Consequently, P is regarded as the second most limiting nutrient in western Canadian soils.

One of the main roles of P in plants is the storage and transfer of energy. The high-energy phosphate bonds in molecules such as adenosine triphosphate (ATP) and adenosine diphosphate (ADP) drive virtually every biochemical reaction in plants (Figure 2.1.5). Phosphorus is also part of important structural components of plants, such as nucleic acids, phospholipids and coenzymes.

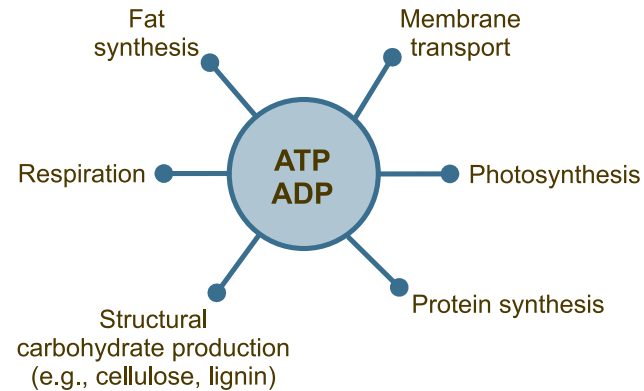

Figure 2.1.5 Summary of Processes and Functions Driven by High-Energy Phosphate Bonds in ATP and ADP

Why Fertilizer P and K Content is Expressed as Percent P_2O_5 and K_2O

Years ago, geochemists described mineral contents as the oxide forms of elements that form upon heating of a substance. When laws governing fertilizer usage were being developed, this standard was adopted (although these are not the actual forms that are in commercial fertilizers).

To convert between P_2O_5 and K_2O and their elemental P and K forms, the conversion factors below can be used:

$$\% P_2O_5 \times 0.44 = \% P$$

$$\% P \times 2.29 = \% P_2O_5$$

$$\% K_2O \times 0.83 = \% K$$

$$\% K \times 1.2 = \% K_2O$$

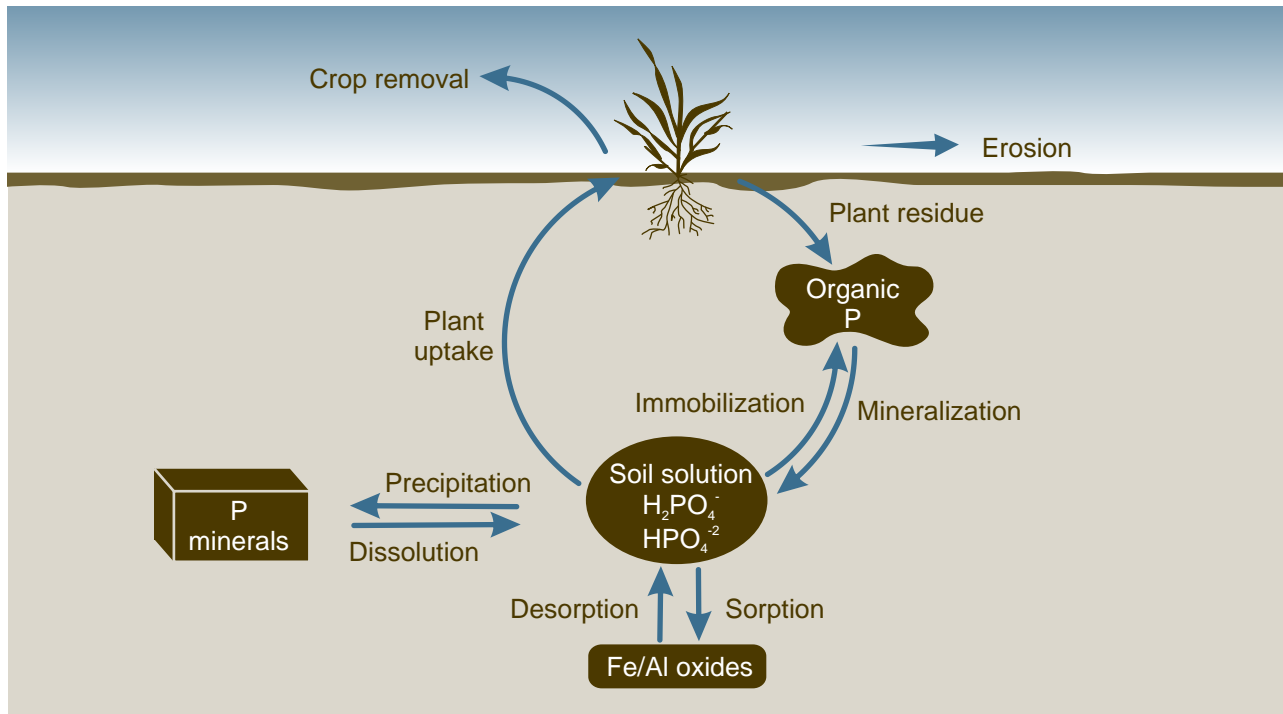

Adapted from Jones and Jacobsen 2002a

Figure 2.1.6 The Agricultural Phosphorus Cycle

P Cycling in Soils

Phosphorus exists in different pools in the soil. The P cycle, Figure 2.1.6, illustrates these pools and the pathways by which P may be taken up by plants or lost from the soil.

Phosphorus in soil exists in combination with other elements such as O and H. Plant roots absorb P mainly as orthophosphate (H_2PO_4^- or HPO_4^{2-}). The primary orthophosphate form (H_2PO_4^-) dominates in soils below pH 7.2, and the secondary form (HPO_4^{2-}) is prevalent in soils above pH 7.2. Plants are able to absorb the primary form more rapidly than the secondary form.

In soils, P occurs in three pools: soil solution, mineral and organic. Plants can only use P from the soil solution pool. The mineral and organic pools have stable components that change little with time (e.g., humus) and labile portions that gradually release P to the soil solution.

Phosphorus does not always “flow” toward the soil solution pool from the labile pool. It can move from the soil solution to the labile pools or even directly into stable soil components. Similarly, labile P can be tied up in non-labile organic and mineral compounds (Figure 2.1.7).

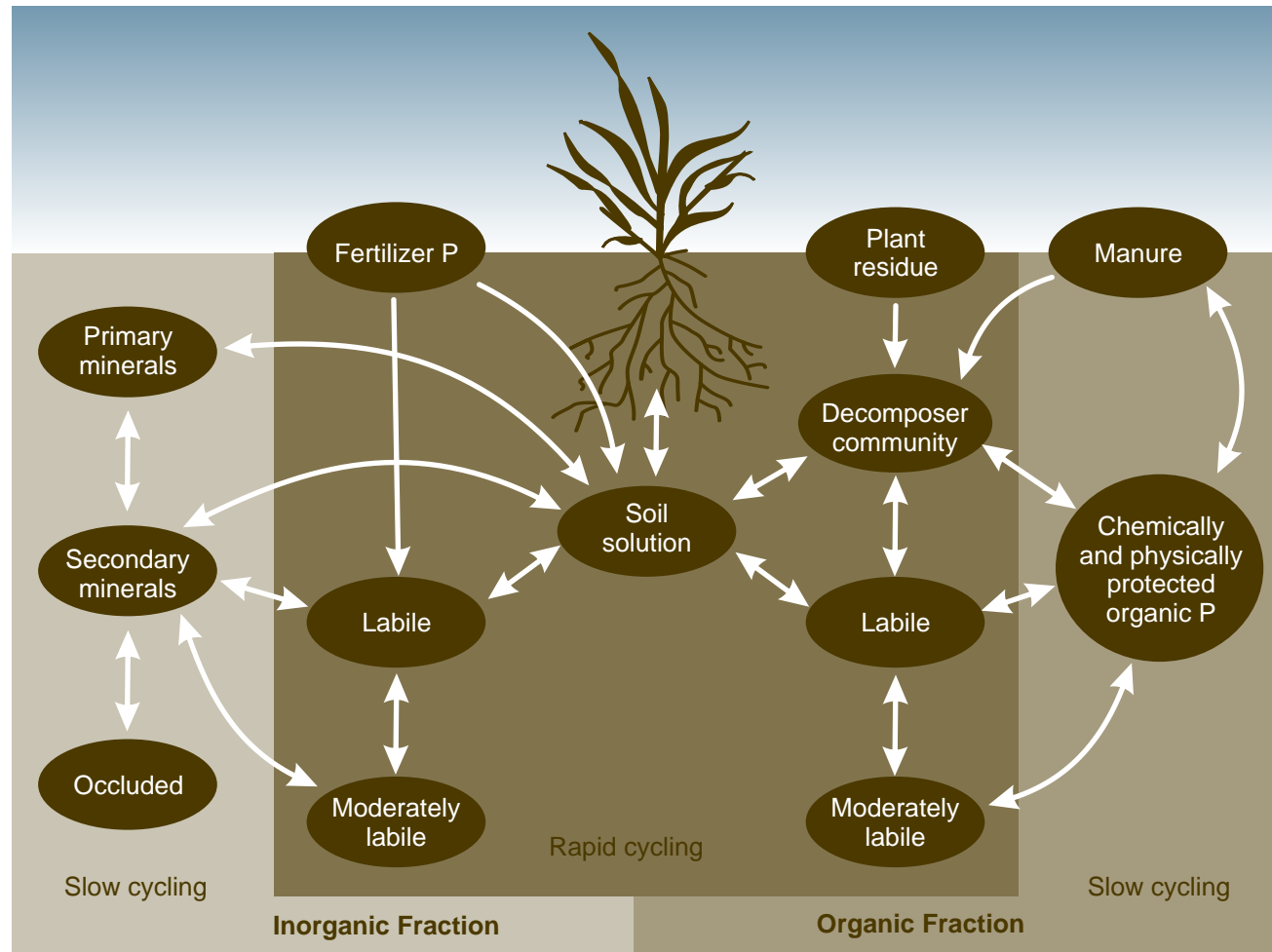

Created by Len Kryzanowski

Figure 2.1.7 Conceptual Relationship and Interactions Between Soil Phosphorus Pools

The amount of P in soil solution at any given time is usually low. Consequently, to meet crop requirements the P in soil solution is constantly replenished from the labile P. The rate at which labile P is converted to soluble P is more important than the total P content of the soil. Fertile soils can rapidly replenish P in soil solution, ensuring good crop growth.

The organic P pool comes from microbial, plant and animal residues deposited on or in the soil. Most of the organic pool is found in the top layers of soil and nearly half of this is in the form of phytic acid (Figure 2.1.8). Each molecule of phytic acid has the potential to release six molecules of orthophosphate (H_2PO_4^- or HPO_4^{2-}) to the soil solution.

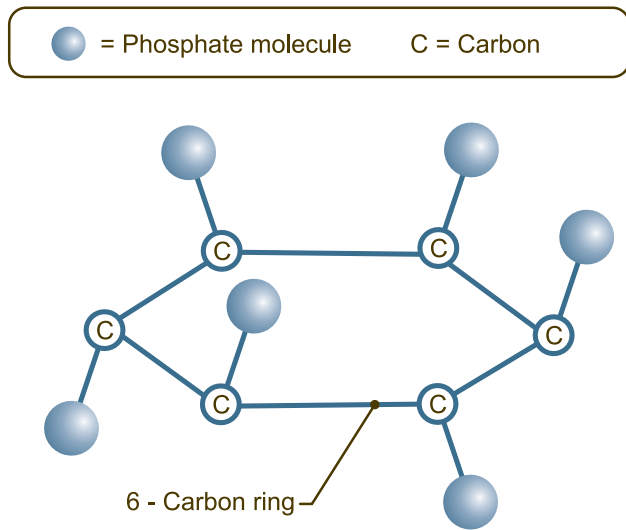

Figure 2.1.8 Phytic Acid

Phosphorus availability for plant uptake can be affected in a number of ways. For example, dissolved P in soil solution will react with soil constituents to form less soluble compounds. Sorption, or the retention of P on soil particles, makes P unavailable to plants for uptake. Sorption is thought to be the major mechanism responsible for decreases in soluble P. Desorption refers to P leaving soil particle surfaces and going back into solution.

Soil pH can also influence P availability. At high pH values (alkaline soils) Ca and Mg phosphates develop and at low pH values (acidic soils) aluminum and iron phosphates develop. These low-solubility products remove P from the soil solution since they are hundreds to millions of times less soluble than P fertilizers.

Water or wind erosion of topsoil is a major route of P loss. Soluble P can also be lost in surface runoff or through deep leaching under some circumstances. For example, when the P fixation capacity of the soil is exceeded and precipitation is greater than soil water

holding capacity, the result is a downward movement or surface runoff of orthophosphate and soluble organic P. Unlike N, there is no mechanism for gaseous P loss from soils.

Potassium

A small percentage of the total arable land on the prairies is K deficient. The highest proportion of these soils is in Alberta. Typically, the most severe deficiencies exist on the coarse textured (sandier) soils located within the Black, Dark Gray and Gray Luvisolic soil zones. The highest levels of plant-available K exist in the Brown and Dark Brown soil zones.

Unlike most essential nutrients, K is not an integral part of any plant structural component. However, it does play a role in many processes vital to plant growth. Among the functions of K in plants are enzyme activation, transport of sugars, plant water balance and regulation of stomata.

Potassium “activates” many different enzymes involved in plant growth. For example, photosynthesis as well as starch and protein synthesis are key pathways that rely on K-influenced enzyme systems.

The transport of sugars produced during photosynthesis also depends on K. Inadequate K can result in a build-up of photosynthetic products in the leaves, which can adversely affect the rate of photosynthesis and plant growth.

Potassium, along with sugars and other inorganic ions, influences the water balance within plants and helps to maintain an inward concentration gradient between roots and the soil solution. Potassium also influences the transpiration rate by controlling the size of the stomatal openings in response to environmental and internal plant conditions.



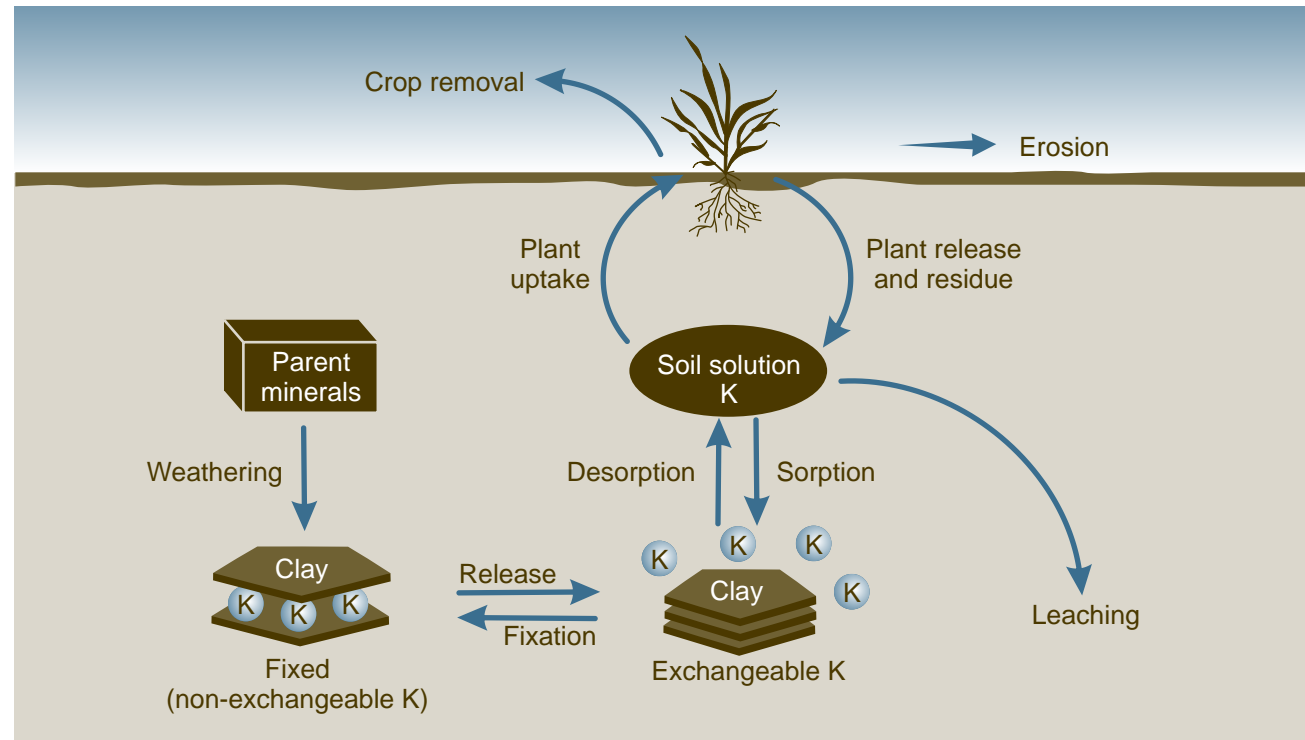

Adapted from Jones and Jacobsen 2002b

Figure 2.1.9 The Agricultural Potassium Cycle

K Cycling in Soils

The main pathways for K in the soil are shown in Figure 2.1.9. Potassium, much like P, exists in pools with differing abilities to replenish crop available K. In soil, K occurs in four pools: soil solution, exchangeable, fixed and parent minerals.

The soil solution and exchangeable pools of K are in equilibrium with each other. Plants absorb K exclusively as the K^+ ion, which is the only form that exists in soil solution. Exchangeable K refers to ions adsorbed to exchange sites on soil particles. It accounts for 1 to 2% of soil K. When K is removed from soil solution by

plant uptake it is replenished by K released from the exchangeable pool. Likewise, if the concentration of K in soil solution exceeds that in the exchangeable pool, K will adsorb to the exchange sites. This equilibrium ensures a steady pool of available K.

Potassium fixation is the entrapment of the K^+ ion in the structure of clay minerals. Fixation accounts for 1 to 2% of soil K (Figure 2.1.10). The fixed pool is not able to release K at rates sufficient to meet the demands of growing crops. However, a portion of this pool will become available as the exchangeable and soil solution K supplies are depleted.

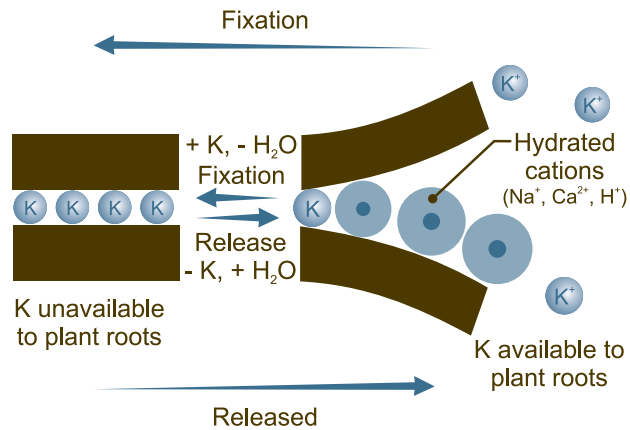

Adapted from Jones and Jacobsen 2002b

Figure 2.1.10 Release and Fixation of Potassium from Micas and Layered Clays

Greater than 90 % of the total K in prairie soils exists as part of the parent minerals: mica and feldspar. Release of K from these parent minerals occurs at a rate far too slow to meet the needs of growing plants.

There are two ways K can be lost from the system: leaching and erosion. Potassium leaching can occur on coarse textured soils that receive above average precipitation. In Alberta, however, K leaching losses are usually low because of the high cation exchange capacity of most soils and the dry climate. Erosion is a more important route of K loss.

Sulphur

Soil S levels can vary considerably within regions and even within fields. The switch to longer or continuous cropping rotations, particularly those that include canola (a high S user), has increased the occurrence of S deficiencies in Alberta.

Sulphur is essential for the conversion of NO_3^- to NH_4^+ in plants, and the synthesis of plant proteins. Sulphur is an integral part of plant processes, including N fixation in legumes, synthesis and functioning of chlorophyll, and oil formation in canola.

Sulphur requirements of crops remain high from germination through to grain filling because it is required to support vegetative growth and grain formation.

sidebar

In Alberta, salinity problems are often caused by sulphate salt accumulation (gypsum and epsom salts).



sidebar

N and S are closely related in soils worldwide with the ratio of N to S typically between 6:1 and 8:1.

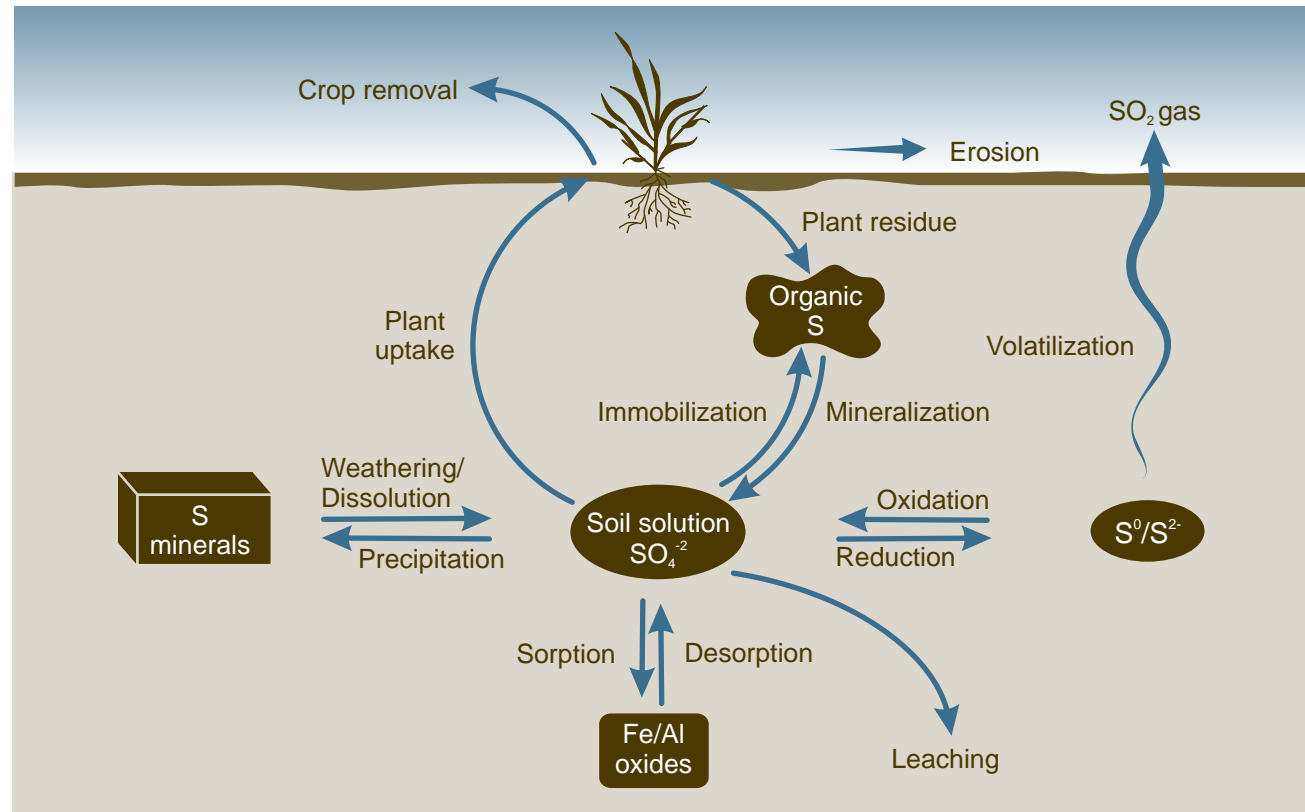

Adapted from Korb and Jacobsen 2002

Figure 2.1.11 The Agricultural Sulphur Cycle

S Cycling in Soils

Figure 2.1.11 represents the basic processes involving S in soils. Only 1 to 3% of the soil total S is in the plant-available form (SO_4^{2-}). The bulk of soil S (200 to 1100 kg/ha) is in soil organic matter. Mineralization of organic S compounds is an important source of S for growing plants.

The weathering of S-containing minerals such as gypsum (CaSO_4) can be a source of crop available S particularly in dry regions where the amount of precipitation is too low to leach it from the soil profile. Other primary and

secondary minerals will release elemental S (S^0/S^{2-}), which is converted to SO_4^{2-} when exposed to moisture, oxygen and microbial processes.

Crop available S (sulphate-sulphur) can become temporarily lost from soil solution through precipitation with magnesium or calcium (typical for Alberta) or adsorption to aluminum or iron oxides on clay particles. Sulphate-sulphur is soluble and mobile in soils and will move with groundwater. Leaching losses of S are possible, especially in coarse textured soils, but with average rainfall this type of loss will be low for most

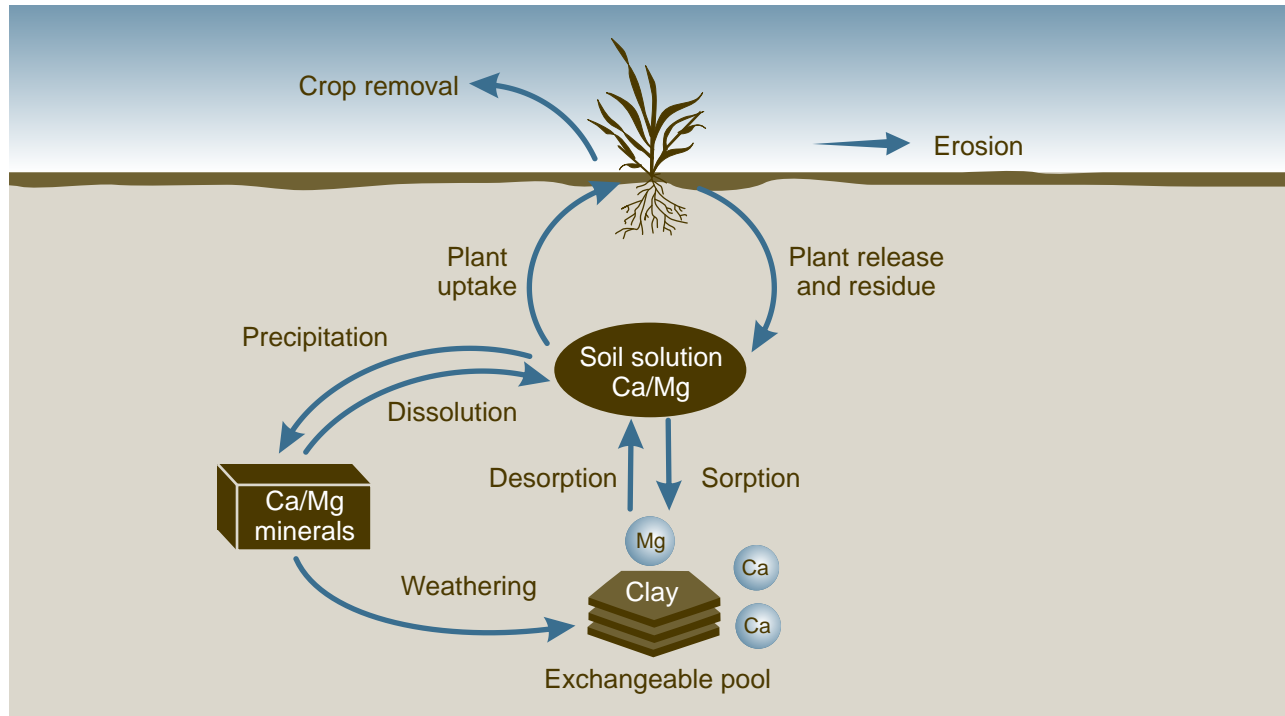

Adapted from Korb and Jacobsen 2002

Figure 2.1.12 Calcium and Magnesium Cycling

of Alberta. Volatile S losses can sometimes occur, but for most agricultural soils these losses are thought to be insignificant.

Calcium and Magnesium

Ca and Mg are essential for plant and animal growth. Most soils in Alberta have adequate supplies of Ca and Mg because the parent materials from which Alberta soils were developed are rich in these nutrients.

Calcium is a vital structural component of cell walls and influences membrane permeability. It also plays a role in N metabolism as it enhances plant uptake of NO_3^- . Other important functions of Ca include the movement

of carbohydrates and other nutrients within the plant and cell elongation and division.

Magnesium is a critical component of chlorophyll, and therefore essential for photosynthesis in the plant. It acts as a catalyst and co-factor for many important enzyme systems within plants and also appears to play a role in the production of oils and fats.

Ca and Mg Cycling in Soils

Figure 2.1.12 represents the basic processes involving Ca and Mg in soils. Plants absorb Ca and Mg as positively charged ions from the soil solution and they are replenished from the exchangeable pool. Weathering of Ca and Mg minerals with time results in crop available



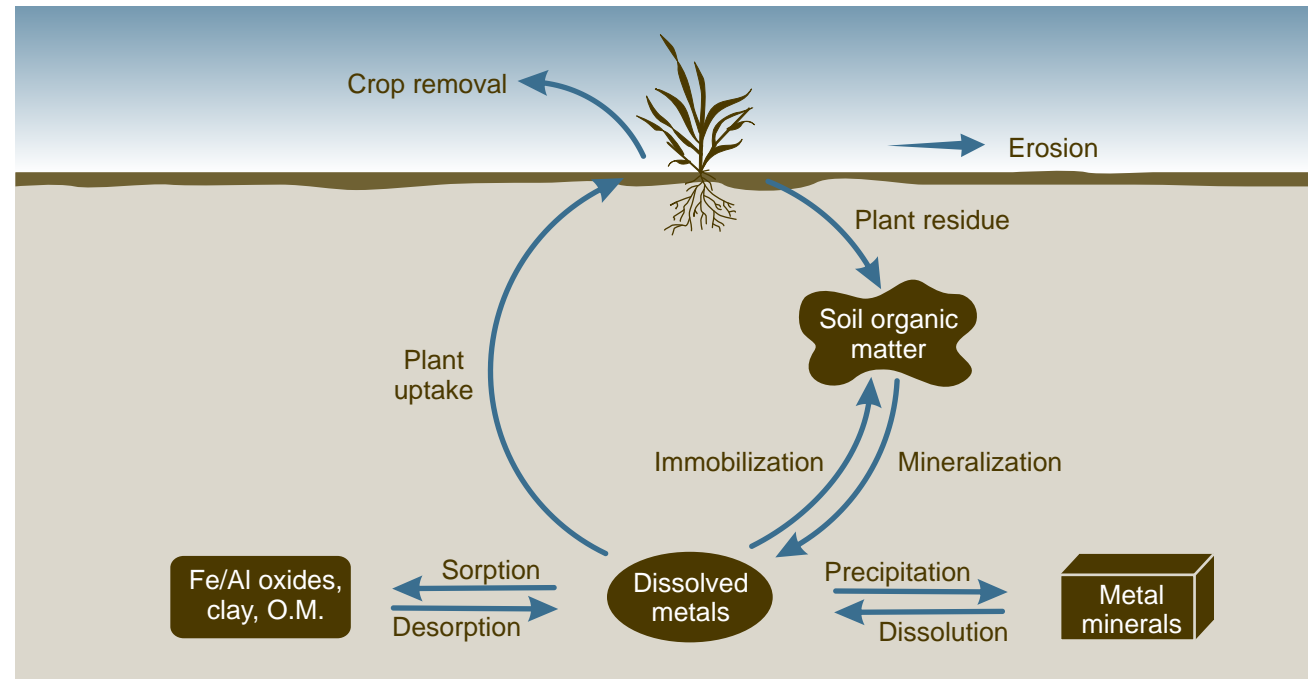

Adapted from Jones and Jacobsen 2003b

Figure 2.1.13 General Pattern of Micronutrient Cycles in Soils

Ca and Mg entering the exchangeable pool. Generally, there is less Mg in the soil solution than Ca. Even though plants require Mg in smaller amounts it is more likely to be deficient than Ca. This is partly because Mg binding to cation exchange sites is weaker than competing cations such as K^+ , Ca^{2+} , and NH_4^+ . Consequently, plants growing on soils with excesses of any of these cations are more likely to show symptoms of Mg deficiency. Erosion is the main route of Mg and Ca loss from the soil.

Micronutrients

Although micronutrients (Cl, Fe, Mn, Zn, B, Cu, and Mo) are required in “micro” quantities, they are significant in terms of their contribution to plant growth.

Soil characteristics can influence micronutrient availability. Clay soils are less likely to be deficient in micronutrients than sandy soils. Soils with low (i.e., less than 1 to 2%) or very high organic matter content (i.e., greater than 30%) often have low levels of micronutrient availability. As soil pH increases, availability of micronutrients tends to decrease. The exception is molybdenum whose availability increases with soil pH. Most soil micronutrient cycles follow much the same general pattern as in Figure 2.1.13.

Inorganic micronutrients occur naturally in mineral soils. As parent minerals break down during soil formation, micronutrients slowly become available to plants. Organic matter is also an important source of micronutrients. Microbial decomposition helps to release micronutrients into plant-available forms.

Table 2.1.3 summarizes key characteristics of each of the essential micronutrients.

Table 2.1.3 Summary of Plant Micronutrient Characteristics

Micronutrient	Form Taken up by Plant	Function in Plants	Comments
Chlorine (Cl)	Cl ⁻ ion	Associated with the suppression of leaf and root diseases.	Added to soil when potash (KCl) is applied.
Iron (Fe)	Fe ²⁺ /Fe ³⁺ ion	A vital constituent of chlorophyll. Important for oxygen transfer within the plant system. Important for the formation/activity of respiratory enzymes.	Deficiency not observed in Alberta field crops, but common in trees, shrubs and ornamentals in southern Alberta.
Manganese (Mn)	Mn ²⁺ and as a component of organic complexes	Seems to play a role in the uptake of other nutrients and the activation of a number of enzyme systems.	Mn toxicity more common than deficiency.
Zinc (Zn)	Zn ²⁺ and as a component of organic complexes	Plays a role in the formation of growth promoting compounds, carbohydrate transformations, regulation of sugar consumption, and is a constituent of several enzyme systems.	Deficiencies are most likely on calcareous, light textured, high pH soils that are high in P content.
Boron (B)	Primarily boric acid (H ₃ BO ₃)	Maintains plant cell wall integrity.	Deficiencies suspected in some canola crops grown in Alberta.
Copper (Cu)	Cu ²⁺ and as a component of organic complexes	Essential for production of Fe-containing compounds. Facilitates synthesis of chlorophyll. Influences several metabolic reactions.	Coarse-textured black soils are often associated with deficiency.
Molybdenum (Mo)	MoO ₄ ²⁻	Enhance plant uptake of N, K, and Ca required by legumes for fixation of atmospheric N by nodular bacteria. Assists in making Fe plant available.	Minimal evidence of confirmed Mo deficiencies in western Canadian field crops.



➔ summary

- There are sixteen mineral and non-mineral nutrients essential for plant growth. The non-mineral nutrients—carbon, hydrogen and oxygen—are taken up from air and water. The mineral nutrients are taken up **from the soil and are classified as macro- or micronutrients**: nitrogen, phosphorus, potassium, sulphur, calcium, magnesium (macronutrients), chlorine, iron, manganese, zinc, boron, copper and molybdenum (micronutrients).
- The law of the minimum states that crop productivity will be limited by the nutrient that is in shortest supply relative to its requirement.
- Plants absorb ions from the soil through **root interception, mass flow, and diffusion. Of these processes, mass flow is responsible for the majority of nutrient uptake.**
- Nutrients exist in several pools. The crop available and exchangeable pools are most critical for meeting short-term crop needs.
- In most nutrient cycles the basic processes occurring are mineralization, immobilization, sorption, precipitation, weathering and losses.

Chapter 2.2

Basic Soil-Plant Interactions



➔ learning objectives

- Describe the process of cation exchange in soils and its implications for crop nutrition.
- **Briefly explain the importance of soil organic matter for crop production.**
- Describe how acid soil conditions can limit crop growth.
- Explain how salinity can limit crop growth.



This chapter will discuss soil characteristics and processes that influence plant nutrient availability including: ion exchange in soils, organic matter, pH (acidity and alkalinity), and salinity.

Important Terms

Table 2.2.1 Key Terms and Definitions

Term	Definition
Aerobic	The presence of oxygen.
Aggregate	A soil structure unit formed from primary soil mineral particles (sand, silt, clay) and organic matter that are grouped together.
Anaerobic	The absence of oxygen.
Anion	An atom or group of atoms (e.g., a molecule) with a net negative charge.
Base Saturation	Is the percentage of total cation exchange capacity occupied by base cations such as calcium, magnesium, sodium and potassium.
Buffering Capacity	The resistance of a soil to change in pH.
Calcium Carbonate Equivalent	The carbonate content of a liming material that is calculated as if all the carbonate is in the form of calcium carbonate.
Cation	An atom or group of atoms (e.g., a molecule) with a net positive charge.
Cation Exchange Capacity	The capacity of a soil for exchange of positively charged ions between the soil and the soil solution.
Ions	Are atoms or groups of atoms (e.g., a molecule) that carry an electrical charge due to the loss or addition of one or more electrons.
Osmotic Stress	The adverse response of a plant to a high salt concentration in the soil relative to the plant.
Saline Seep	Intermittent or continuous saline discharge at or near the soil surface under dryland conditions.
Salt Index	Expresses a fertilizer's potential to cause salt injury in germinating seedlings. It is based on a relative rating to sodium nitrate that is assigned an index value of 100.
Soil Solution	The liquid phase of the soil and its solutes, consisting of ions dissociated from the surfaces of the soil particles, and other soluble materials.
Tilth	The physical condition of the soil, especially in relation to its suitability for tilling, planting or growing a crop.

Ion Exchange in Soils

Ion exchange is the movement of ions (charged nutrients) between soil particle surfaces and the soil solution. It is the most critical soil process that affects crop nutrient availability.

Soil particle surfaces carry static electric charge. While soil particle surfaces can have both positive and negative charges, most Alberta soils carry a net negative charge. The location where ions interact with a charged soil particle is called an exchange site. Negatively charged exchange sites attract positively charged ions (cations) such as potassium

(K⁺) or calcium (Ca²⁺) and positively charged sites attract negatively charged ions (anions) such as nitrate (NO₃⁻) and chloride (Cl⁻).

Adsorption retains nutrients in the root zone making them easily accessible to growing crops. Adsorbed cations are loosely held to the negatively charged surfaces of soil particles. This association is strong enough that adsorbed ions resist being leached by the downward movement of water through the soil profile. However, it is also weak enough for adsorbed ions to be replaced by other cations in soil solution. This substitution, known as cation exchange, occurs largely through competition between ions for the negatively charged exchange sites on the particle surface. The common cations in soil are listed below, in order of increasing adsorption strength:



The amount of exchangeable cations per unit weight of soil (on a dry basis) is referred to as cation exchange capacity (CEC). It estimates the number of exchange sites in a given soil sample that would be capable of holding positively charged crop nutrients. The larger the CEC, the more cations the soil can hold. Increasing the organic matter content of soils with low clay content will help to increase the CEC. Managing soil pH will also help optimize the CEC.

Soil Fertility Implications of CEC

Two soil characteristics related to CEC are base saturation and buffering capacity. Base saturation refers to the percentage of the CEC occupied by K⁺, Ca²⁺, Mg²⁺, and Na⁺. Soils with higher percent base saturation have higher levels of available K⁺, Ca²⁺, and Mg²⁺ for growing crops.

Buffering capacity refers to the ability of a soil to replenish ions in soil solution. Soils with a high buffering capacity usually have large amounts of clay and organic matter. Soils with lower buffering capacity have a limited ability to replenish nutrients; therefore, they require more frequent nutrient additions to maintain fertility.

Organic Matter

Soil organic matter consists of materials, such as animal and plant residues, at various stages of decay. The organic matter content of a soil depends on the balance of two activities—the addition of organic residues to the soil and the decomposition of residues by soil macro- and microorganisms (Figure 2.2.1). The result of decomposition is a dark, stable end product (i.e., it does not change much with time) called humus. Over the long-term, however, all nutrients found in soil organic matter are converted into simple end products such as carbon dioxide, water and nutrients.

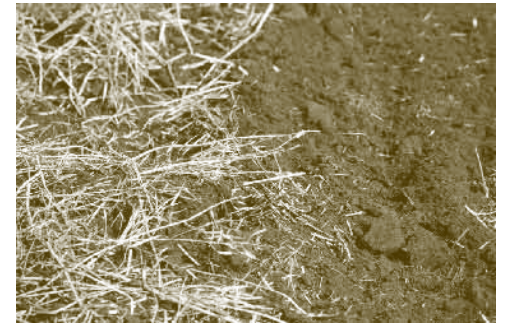

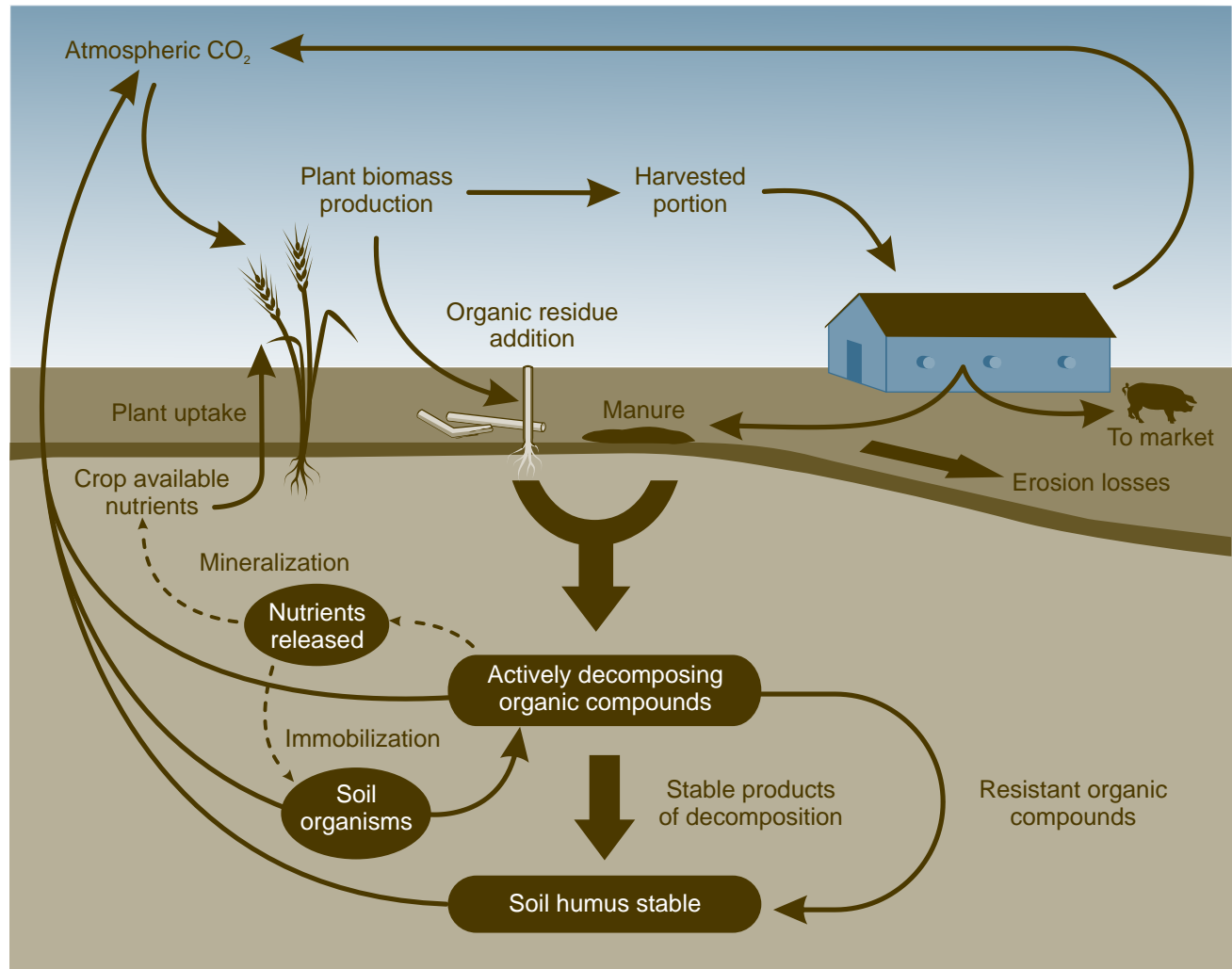

Figure 2.2.1 The Agricultural Organic Matter Cycle

Created by Len Kryzanowski

Generally, the environmental factors that influence plant growth also impact the activity of soil organisms and the rate of organic matter decomposition. These factors — aeration, moisture, temperature, and nutrient availability — are described in more detail below:

- Decomposition is an aerobic process (i.e., requires oxygen). Soil conditions that limit aeration (e.g., water logging, compaction) will slow decomposition.
- Decomposition is optimal when the soil is near or slightly wetter than field capacity. Extreme moisture conditions (i.e., too dry or too wet) can impede decomposition.
- Optimal soil temperature for decomposer microbes is in the range of 25 to 40°C. Soil temperatures in Alberta are typically below this range; therefore, decomposition is much slower during spring and fall.
- Soil organisms have specific nutrient requirements to function. Microbial growth will be limited if any nutrient is lacking in the system, resulting in a reduced rate of decomposition.

The rate of decomposition varies through the year, between years and even across the landscape as environmental factors change.

Carbon to Nitrogen (C:N) Ratio: Organic Matter Cycling and Nutrient Release

The C:N ratio in soils and residues has a significant impact on decomposition and nutrient release. The C:N ratio in soils is about 10:1. Adding organic residues to the soil changes the C:N ratio. Decomposition is slowed when C:N ratio is high (greater than 30:1) and rapid when C:N ratio is low (less than 20:1). Generally, N is released when C:N is less than 20:1, and N is immobilized when C:N is greater than 30:1 (Figure 2.2.2).

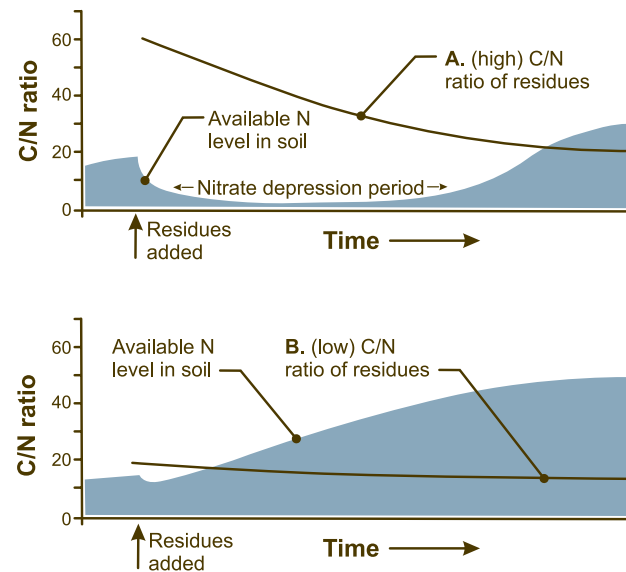

Adapted from Brady and Weil 2000

Figure 2.2.2 Effect of (A) High and, (B) Low C:N Ratio in Added Organic Residues on Soil Available N Level

Management Factors That Influence Organic Matter

Cultivation has the largest impact on soil organic matter content (Table 2.2.2). This management practice accelerates the loss of soil organic matter because:

- Cultivation aerates the soil and this promotes the activity of decomposer organisms.
- Bare soil warms faster in the spring and this increases the activity of soil organisms and creates a wider window for decomposition during the growing season.
- Cultivation reduces ground cover and this increases the risk of soil erosion. Surface soil is the most susceptible to loss and contains the majority of soil organic matter.
- Cultivation physically mixes crop residues into the soil where decomposition occurs.

side bar

Cultivating fallow repeatedly promotes decomposition and organic matter loss throughout the season. Reducing tillage helps to preserve soil organic matter.



sidebar

An advantage of manure application (primarily solid manure) to soil is that it directly and indirectly contributes to soil organic matter. In contrast, commercial fertilizers indirectly contribute to soil organic matter by increasing crop yield and residue.



Table 2.2.2 Changes in Organic Matter Content (%) of Alberta Soils Due to Cultivation

Condition	% Organic Matter in Alberta Soil Zones				
	Black	Dark Brown	Brown	Dark Gray	Gray
Native state	6-10	4-6	4-5	4-5	1-2
Under cultivation	4-6	3-4	2-3	2-3	1-2

Source: Lickacz and Penney 2001

Management practices that help build soil organic matter include applying solid or composted livestock manure, more root and above ground crop residue production, reduced tillage, continuous cropping, direct seeding, avoiding straw removal, green manuring and perennial forage production. Optimizing soil fertility can also help build soil organic matter. Healthy, vigorous crops provide denser ground cover, which reduces the risk of erosion. High yield crops also leave greater volumes of organic residues in the form of roots, stems and other unharvested materials.

Soil Fertility Implications of Organic Matter

Organic matter has a large influence on soil fertility for crop production. It exerts this influence in several ways:

- It is an important source of nutrients required by crops and is a critical component of nutrient cycling in soils. Organic matter can be described as a “revolving nutrient bank account”.
- It increases cation exchange capacity of soils by providing a large number of additional exchange sites (Figure 2.2.3). This additional exchange capacity is pH dependent.

- It improves soil structure, aggregate stability (measure of ability for soil particles to withstand disintegration) and tilth. These properties increase water infiltration and reduce water erosion, which is a significant mode of nutrient and organic matter loss.

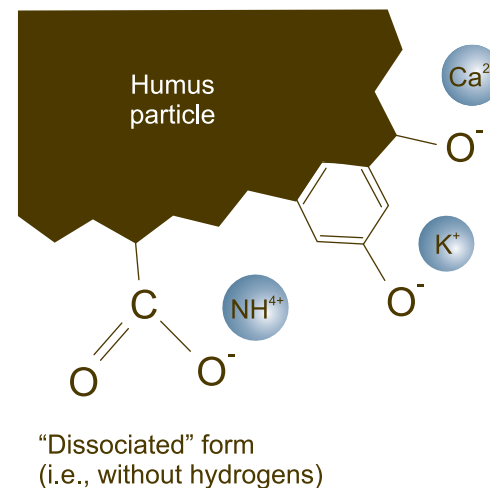

Adapted from Brady and Weil 2000

Figure 2.2.3 Chemical Groups in Organic Matter Responsible for the High CEC of Organic Matter

pH

The pH of a soil is a measure of the concentration of hydrogen ions (H^+) in soil solution. It is expressed on a logarithmic (power of 10) scale, which ranges from 1 to 14. A one-point change on the pH scale represents a 10-fold change in the acidity of a solution (e.g., a solution with pH 4 has 10 times the concentration of hydrogen ions than a solution with a pH of 5 and 100 times more than a solution with a pH of 6).

A neutral soil has a pH near 7. Acidic soils have a pH of less than 6, while basic or alkaline soils have a pH greater than 7. Crops differ in their tolerance to pH conditions, but most crops grown in Alberta prefer a pH in the range of pH 6.5 to 7.

Soil Fertility and Management Implications of pH

There are several ways that pH affects soil fertility and management:

- Microorganisms involved in nutrient cycling are sensitive to large shifts in pH. Nutrient cycling is slowed or stopped if microbial populations are affected.
- Soil pH affects nutrient solubility and can alter the form and availability of nutrients (Figure 2.2.4). Under low pH conditions, some nutrients become less available to plants because their chemical structure changes (e.g., P). In other cases, nutrients become unavailable because they bind tightly to soil particles.

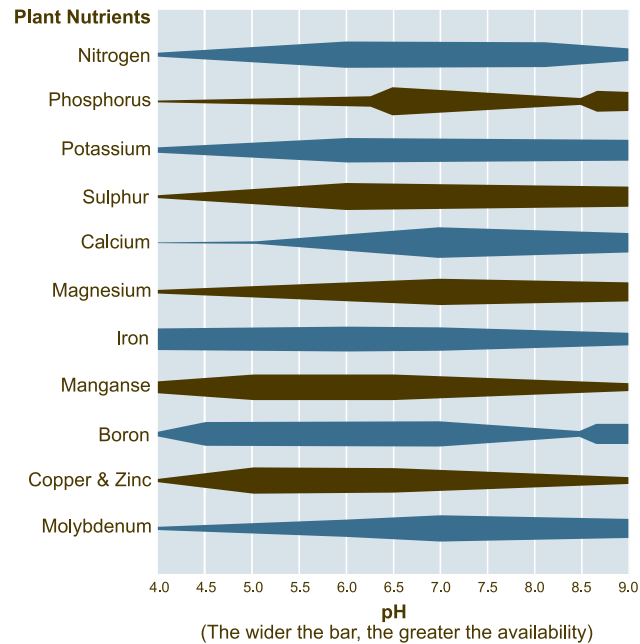

Source: AF

Figure 2.2.4 Nutrient Availability as Affected by pH

- Low pH conditions reduce soil base saturation by displacing plant nutrients (e.g., Ca^{2+} and K^+) from exchange sites with H^+ and soluble aluminum (Al^{3+}) ions. Nutrients displaced from exchange sites can be lost or leached from the system and are no longer available to plants.
- Plant species vary in their acidity tolerance (Figure 2.2.5). This is strongly influenced by a plant's sensitivity to levels of soluble aluminum (Al^{3+}), which increases substantially under acidic conditions.
- Crops produced in soils outside their acidity tolerance range will result in reduced yields. Under acidic conditions, nutrient requirements should be adjusted on the basis of crop type and pH level for anticipated reduced yield potential.

sidebar

To contend with soil acidity, choose acid tolerant crops or consider liming the soil.



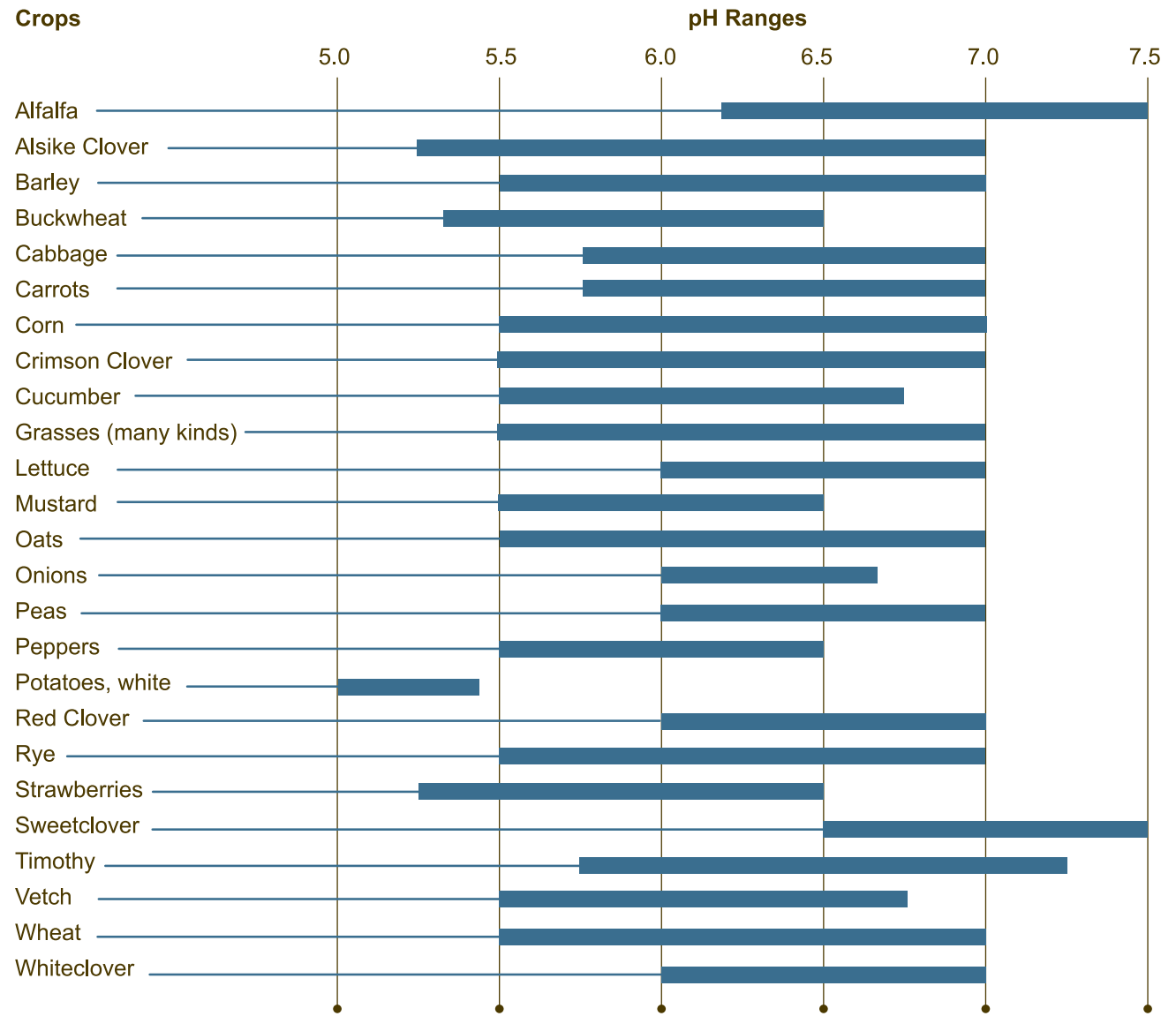

Source: Haulin et al. 2005

Figure 2.2.5 pH Tolerance Ranges for Selected Crops Grown in Alberta

Acidifying Effect of Fertilizers and Manure

Aside from the obvious boost in crop available nutrients, fertilizer application can also impact soil pH (Figure 2.2.6). The nitrification of ammonium from fertilizers, plant residues or manure will acidify soil.

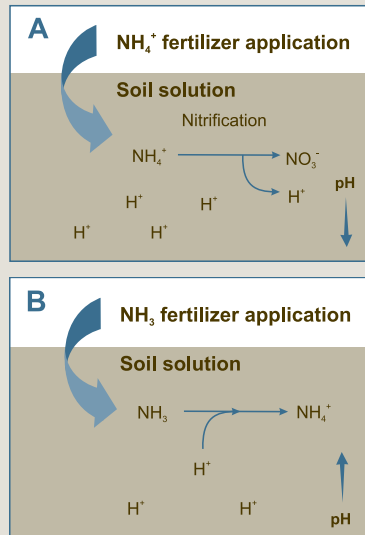

Source: McCauley et al. 2003

Figure 2.2.6 Effect of Ammonium Addition on Soil pH

Soil acidification can be beneficial on alkaline soils, but detrimental on acidic soils. It is important to select an appropriate form and rate of fertilizer based on the soil pH conditions.

The relative acidity of fertilizer refers to the amount of calcium carbonate (kg) required to neutralize the acid formed from the application of 100 kg of the fertilizer. Note, that the relative acidity is based on total weight of fertilizer applied and not weight of nutrient applied. Based on a weight of applied nitrogen the relative acidity of some fertilizers is:

Ammonium Sulphate >>>> Urea = Anhydrous Ammonia

Table 2.2.3 Relative Acidity of Several Commonly Used Fertilizers

Fertilizer	Relative Acidity (kg $\text{CaCO}_3/100\text{kg}$)
Anhydrous Ammonia	148
Urea	84
Ammonium Sulphate	110
Urea-ammonium Nitrate	52
Monoammonium Phosphate	65
Potassium Chloride	0
Potassium Sulphate	0
Gypsum	0

Source: McCauley et al. 2003

Salinity

Soil salinity describes areas where soils contain high levels of salt. In western Canada, compounds responsible for soil salinity include sulphate salts of sodium, calcium and magnesium (Na_2SO_4 , CaSO_4 , and MgSO_4 , respectively). Soil salinity is a serious soil quality issue in Alberta affecting more than 640,000 ha (1.6 million acres).

Saline soils have high concentrations of soluble salts in the surface soil layers. Excess salt impairs the ability of plants to efficiently absorb water and nutrients from the soil. By keeping the ion concentration in the root sap higher than in the soil water, plants can maintain an inward flow of water into their roots. However, higher concentrations of salt ions in soil solution shift the concentration gradient creating osmotic stress (Figure 2.2.7). Plants in osmotic stress use more energy to maintain an inward flow of water into their roots. As a result, less energy is available for tissue growth and crop yields are reduced.

side bar

Liming acid soils is an ion exchange reaction. It has the net effect of raising pH, restoring the buffering capacity, and increasing base saturation.



s i d e b a r

Solonetzic soils are not classified as saline, but are characterized by excessive levels of exchangeable sodium.

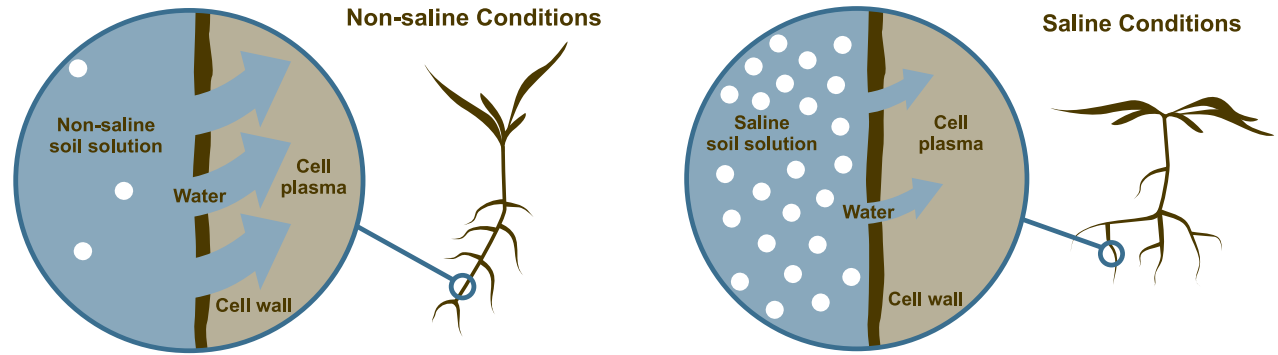

From Seelig 2000

Figure 2.2.7 The Impact of Soil Salinity on Water Uptake by Plants

The measure of soil salinity is electrical conductivity (EC), which is measured in decisiemens per metre (dS/m). Electrical conductivity reflects the total soluble salt concentration in the soil. Soil salinity can be determined in a laboratory by taking a water extract of a soil sample and measuring the conductivity in the extract using an EC meter. Salinity can also be measured in the field using an EM38 apparatus.

Salt affected soils are classified as saline, sodic or saline-sodic based on soluble salt content in the soil and the percentage of exchange sites occupied by sodium ions. Saline soils have an excess of soluble salts and sodic soils have high levels of exchangeable sodium. Saline-sodic soils are characterized by both problems.

Salinity is often placed into one of two categories: dryland salinity and irrigation salinity. Dryland salinity is caused by groundwater redistributing salts and accumulating these at the soil surface. When groundwater moves from upland to lowland areas, it accumulates salts and raises the water table in the lowlands (Figure 2.2.8). When the water table comes within two metres of the soil surface, capillary action raises the groundwater to the soil surface. When the water evaporates, salts accumulate in the root zone and topsoil (Figure 2.2.9). Dryland salinity is further influenced by activities of agriculture and land management.

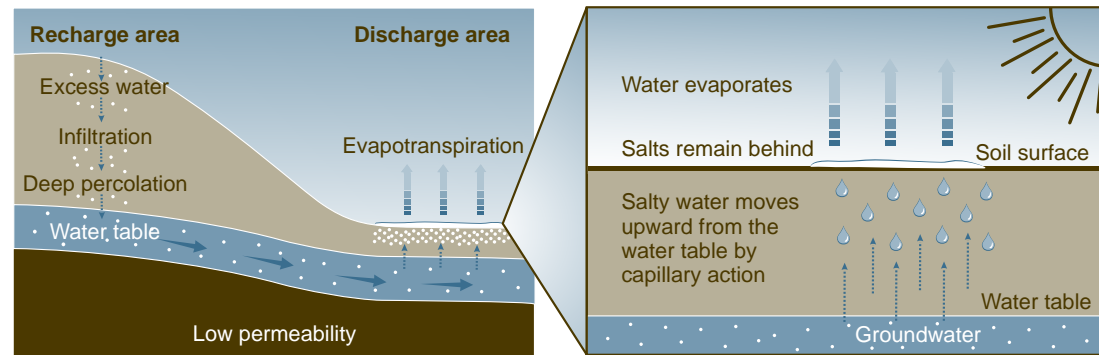

Adapted from Wentz 2000

Figure 2.2.8 Generalized Saline Seep Formation



Photo courtesy AAFRD

Figure 2.2.9 Saline Seeps with Saline Groundwater on Surface

Irrigation salinity occurs when the salts from irrigation water are not sufficiently leached from the root zone. This is a problem in soils with poor drainage. Irrigation salinity can also result from excess water applications that raise ground water and dissolved salts into the root zone. As with dryland seeps, dissolved salts are left behind as water in the surface soil evaporates.

Soil Fertility Implications of Salinity

There are several ways that soil salinity affects fertility:

- Salinity reduces yield potential and therefore crop nutrient demand. The general reduction in crop yield on salt affected soils in Alberta has been estimated at 25%. Fertilizer and manure application should be adjusted to reflect this reduced yield potential.
- Salinity can cause nutrient imbalances as a result of high concentrations of salt ions in the soil. For example, excess sodium can lead to deficiencies in magnesium and calcium.
- Saline soils tend to have alkaline pH, which also affects nutrient availability.
- Sodic soils have structural problems that limit yield potential. Fertilizer and manure application should be adjusted to reflect these limitations.

Sodic Soils Quick Fact

Sodic soils contain high levels of exchangeable sodium. This reduces the ability of soil particles to cling together in stable soil aggregates. When wetted by precipitation or irrigation water, the soil aggregates in these soils easily break apart and puddling can occur. When the puddles dry, a solid crust develops on the soil surface. This crust can inhibit water and oxygen infiltration, as well as crop emergence, resulting in bare patches in fields.

Soil Salinity and AOPA

Manure has the potential to increase soil salinity because it contains 4 to 10% salt (depending on the species, diet formulation and salt content of the drinking water). This is a particular risk for fields that receive regular applications of manure and limited precipitation.

AOPA sets restrictions on manure application based on salinity. Manure cannot be applied in quantities that would raise the EC of the soil more than 1 dS/m after application. Furthermore, manure cannot be applied to soils with an EC measurement of 4 dS/m or more unless approved by the NRCB.

“Salt Effect” of Fertilizers

High rates of seed placed fertilizer can damage seeds and seedlings. One reason for this is the salt effect of fertilizer (i.e., fertilizer mimics the effect of soil salinity).

The potential of fertilizer to influence the salt level in soil solution is expressed as its salt index (SI). The higher the fertilizer SI, the greater the risk of salt burn to germinating seedlings (Table 2.2.4).

The SI is based on equivalent product weights rather than actual nutrients supplied. For example, urea (46% N) has about half the salt effect of ammonium sulphate (21% N) when applied at equivalent rates of N.

sidebar

Canal seepage is a form of irrigation salinity caused when water seeps from irrigation canals or drainage ditches. Because many canals are located along a topographic break, canal seepage can exaggerate natural salinity.



Table 2.2.4 Salt Index (SI) for Various Fertilizers

Fertilizer	SI ($\text{NaNO}_3 = 100$)
Anhydrous Ammonia	47.1
Urea	74.4
Ammonium Sulphate	68.3
Urea-ammonium Nitrate	63.0 (28-0-0) 71.1 (31-0-0)
Monoammonium Phosphate	26.7
Ammonium Polyphosphate	20.0
Potassium Chloride	120.1
Potassium Sulphate	46.0

Sources: Mortvedt 2001, McCauley et al. 2003

→ summary

- Positively charged ions (cations) are attracted and loosely held (adsorbed) to the negative charge of soil particles.
- Adsorbed cations can be exchanged for others in a process called cation exchange. The amount of exchangeable cations per unit weight of soil is referred to as the CEC.
- Cation exchange is a critical process for supplying nutrients to developing crops.
- Organic matter is an important source of nutrients. Soil organic matter content **influences CEC and can be influenced** by environmental conditions and management practices.
- Soil pH affects the availability of several nutrients essential for crop growth and **development and also influences the activity of soil organisms.**
- Salinity can limit crop growth by interfering with plant water uptake. This reduces yield potential and should factor into nutrient management.

Chapter 2.3

Manure and Fertilizer as Sources of Nutrients and Potential Environmental Hazards



➔ learning objectives

- Describe the advantages and disadvantages of fertilizer and manure as sources of nutrients for crop production.
- Summarize the risks of improper manure and fertilizer management for soil, water and air quality.



Important Terms

Table 2.3.1 Key Terms and Definitions

Term	Definition
Crop Available or Available Nutrient	A nutrient in a chemical form accessible to plant roots or compounds likely to be converted to such forms during the growing season.
Inorganic Nutrients	Nutrients that are not bound to organic carbon. These nutrients can be readily absorbed and used by plants.
Organic Nutrients	A form of nutrient that is bound to organic carbon and cannot be readily absorbed and used by a plant. Organic nutrients require a physical or chemical conversion to an inorganic form prior to use.
Soil Organic Matter	Consists of living or dead plant material, organisms, products derived from microbial and animal metabolism and stabilized complex organic material called humus. As organic matter breaks down (mineralized) nutrients are released in a form that plants can use.
Pore Space	This is the 'space' between soil particles or the total space not occupied by soil particles in a bulk volume of soil.

Manure and fertilizers are important sources of nutrients for crop production in Alberta. However, improper management can negatively impact environmental quality and human health. One of the primary reasons for developing a NMP is to maximize the benefits of manure and fertilizer application, while minimizing environmental risk.

Manure and Fertilizer as Sources of Nutrients

Fertilizers and manure are important sources of nutrients for crop production. To maximize the benefits of both, it is important to recognize how they differ.

Fertilizer

Using commercial fertilizers is less complicated than using manure for several reasons:

- The nutrient content of fertilizers is standardized and consistent. Manure, in contrast, can vary considerably in nutrient content creating difficulties for accurate nutrient applications.
- Fertilizers and soil test recommendations express nutrient content in the same way; percent N, P_2O_5 , and K_2O for nitrogen, phosphorus and potassium respectively. Manure values for these nutrients are expressed as percent total N, P and K. To avoid errors in calculating application rates, manure nutrient values must be converted to the same chemical form as reported in soil test recommendations (N, P_2O_5 , and K_2O).
- Fertilizers contain simple inorganic forms of nutrients that are readily available to plants. In contrast, manure contains organic and inorganic nutrient forms with varying plant availability. This makes it difficult to estimate nutrient availability from manure and appropriate manure application rates to meet nutrient demands in the year of application.

- To help avoid over-application of nutrients, fertilizers can be custom blended to produce nutrient proportions based on soil test fertilizer recommendations. Manure has an imbalanced nutrient profile relative to what most crops require. This can lead to over or under-application of nutrients and increase environmental risk or reduced yield, depending on the nutrient.
- All nutrient applications have nuisance concerns such as odour, dust and noise. Unlike manure, odour is not an issue with fertilizer application.
- Fertilizers are a more concentrated source of nutrients on a weight basis. Higher nutrient concentration reduces product bulk. This reduces transportation costs per weight unit of nutrient and facilitates easier storage.



Table 2.3.2 summarizes the properties of fertilizers commonly used in Western Canada.

Table 2.3.2 Characteristics of Fertilizers Commonly Used in Western Canada

Fertilizer	% N-P ₂ O ₅ -K ₂ O (S)	Forms of Key Nutrients	Comments
Anhydrous Ammonia	82-0-0	NH ₃ /NH ₄ ⁺	<ul style="list-style-type: none"> Highest N content of all N fertilizers.
Ammonium Sulphate	21-0-0-24S	NH ₄ ⁺ , SO ₄ ²⁻	<ul style="list-style-type: none"> Most common S fertilizer used in Alberta.
Urea	46-0-0	NH ₃ /NH ₄ ⁺	<ul style="list-style-type: none"> Most popular form of granular N fertilizer used in Alberta.
Urea-Ammonium Nitrate	28-0-0/32-0-0	NH ₃ /NH ₄ ⁺ , NO ₃ ⁻	<ul style="list-style-type: none"> Most common liquid N fertilizer. Half of the N is from urea and half is from ammonium nitrate.
Monoammonium Phosphate	12-51-0	NH ₄ ⁺ , HPO ₄ ²⁻ or H ₂ PO ₄ ⁻	<ul style="list-style-type: none"> Most popular P fertilizer used in Alberta. Often blended with potash.
Ammonium Polyphosphate	10-34-0	NH ₄ ⁺ , HPO ₄ ²⁻ or H ₂ PO ₄	<ul style="list-style-type: none"> Most common liquid P fertilizer.
Muriate of Potash	0-0-60	K ⁺ , Cl ⁻	<ul style="list-style-type: none"> Saskatchewan is the world leading producer of potash.
Urea-ammonium Sulphate	34-0-0-11S	NH ₃ /NH ₄ ⁺ , SO ₄ ²⁻	<ul style="list-style-type: none"> Not common in western Canada.
Ammonium Phosphate-sulphate	16-20-0-14S and 17-20-0-15S	NH ₄ ⁺ , HPO ₄ ²⁻ or H ₂ PO ₄ ⁻ , SO ₄ ²⁻	<ul style="list-style-type: none"> Primarily a home and garden fertilizer.
Sulphur Bentonite	0-0-0-90S	S ⁰ /S ²⁻	<ul style="list-style-type: none"> Contains 10% bentonite clay. Can be blended with most other fertilizers. To be plant available, microorganisms must oxidize elemental S.
Gypsum	0-0-0-18S	SO ₄ ²⁻ , Ca ²⁺	<ul style="list-style-type: none"> Lower solubility than ammonium sulphate. Supplies Ca²⁺.

sidebar

The impact of manure application on soil organic matter is influenced by the solids content of the manure (solid manure has a greater influence than liquid manure).



Manure

The following are some favourable characteristics of manure as a nutrient source:

- In most cases, manure is available for free or minimal cost. However, trucking and application costs can minimize this advantage.
- Manure can serve as a soil conditioner through the addition of organic matter. This can improve the physical structure and stability of soils, particularly degraded soils and those with low organic matter.
- Manure has a broad profile of macro- and micronutrients; although, the nutrients are not balanced relative to crop requirements.
- Manure contains nutrients in organic and inorganic (crop available) forms. The organic form functions as a slow release fertilizer, gradually releasing nutrients to the crop. However, the uncertain timing of nutrient release relative to crop demand and the nutrient carryover to subsequent years can complicate soil fertility management.

Manure and Fertilizer as Potential Environmental Contaminants

Manure or fertilizer can boost soil fertility for crop production; however, both can also pose a potential environmental risk. Improper handling, storage and application of manure or fertilizer create a risk of contamination to soil, water, and air quality.

Risks to Soil Quality

Improper manure and fertilizer management can adversely affect soil quality in the following ways:

- Livestock manure can be a rich source of soluble ions like sodium (Na^+) and potassium (K^+) because animals retain only a small amount of the salt they consume. Repeat applications of manure at rates

exceeding agronomic requirements can contribute to saline soil conditions. Long-term buildup of Na can also have a negative impact on soil structure by reducing soil particle aggregation.

- Frequent traveling by loaded application equipment on wet soils can lead to soil compaction. Soil particles are squeezed together by compaction, reducing pore spaces available for air and water storage. This can inhibit root growth and increase surface runoff.

Risks to Water Quality

When manure or fertilizer is improperly handled or applied at rates exceeding crop requirements, contaminants including nutrients and pathogens can enter surface water and groundwater.

» Groundwater

Groundwater is an important source of water for many rural Albertans. Manure and fertilizer application pose several risks to groundwater including contamination from N, P, and pathogens. Manure and nitrogen fertilizer applications raise soil nitrate (NO_3^-) levels. Nitrate can leach into groundwater because it is soluble and mobile in soils. High-risk groups (e.g., infants and pregnant women) who consume water high in NO_3^- (i.e., above 10 ppm N or 45 ppm NO_3^- -N) have a reduced ability to transport oxygen in their bloodstreams. This condition is referred to as methemoglobinemia (“blue baby syndrome”).

Most soils in Alberta have a strong ability to adsorb (bind) P, which limits its entry into groundwater. However, leaching can occur when the soil’s adsorption capacity is saturated with high levels of P. This can happen from over-application of manure, particularly on coarse textured soils in high-rainfall or irrigated areas.

Transmission of manure pathogens to groundwater is rare, but can occur on coarse textured soils with high

water tables. It can also happen when contaminated runoff enters groundwater through an improperly installed or poorly maintained well.



The Walkerton Tragedy

In 2000, seven people died and over 2300 became ill in the rural community of Walkerton, Ontario when the town's water supply was contaminated with *E. coli* and *Campylobacter*. These potent pathogens are often implicated in food and water-borne illness.

The contamination source was runoff from a recently manured field, which entered the water system through an improperly protected well. While the producer was not responsible for the tragedy, it underscores the importance of doing a thorough site assessment prior to manure application.

Source: Ontario Ministry of the Attorney General

» Surface Water

Agricultural runoff contaminated with nutrients and pathogens is the primary risk to surface water quality. Eutrophication is the enrichment of surface water bodies by nutrients, particularly N and P. Phosphorus is often the first limiting nutrient in surface water ecosystems. Excess P entering surface water from runoff or P contaminated groundwater can result in increased algae production. Large algae blooms can significantly deplete oxygen levels when they die and decompose. Oxygen depletion will negatively affect aquatic animals. Blooms of blue-green algae (cyanobacteria) can also release toxins that are harmful to aquatic life, livestock and wildlife if they ingest the water. Eutrophication is a natural occurrence that is accelerated by human activities.

Transmission of manure pathogens to surface water is more likely than groundwater contamination. Surface water contamination by manure pathogens can occur on fine textured soils prone to erosion, or in situations where manure is applied or deposited too close to surface water bodies. For example, livestock that have direct access to water bodies can pose a significant risk to surface water quality.

Risks to Air Quality

Manure and fertilizer application can also adversely affect air quality. For example, ammonium (NH_4^+) in manure or fertilizer converted to ammonia (NH_3) gas can be lost to the atmosphere. This is a particular concern with unincorporated surface applications of manure or urea (46-0-0). Ammonia losses are reduced with subsurface applications and when surface applied products are thoroughly incorporated.

Odour emissions are a risk when surface applied products are not incorporated.

sidebar

High NO_3^- levels in drinking water can also affect livestock productivity.



sidebar

N losses via agricultural runoff are generally minor in comparison to P losses.

→ summary

- Fertilizer has several advantages over manure including: standardized nutrient content, readily plant available nutrients, can be blended to meet crop requirements, higher nutrient concentration and more easily handled.
- The advantages of manure relative to fertilizer include: minimal cost, provides a **broad nutrient profile, provides nutrients both immediately and slowly over time, and has soil conditioning benefits.**
- The major risks to soil quality from manure application are increased salinity and soil compaction due to use of application equipment during high-risk periods (e.g., wet spring season).
- The major risk to groundwater quality from nutrient application is NO_3^- leaching to groundwater sources, this has potential human and animal health concerns.
- The major risk to surface water is increased eutrophication resulting from nutrients carried to surface water bodies from **manured or fertilized fields.**
- Manure pathogens transmitted to surface water can pose a **significant risk to human and animal health** if consumed.
- Odour from manure application can adversely impact air quality, particularly with surface application without incorporation.

Chapter 3.1

Field Assessment

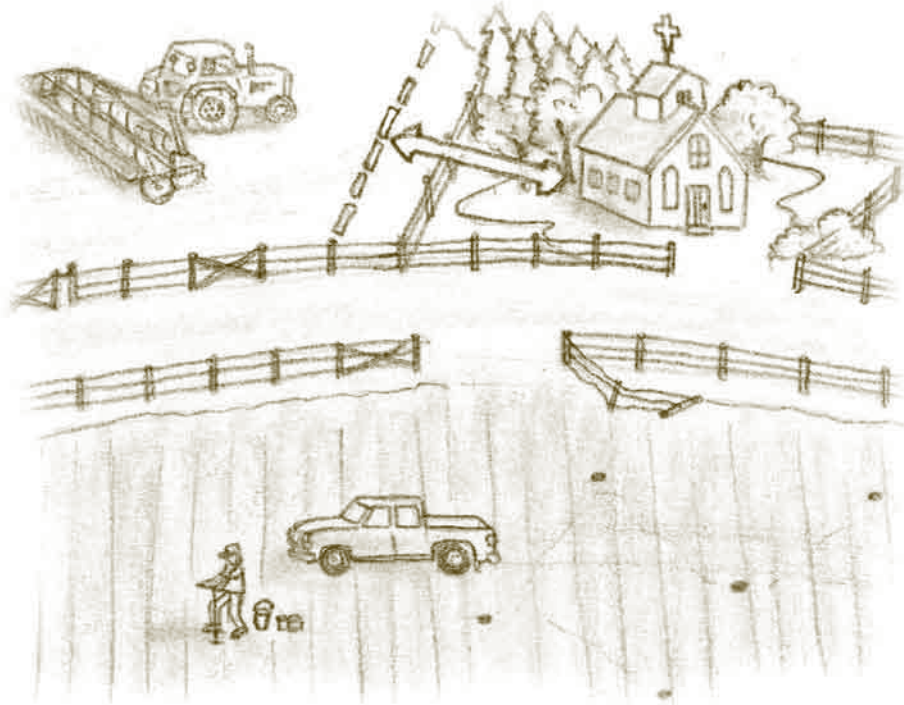

➔ learning objectives

- Identify five characteristics of site management to document during site evaluation.
- Describe key principles and methods for estimating the grade and length of slopes on a site.
- List two reasons why water bodies are important in nutrient management planning.
- Provide five examples of problem soil conditions to document during a site assessment.
- Identify and decide if additional physical features impact nutrient management planning.



Important Terms

Table 3.1.1 Key Terms and Definitions

Term	Definition
Bulk Density, Soil	The mass of dry soil per unit bulk volume. Bulk volume is determined before the soil is dried to constant mass.
Deep Ripping	A tillage process aimed at amending/shattering sub-surface compacted soil layers typically at depths greater than 30 cm.
Discharge Site	The area of the field over which groundwater and its associated salts emerge at the soil surface.
Montmorillonite Clay	Dominant 'type' of clay in Alberta soils. Characterized by swelling and shrinkage when wetted and dried.
Recharge Site	The area of the field over which water is absorbed and added to the zone of saturation.
Runoff	The portion of the total precipitation or surface water that does not enter the soil, rather it flows overland.
Water Holding Capacity	The ability of the soil to hold water. The water-holding capacity of sand is considered low, while that of clay is considered high.

The first step in nutrient management planning is to gather information about site characteristics and how they impact nutrient management. Sloping land, problem soils and the presence of water bodies all influence the fate of applied nutrients and must be considered in NMP's.

Five characteristics to identify during a site assessment are:

- Soil physical properties
- Slope
- Water bodies
- Problematic soil conditions
- Past and current site management

Soil Physical Properties

Soil physical properties include texture and structure. Understanding how these properties influence runoff and leaching potential, erosion susceptibility, nutrient retention, crop establishment and growth and the risk of compaction and crusting will enable more site-specific nutrient management decisions.

Soil Texture

Soil consists of four basic components: organic matter, minerals, air and water (Figure 3.1.1). The mineral component of soil is made up of sand, silt and clay particles (Figure 3.1.2). Soil texture is the percentage (by weight) of sand, silt and clay in the mineral fraction of a soil.

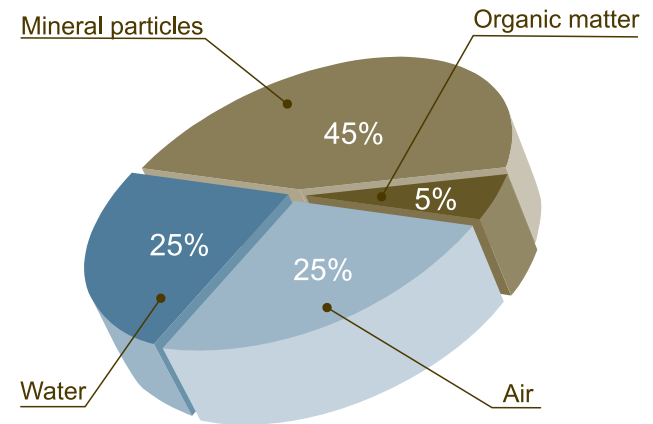
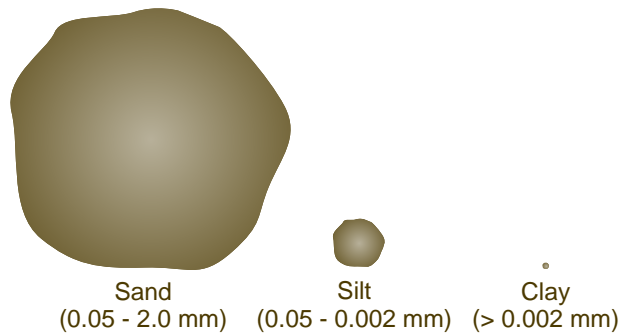

Figure 3.1.1 General Composition of Mineral Soils



Soil Particles	Diameter (mm)
Very coarse sand	2.0 - 1.0
Coarse sand	1.0 - 0.5
Medium sand	0.50 - 0.25
Fine sand	0.25 - 0.10
Very fine sand	0.10 - 0.05
Silt	0.05 - 0.002
Clay	< 0.002
Fine clay	< .00002

Based on Canadian Soil Classification Group, 1998

Figure 3.1.2 Relative Size of Different Types of Particles

Sand-sized particles can be seen with the naked eye or felt as grit when rubbed between the fingers. Sand has large and uneven surfaces that limit contact between adjacent particles. Consequently, soils dominated by sand do not form stable aggregates. Rather, these fragile aggregates are easily disrupted, suffer from poor structure, and are prone to wind erosion. The large pores formed between sand particles allow rapid water infiltration, but reduce overall water holding capacity.

Silt-sized particles cannot be seen with the naked eye, or felt when rubbed between the fingers. Silt particles cling together better than sand; however, silt contributes

little to the formation of stable aggregates in soil. The pores formed between silt particles are smaller than those formed by sand, which results in slower water infiltration and higher water holding capacity.

Clay-sized particles are only visible through electron microscopy. Clay's adhesive properties contribute to the formation of stable soil aggregates that are more resistant to physical disturbance (e.g., cultivation). Pore spaces between clay particles are even smaller than in silt, but the total pore volume is considerably larger. This slows water infiltration but significantly increases water-holding capacity. Clay has a huge surface area to volume ratio relative to larger sand and silt particles (Figure 3.1.3). Soils dominated by clay are prone to swelling when wet and cracking when dry.

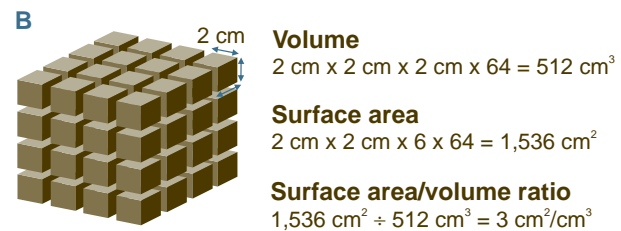
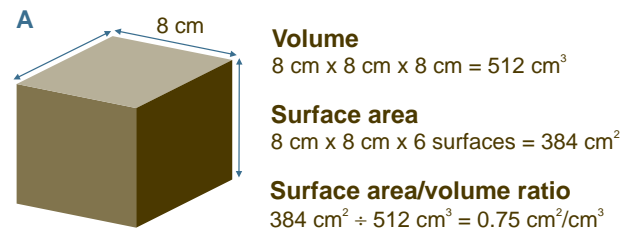

Adapted from Brady and Weil, 2000

Figure 3.1.3 Relationship Between Surface Area and Volume

s i d e b a r

A soil aggregate is formed when soil particles adhere to one another such that they behave as a single unit.



more info



Before applying manure to a field, AOPA requires a one-time laboratory test to determine soil texture. Details on AOPA soil testing requirements for nutrient management are discussed in Chapter 3.3.



Soil texture is determined in the laboratory through particle size analysis or manual texturing (Figure 3.1.5). Based on the proportions of mineral content in a soil, the soil textural triangle is used to determine a soil's textural class (Figure 3.1.4). For example, clay dominated soils are defined as fine textured, while sand dominated soils are coarse textured.

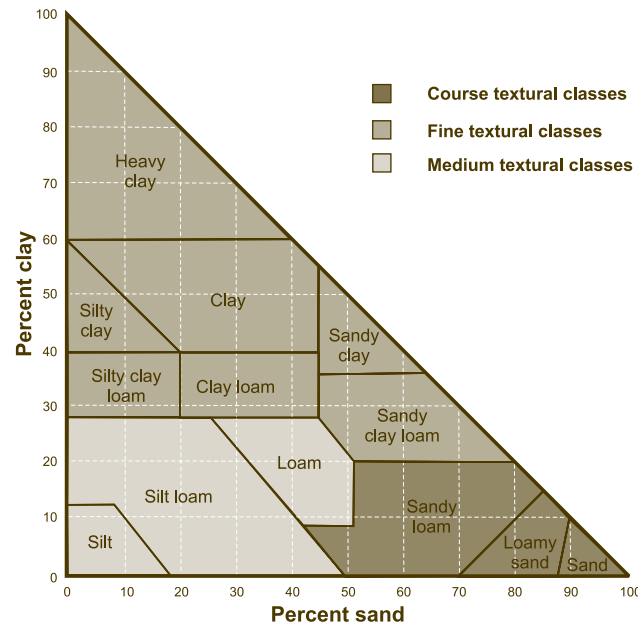

Adapted from Glossary of Soil Science Terms, 1976

Figure 3.1.4 The Soil Textural Triangle



Determining Soil Texture Using the Soil Textural Triangle

The particle size separation of three samples yielded the following percentages of sand and clay:

Sample	% Sand	% Clay
A	18	20
B	2	36
C	35	27

Based on Figure 3.1.4, sample A is a silt loam, B is a silty clay loam, and C is a loam.

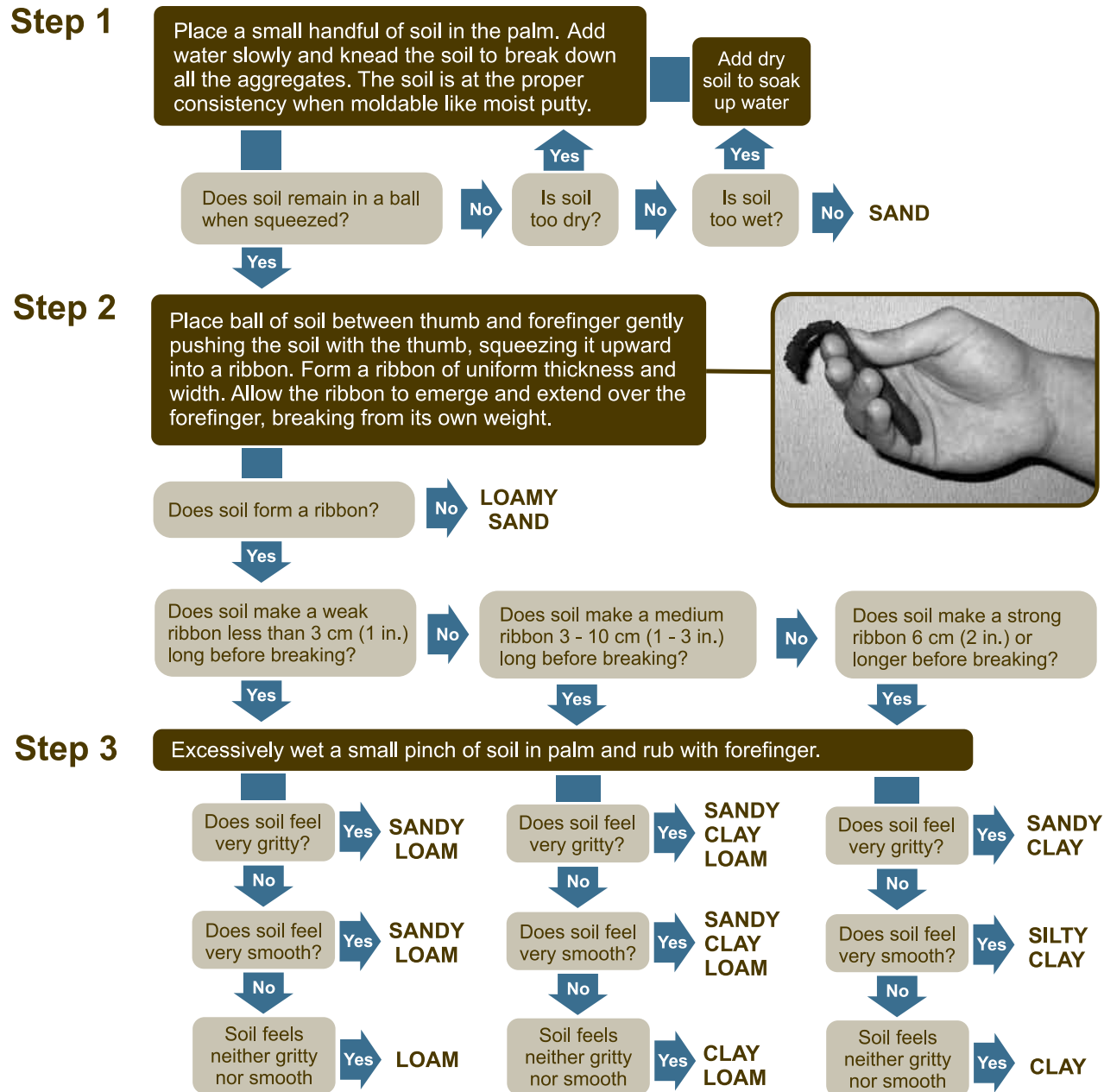

Adapted from McNeil et al., 1998a

Figure 3.1.5 Manual Method for Determining Soil Texture

side bar

The soils of western Canada are dominated by montmorillonite clays, which increase the CEC of the soil. Since cation exchange plays an important role in crop nutrition, soil texture then influences soil fertility.

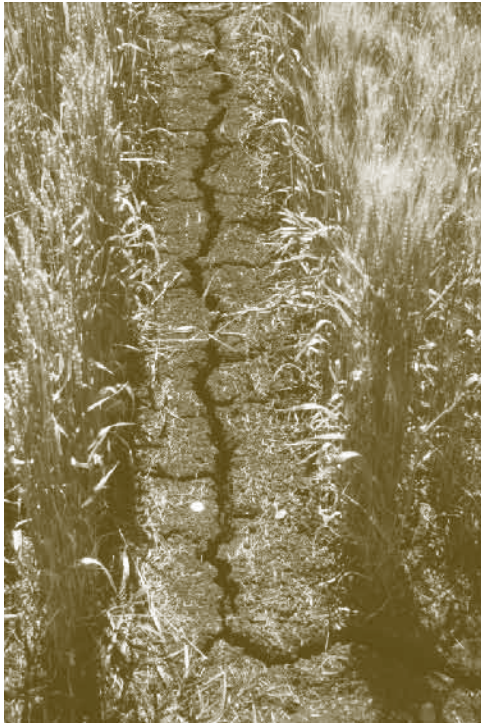

» Management Implications

Coarse textured soils have a higher risk for nutrient leaching into ground water because of higher infiltration rates and lower water holding capacity than medium or fine textured soils. This risk increases when groundwater is present at relatively shallow depths. Yield potential may also be lower on coarse-textured soils because of reduced water holding capacity and nutrient retention capacity. Excessive tillage should be avoided on coarse textured soils because of higher wind erosion risks.

Fine textured soils on sloping land adjacent to surface water bodies are at higher risk for runoff transport of nutrients to water bodies. These soils may have better yield potential due to higher nutrient and water holding capacities compared to medium or coarse textured soils. However, they are susceptible to compaction from field traffic when wet, reducing water infiltration and increasing runoff potential. These risks should be considered when planning and conducting field operations.

Soil Structure

Soil structure describes how individual soil particles clump together or aggregate. It is the result of several factors including: soil texture, root growth, decomposition, soil organic matter, freeze-thaw processes and soil micro and macro-organism activity. These physical and biological forces fracture clods, bind particles together and create channels for water movement and root growth. Cultivation tends to break down soil aggregates and destroy soil structure.

Soil structure is best determined by visual assessment. The Canadian System of Soil Classification (1998) describes four basic types of soil structure: structureless, block-like, plate-like and prism-like (Figure 3.1.6).

Type	Kind
<p>Structureless: No observable aggregation or clear orderly arrangement around natural lines of weakness.</p>	<p>Single grain structure: Loose mass of individual particles. Commonly found in sandy soils.</p>   <p>Massive structure: Soil appears in large clods with no visible structure.</p>  
<p>Block-like: Soil particles are arranged around a point and bounded by flat or rounded surfaces.</p>	<p>Blocky (angular blocky): Faces are rectangular and flattened. Faces intersect at relatively sharp angles.</p>   <p>Sub-angular blocky: Faces are a mixture of rounded and flattened. The edges are mostly rounded.</p>   <p>Granular structure: Sphere-shaped and characterized by rounded edges.</p>  
<p>Plate-like: Soil particles are arranged on a horizontal plane bounded by flat surfaces.</p>	<p>Platy structure: Flat plates of soil that lie horizontally.</p>  



Prism-like:

Soil particles are arranged on a vertical axis bounded by flat vertical surfaces.

Prismatic structure:

Well-defined vertical columns of soil with sharp edges.

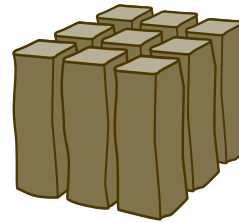

Columnar structure:

Vertical columns of soil with rounded edges, and are flat-topped, round-topped, or irregular.

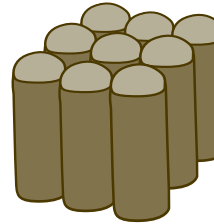

Sources: Canadian Soil Classification Group, 1998; Brady and Weil, 2000
Photos courtesy National Aeronautical and Space Administration (NASA)

Figure 3.1.6 Types, Kinds, and Classes of Soil Structure

» **Implications of Soil Structure for Nutrient Management**

Poorly structured (e.g., structureless or platy) soils have physical properties that may limit crop production, increase runoff and increase the risk of water erosion. In contrast, well-structured (e.g., granular) soils with stable aggregates promote better root development, enhance nutrient uptake and improve productivity. These factors must be considered when identifying field management strategies.

Identifying both surface and subsurface soil characteristics is important for managing nutrient leaching and runoff risk. Fields may have soil layers of

varying thickness with unique texture and structure. This can have a big impact on water infiltration rate (Figure 3.1.7). Soils prone to rapid water infiltration pose a higher risk of nutrient leaching, while those with poor infiltration have a higher risk of nutrient transport through runoff. Fields may be at risk of both if they have a layer of fine textured over coarse textured soil. This could result in runoff during rapid rainfall events and deeper nutrient leaching because of poor subsoil water holding capacity.

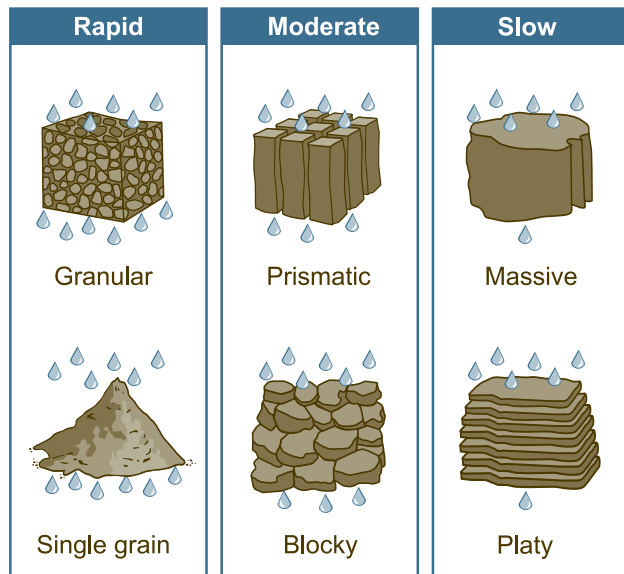

Adapted from Soil Conservation Service, 1991

Figure 3.1.7 Relative Rate of Water Infiltration of Various Soil Structures

Practices that enhance or promote good soil structure include:

- applying manure to the land
- including perennial forage crops in rotation
- returning crop residues to the land
- direct seeding or carefully managing tillage operations
- applying calcium-based amendments
- deep ripping of soils with subsoil hardpans
- avoiding field traffic during wet soil conditions

Slope

Sloped land presents a natural risk of runoff and erosion. Erosion from slopes adjacent to water bodies can increase nutrient transport to surface water. The grade and length of slope influences the potential of such risks.

Slope Grade

Slope grade is a ratio of the change in elevation over a given horizontal distance (Figure 3.1.8). In many fields slopes are not uniform, but instead have dips and bumps along their length. For practical purposes, nutrient management planning is concerned with the average grade of a slope.

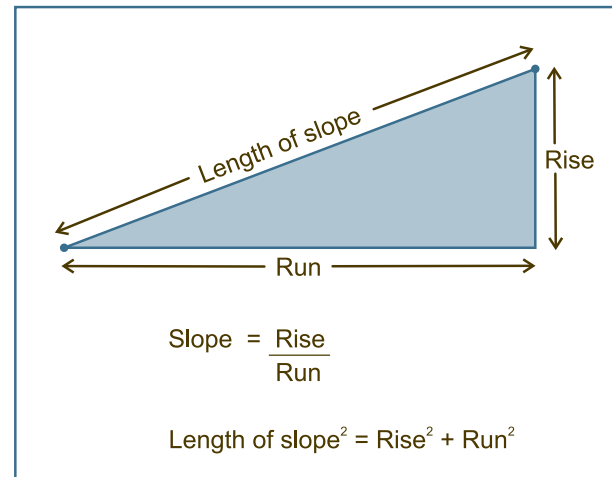

Figure 3.1.8 Measurement of Slope

more info



The grade of slopes adjacent to water bodies influences the required setback distance for certain manure application conditions under AOPA (Chapter 4.4).



sidebar

Soil sampling strategies (discussed in Chapter 3.3) are also influenced by the general topography and presence of slopes in a field.

tip



To get an accurate slope reading, pick a reference target that is clearly visible at eye height. The line of sight should run as close to parallel with the slope grade as possible. The reference target can be anything from a post, a vehicle or another person.

tip



Several post secondary training institutions offer short courses on the use of Global Positioning System (GPS) technology for agricultural and land management applications. Contact your local institution to find out about upcoming learning opportunities.



Calculating Grade and Length of Slope

Using a GPS unit, it is determined that a slope in one particular field has a run of 47 m and a rise of 6 m. The grade on this slope would be:

$$\begin{aligned}\text{Slope grade} &= \text{rise} \div \text{run} \times 100 \\ &= 6 \text{ m} \div 47 \text{ m} \times 100 \\ &= 12.8\%\end{aligned}$$

$$\begin{aligned}\text{Slope length} &= \sqrt{(\text{rise})^2 + (\text{run})^2} \\ &= \sqrt{(6 \text{ m})^2 + (47 \text{ m})^2} \\ &= \sqrt{36 \text{ m}^2 + 2209 \text{ m}^2} \\ &= \sqrt{2245 \text{ m}^2} \\ &= 47.4 \text{ m}\end{aligned}$$

The approximate grade of this slope is 13% and the length is 47 m.

There are several practical methods to determine slope grade including visual approximation, using a clinometer, and using a GPS. Choosing a method will depend on availability of technology and the level of precision required.

» Visual Approximation

The least precise, but simplest method for approximating slope is visual evaluation. Visual evaluation is useful for determining whether slope exceeds certain critical threshold grades (e.g., slope greater or less than 4%). This method is used in the Alberta Environmental Farm Plan field assessment process.

» Clinometers

A relatively precise, yet simple method for estimating slope is using a clinometer (Figure 3.1.9). This tool measures the angle or percent (or both) grade of a slope.



Photo courtesy National Resource Conservation Service

Figure 3.1.9 Slope Grade Measurement Using a Clinometer

Clinometers range in price from \$20 to more than \$300, depending on the sophistication of the instrument. Designs for simple, inexpensive homemade clinometers can be found online.

» GPS

A GPS unit can be used in the field to determine slope (Figure 3.1.10). Most GPS units provide relatively accurate coordinates that can be used to calculate the grade and length of slope (see equations in Figure 3.1.8).

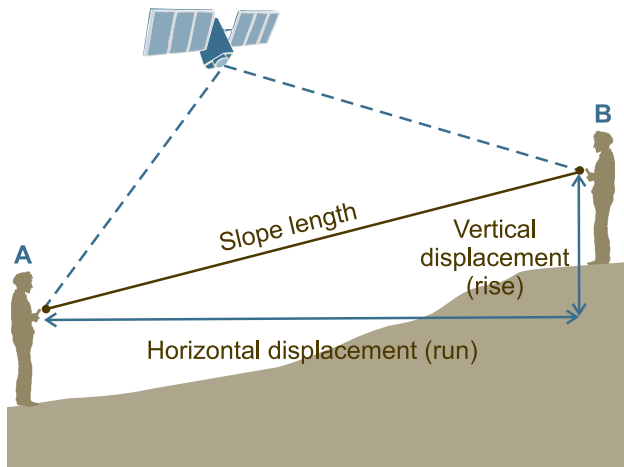

Figure 3.1.10 Using GPS Technology to Determine Length of Slope

Slope Length

Unlike grade, there are no regulations on slope length so there is less need for a precise measurement. There are a number of simple ways to estimate slope length including:

- Estimate the length of the slope in relation to a known distance.
- Pace out short slopes. If stride-length is known and consistent, pacing will provide a reasonable estimate of distance covered. Keep in mind that sloping land will affect a normal stride.
- Use a vehicle's odometer. This strategy should not be used on sites with steep slopes where there is a risk of rollover.

Slope Length in Relation to a Known Distance

A quarter section of land is approximately 800 m by 800 m (half a mile by half a mile). Based on an in-field assessment and aerial photos, a slope travels at least half the length of a quarter section. Therefore, the length on this slope would be at least 400 m.



Pacing out Slope Length

A landowner travels 10 paces up a slope at a distance of 8.8 m. It takes him 122 paces to travel the entire slope from base to crest. The estimated length of the slope is:

$$\begin{aligned} \text{Slope length} &= \text{average distance travelled per pace} \times \\ &\text{length of slope (in paces)} \\ &= 8.8 \text{ m} \div 10 \text{ paces} \times 122 \text{ paces} \\ &= 0.88 \text{ m per pace} \times 122 \text{ paces} \\ &= 107.4 \text{ m is the estimated length of this slope} \end{aligned}$$

» Management Implications

The grade and length of slope are natural risk factors for soil erosion due to runoff. Topography also influences the pattern of surface water flow.

In general, runoff and erosion risks increase as slope grade increases. Erosion redistributes nutrients (dissolved and sediment-bound) and organic matter within the landscape. Erosion from slopes adjacent to water bodies can increase nutrient transport to surface water. Choosing appropriate land management practices to mitigate erosion depends on whether runoff flow is concentrated or more generalized (e.g., grassed waterway versus vegetative filter strip).

more info



See template for a simple homemade clinometer (along with instructions for use) in Appendix 3.

sidebar

The salt tolerance of various crops grown in Alberta is presented in Table 3.4.5 (Chapter 3.4).



sidebar

The generalized pH classification of soils is discussed in Chapter 3.4.

Redistribution of nutrients and surface water flow patterns due to topography will influence productivity, creating areas of higher and lower productivity within a field. This presents an opportunity to use landscape specific management strategies such as management zoning and variable rate nutrient application. These strategies offer the potential for controlled nutrient placement to optimize utilization, minimize accumulation, and decrease the risk of loss.

Water Bodies

The location of water bodies, in or adjacent to fields that receive nutrient application, is a critical feature to identify during a site assessment. Water bodies include, but are not limited to:

- active or abandoned wells
- springs
- sloughs
- lakes
- rivers
- streams
- aquifers
- wetlands

» Management Implications

Whenever nutrients are applied near a water body there is a potential risk to water quality. According to AOPA, manure application setbacks apply only to “common bodies of water”—i.e., water bodies that are not entirely contained on land controlled by a landowner. However, for good environmental stewardship it is important to protect all water bodies.

Problem Soil Conditions

Problem soil conditions can limit the productive potential of a site. Some common conditions that should be identified include:

- Salt-affected soils
- Soil pH
- Solonetzic soils
- Organic soils
- Eroded soils

Salt-Affected Soils

Saline soils have high concentrations of soluble salts in surface soil layers. These soils are identified through a combination of soil testing and visual inspection of a site.

» Management Implications

Soil salinity can limit crop yield by impairing a crop’s ability to efficiently use soil moisture. Crops vary in their sensitivity to saline conditions. Salt-sensitive crops have less yield potential and lower nutrient requirements than more salt-tolerant crops. It may be advantageous to include more salt-tolerant perennial species such as tall and slender wheatgrass in rotations. Six-row barley is the most tolerant annual crop followed by two-row barley, canola and wheat. Depending on the cause of the salinity issue, specific management to address recharge and discharge sites within the field may be required.

Soil pH

In Alberta, acid soils occur frequently in the central Peace River regions (Figure 3.1.11). Alkaline soils are more common in the Brown and Dark Brown soil zones and on eroded hilltops.

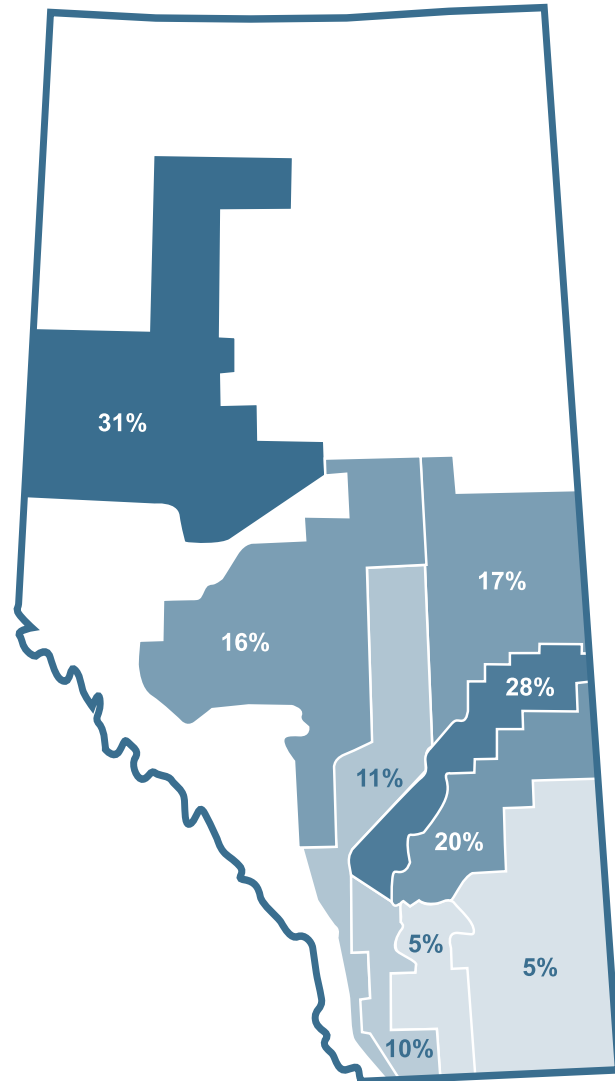

Adapted from Kryzanowski, 1996

Figure 3.1.11 Occurrence of Acid Soils in Alberta

Since pH can vary considerably within individual fields, regional generalizations about soil pH conditions are not adequate for site-specific nutrient management. As such, field specific determination of pH is important. If pH is identified as a problem, a detailed sampling strategy can be used to determine the extent and severity of pH problems within the field.

» Management Implications

Soil pH should be considered when making management decisions for a number of reasons:

- Extreme pH conditions will limit crop growth unless tolerant crops are selected. Most crops prefer pH in the neutral range (pH 6.5 to 7.0).
- Acidic conditions reduce the rate of organic matter decomposition, which affects the rate of nutrient release from organic sources.
- Alkaline or acidic soil conditions can reduce nutrient availability (see Figure 2.2.4, Chapter 2.2). Nutrient management planning should factor in reduced crop yield potential and nutrient availability on acid or alkaline soils.
- Soil pH reduces the rate of breakdown of some herbicide residues. This could result in herbicide injury to sensitive crops following in rotation. Therefore, when planning crop rotations consider possible herbicide carry over.
- At elevated soil pH (greater than 7.5), the natural equilibrium between ammonium (NH_4^+) and ammonia (NH_3) shifts in favor of NH_3 , which can be lost by volatilization. Therefore, incorporation of broadcast manure and fertilizer is critical on high pH soils to minimize NH_3 losses.
- Nodulation of many legume crops is impaired in low pH soils. This reduces the amount of N fixed by the crop and increases the need for supplemental N inputs.

more info



For more information on managing acid soils, check out these factsheets, which can be ordered from the AF Publications Office or searched by Agdex number on Ropin' the Web:

- 1996. Liming acid soils. Agdex 534-1.
- 2002. Wood ash: An alternative liming material for agricultural soils. Agdex 534-2.



more info



For more detailed information on salinity types and practical management check out these publications, which can be ordered from the AF Publications Office or searched by Agdex number on Ropin' the Web:

- 1997. Perennial crops for recharge control of saline seeps. **Agdex 518-13.**
- 1997. Annual crops for recharge control of saline seeps. **Agdex 518-14.**
- 1997. Perennial crops for salinity control in discharge areas. **Agdex 518-15.**
- 1998. Structural controls for dryland saline seeps. **Agdex 518-16.**
- 2000. Dryland saline seeps: types and causes. **Agdex 518-12.**
- 2001. Salt tolerance of plants. **Agdex 518-17.**

Solonetzic Soils

Solonetzic soils are found primarily in eastern Alberta, between Vermilion and Brooks. Solonetzic soils are naturally high in exchangeable sodium, characterized by the presence of a tough, impermeable hardpan layer found 5 to 30 cm or more below the surface (Figure 3.1.12).



Hardpan

Figure 3.1.12 Profile of a Solonetzic Soil

» Management Implications

Solonetzic soils severely restrict root penetration and water infiltration, resulting in poor crop growth and reduced tolerance to drought or flood conditions.

Solonetzic soils exhibit in-field variation in topsoil depth, pH, fertility and subsoil characteristics.

Variation in topsoil depth above the hardpan layer is largely responsible for the wavy pattern of crop growth observed on solonetzic soils (Figure 3.1.13). These soils have natural productivity constraints, which should be considered when making nutrient management decisions. Some management practices can improve the productivity of solonetzic soils (e.g., subsoil cultivation or deep ripping), however, these are not applicable to all situations.

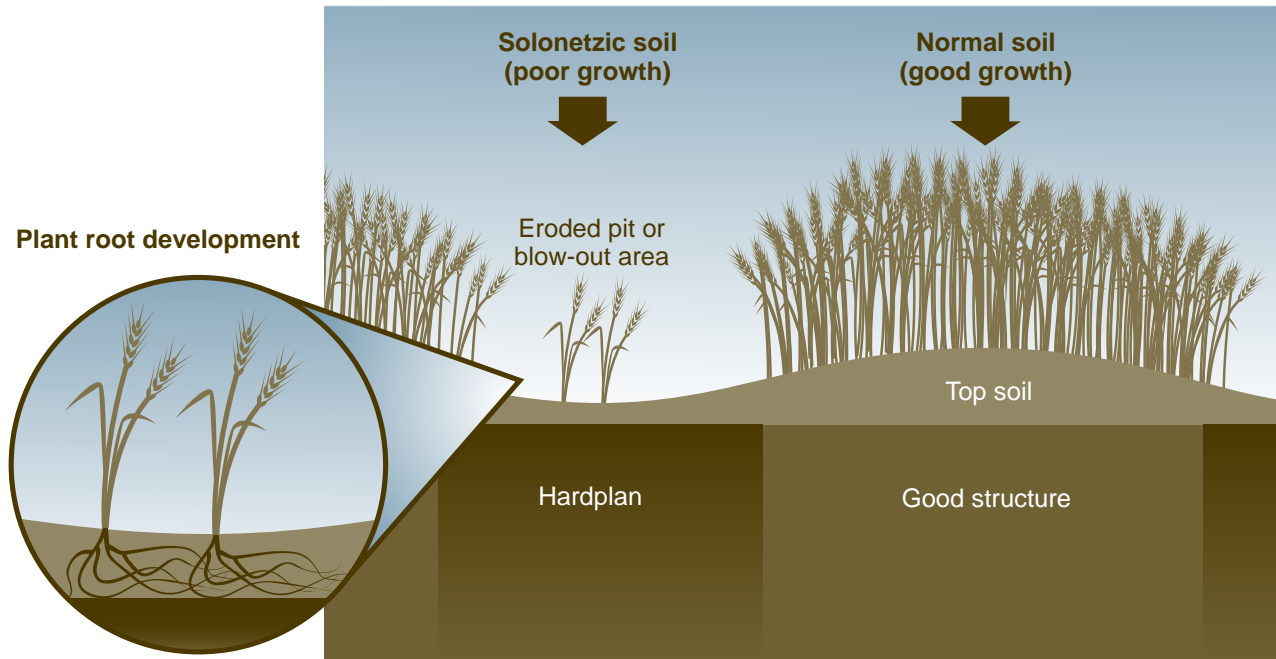

Figure 3.1.13 Wavy Growth Pattern Often Seen in Fields with Solonetzic Soils

Adapted from AAFRD, 1985c

Organic Soils

Organic soils, sometimes referred to as peat or muskeg soils, occur primarily in the Gray Luvisolic soil zone of Alberta. Individual peat bogs may vary in size from a few to thousands of hectares.

Organic soils form in low-lying areas that are flooded for part of the year. These soils form because excess soil moisture, coupled with cool climatic conditions, cause slow rates of plant residue decomposition. The result is a

net accumulation of organic matter, creating an organic layer a few centimetres to several metres thick.

Organic soils are classified as sedge peats or moss peats, depending on the primary vegetation. In general, sedge peats are more suited to agricultural development because they have more favourable water holding capacity and fertility than moss peat. (Table 3.1.2).

more info



For more information on practical management of solonetzic soils, check out this factsheet, which can be ordered from the **AF Publications Office** or accessed on **Ropin' the Web**:

- 1993. Management of solonetzic soils. Agdex 518-8.



more info



More information on practical management of erosion and eroded

soils, check out these factsheets, which can be ordered from the **AF Publications Office** or searched by **Agdex number on Ropin' the Web:**

- **AF. 1997. An introduction to water erosion control. Alberta Agdex 572-3.**
- **AF. 1998. Emergency wind erosion control measures. Agdex 572-1.**
- **AF. 1998. An introduction to wind erosion control. Agdex 572-2.**
- **AF. 2002. Fertilizing eroded knolls. Agdex 541-2.**



Table 3.1.2 Physical and Chemical Characteristics of Organic Soils

Organic Soil Type	Fibre Content	Moisture Holding Capacity (% of dry weight)	Electrical Conductivity (dS/m)	pH	Total N (% by weight)
Sedge Peat	Low	400-600	0.5 – 3.5	5.0 – 8.5	2.0 – 3.0
Moss Peat	Very high	1000-1500	0.2 – 0.4	3.5 – 5.5	0.5 – 1.0

Source: AAFRD, 1985e

» Management Implications

The natural characteristics of organic soils present some challenges to agricultural production and nutrient management. Organic soils are often waterlogged during certain times of the year (e.g., spring) because they are associated with high water tables. As a result of these characteristics, organic soils experience greater nutrient losses through leaching and denitrification, and impeded crop establishment and early growth.

Organic soils are very high in organic matter; therefore, the carbon to nitrogen (C:N) ratio is large. This slows the release of N from organic matter to the point where N available for plant uptake can be limited. Organic soils are also prone to micronutrient deficiencies, particularly copper, which may reduce productivity.

If a field has small areas of organic soil and the organic layer is thin enough, it may be feasible to incorporate and mix it with the mineral layers below. This action will improve the balance of organic and mineral fractions in the surface soil layer and potentially increase the rate of decomposition. This action will not, however, affect the water table or the risk of waterlogging. If large areas of organic soil dominate a field, the cropping options are typically limited to more flood tolerant forages, such as Garrison creeping foxtail, reed canary grass and timothy.

Eroded Soils

Eroded soils are unproductive areas that form largely as a result of erosion or excessive cultivation. Topsoil is stripped from the surface exposing the dense, compact, low organic matter subsoil. Productivity on these areas may be low due to poor fertility and restrictive soil physical properties. Exposed subsoils will have little or no soil development and usually have elevated pH. Eroded areas are also susceptible to drought conditions due to their poor water holding capacity and limited permeability.

» Management Implications

Eroded soils have several problems that limit yield potential such as crusting, restricted root growth, limited water availability, low fertility and pH extremes (high or low).

The hard, compact nature of exposed subsoils can negatively impact yield potential by restricting root growth and surface crusting. Emerging plants have a difficult time pushing through the surface crust to access light and extending roots through the soil to reach nutrients. The compact nature also increases the bulk density of the soil, making it difficult for water to infiltrate and reduces water availability for crop growth.

The loss of nutrient-rich organic matter from eroded soils greatly reduces soil productivity. The addition of fertilizer and manure can enhance the productivity of these areas by adding nutrients and organic matter. Landscape-specific management strategies, such as variable rate technology and targeted manure application, can be used to improve productivity and soil quality in these areas.

Eroded soils typically have pH issues. Extremes in pH can affect the availability and risk of loss of some nutrients. For example, alkaline soil conditions reduce the availability of phosphorus, and promote higher losses of nitrogen (N) in the form of ammonia from fertilizer or manure.

Strategies for reclaiming eroded areas and improving soil structure include: the addition of manure, returning or maintaining crop residues, direct seeding, or the establishment of perennial forages. These areas should also be managed using erosion control measures to prevent further degradation.

Past and Current Site Management

Evaluating past and current management practices will help in identifying necessary changes to reduce environmental risk or improve site productivity.

Key Information on Site Management

- **Improved drainage:** The presence of tile drainage or ditching significantly increases the risk of nutrient loss or movement from a field.
- **Recent fertilizer application history:** Document application history including type, application rate, timing of application (e.g., fall versus spring) and method and timing of incorporation.
- **Manure application history:** Document manure source (e.g., beef, hog, etc.), manure

test information, application rate, timing of application (e.g., fall versus spring) and method and timing of incorporation. Account for residual nutrient availability when planning future nutrient applications, particularly if manure has been applied on the site within the last two years.

- **Tillage practices:** Fields under direct seeding or other reduced tillage systems have less risk of nutrient runoff losses. However, the incorporation of manure, particularly solid manure, on these sites may not be practical. Without adequate incorporation, volatile N losses from the manure could be substantial.
- **Crop rotation:** Short or long-term cropping plans for a site can reveal opportunities for reducing the risk of nutrient loss, building soil organic matter and determining expected nutrient removal by future crops. Account for anticipated nutrient release from past green manure crops in the rotation.
- **Issues relating to row crops:** Row crop management increases the risk of runoff, erosion and soil compaction.
- **Presence of irrigation:** Fields under irrigation management have higher yield potential and can support a greater variety of crops, but are also at increased risk for nutrient leaching and runoff. Be aware of potential soil quality implications and the addition of nutrients present in irrigation water.
- **Past soil test information:** Historical soil test results can help identify chronic soil problems (e.g., salinity, acidity) that may affect crop selection.
- **Existing control structures or beneficial management practices:** In some situations, structures or practices may already be in place to minimize erosion and nutrient loss. Evaluate these to identify any necessary improvements. In some cases, effective practices or structures may allow for manure applications that otherwise would have been restricted under AOPA.





Other Features of Interest

During the site assessment, document any other site features that might affect crop productivity. These features may impact the ability to apply nutrients or crop protection products, or these features may affect the environmental risk associated with producing a crop on that site. Identifying additional site features is particularly important if custom applicators are unfamiliar with the site. Awareness of these features provides the applicator with an understanding of the risks and liabilities associated with the site.

Some examples of additional features to identify include:

- drainage pattern or structures (e.g., tile drainage systems)
- public roads or ditches that run adjacent to the site
- irrigation structures
- wildlife habitat
- presence of endangered species on the site (including endangered plant species)
- rock outcroppings
- oil well sites and road allowances
- proximity to neighbours (if there is a risk of nuisance arising from field operations)
- presence of damage from burrowing animals (e.g., pocket gophers, ground squirrels, badgers, etc.)
- areas of compacted soil or soils with drainage issues
- woodlots
- above-ground or buried utilities

To determine whether a feature should be included in the site assessment portion of the nutrient management plan, consider the following questions:

Questions to Determine Relevance of a Feature

1. Will the feature affect the rate, timing, or pattern of manure or fertilizer application?
2. Does the feature increase the environmental risk associated with producing a crop on the site under the proposed management system?
3. Will this feature contribute to nuisance issues resulting from field operations involved in producing a crop on the site?
4. Will it be necessary to implement a management practice to offset the impact of the feature?
5. Does the feature present a potential hazard or obstacle to any equipment that will be used in the production of a crop on the site?

If the answer is “yes” to any of the above questions, document and incorporate the feature into the planning and decision-making process.

➔ summary

- **The five features of site management** to document are: soil physical properties (texture and structure), slope, water bodies, problematic soil conditions and site management practices.
- Slope grade is the relationship between rise and run, and can be determined using clinometer or GPS technology.
- Slope length can be determined by visual estimation, pacing the distance or vehicle odometer.
- **Water bodies need to be identified because** of potential adverse effects of nutrients on water quality and legislated setback distances under AOPA.
- Problematic soil conditions that affect productivity include: salinity, extremes in soil pH, solonetzic soils, organic soils and eroded areas.
- Some additional physical features that **could be identified in a site assessment** includes: public roads or ditches, irrigation structures, wildlife habitat, rock outcroppings, proximity to neighbours, areas of compacted soil or soils with drainage issues.
- A feature should be included in a site assessment if it will affect the rate, timing or pattern of nutrient application; if it **increases the environmental risk of field operations**; if it requires in an alternative management practice; or if it is a potential **hazard or obstacle to field equipment**.

Chapter 3.2

Using Aerial Photos for Nutrient Management Planning

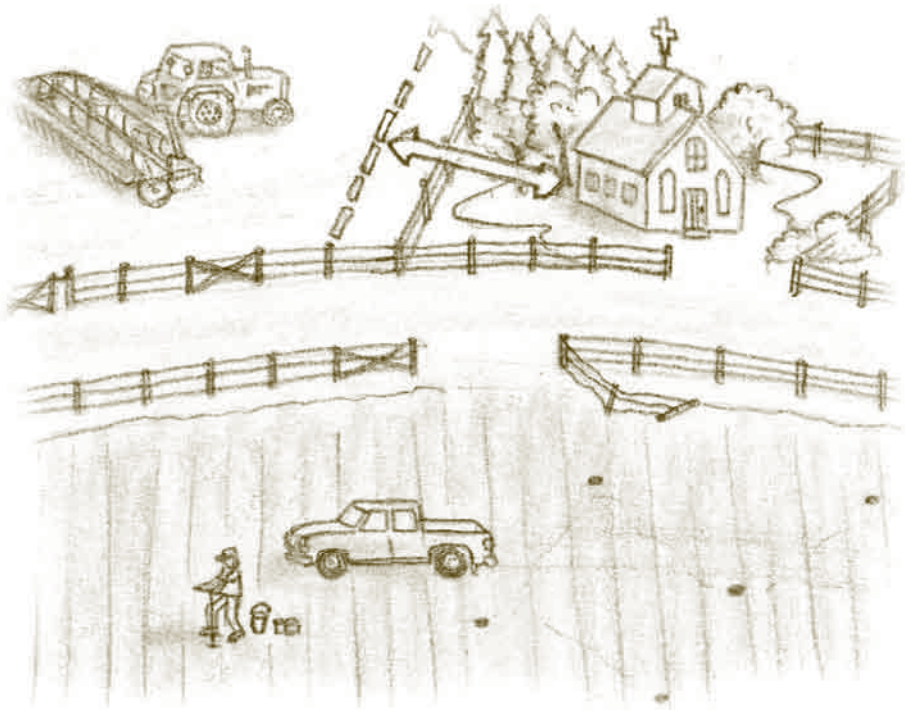

➔ learning objectives

- Use aerial photos to identify major permanent features in a field.
- Estimate distances and land areas on aerial photos of known scale.
- Order air photo products from the Provincial Government's Air Photo Distribution Office.

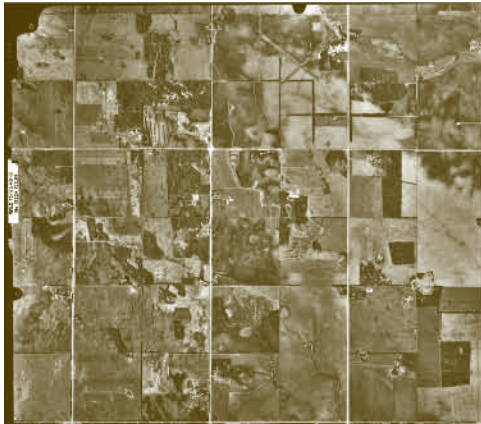

Important Terms

Table 3.2.1 Key Terms and Definitions

Term	Definition
Spatial	Relating to, occupying, or having the character of space. Relating to the three dimensional positioning of an object in space.

An aerial photo shows spatial relationships between features in a field. Aerial photos can be used to estimate total available area for nutrient application, while considering application setbacks from sensitive areas. Interpreting aerial photos involves identifying features, assessing their significance, and determining their spatial relationship to other features in the field. An aerial photo provides a different perspective of the landscape than ground-based observation. An aerial perspective reveals the horizontal orientation of a feature in a landscape, but the trade-off is the inability to judge the height or elevation of a feature.

There are two important points to remember when using aerial images:

- Aerial photos complement, but should not replace, a ground-based site assessment. They provide a complete perspective of the relative location and orientation of features within a field.
- The usefulness of aerial photos depends on the user’s ability to interpret qualitative and quantitative information in the image.

Interpreting aerial photos involves considering the following aspects:

- **Scale** is the ratio of the distance between two points on an aerial photo to the actual distance between those two points on Earth’s surface (Table 3.2.2). For example, an aerial photo with a scale of 1:15,000, one unit of measurement (centimeters or inches) on the photo is equal to 15,000 of these same units on the ground.

- The relative **size** of known features can be used to estimate their relative “footprint” on the landscape as well as the approximate size of surrounding features.
- The **shape** of an object from an aerial view can help distinguish human-made features (e.g., buildings) from natural features (e.g., water bodies).
- The **shadows** cast by objects in a photo will depend on the time of day and year the photo was taken. This may affect the interpretation of the objects casting the shadow.
- **Tone** refers to the colour or shade of grey of objects in a photo, and the pattern in which these colours are reflected (uniform, mottled or banded). Tone is influenced by several factors including soil moisture, vegetation type and density, time of day and year the photo was taken (Table 3.2.3).
- **Texture** is the impression of “smoothness” or “roughness” of an image. Texture offers the ability to distinguish boundaries between individual objects in a photo. Objects that are too small to be distinguished from each other tend to appear “smooth” (e.g., grass, cement, water), while objects with more distinguishable boundaries appear “rough” (e.g., forest canopy).
- **Pattern** refers to the spatial arrangement of objects in an aerial photo. Patterns can be natural (e.g., forested area) or the result of human activities (e.g., cultivated woodlot).
- **Unknown objects** can be identified in an aerial photo by considering their location and association to known objects.

Table 3.2.2 Map Scales and Conversions

Map Scale	Map cm ↓ Actual m	Actual km ↓ Map cm	Map inches ↓ Actual feet/miles	Actual miles ↓ Map inches
1:10,000	× 100	× 10	× 833.33 (ft)	× 6.34
1:12,000	× 120	× 8.33	× 1,000 (ft)	× 5.28
1:15,000	× 150	× 6.67	× 1,250 (ft)	× 4.22
1:50,000	× 500	× 2	× 0.789 (mi)	× 1.27
1:100,000	× 1,000	× 1	× 1.58 (mi)	× 0.63

Adapted from McNeil et al., 1998b

Estimating Areas and Distances Using an Aerial Photo

Aerial photos can be used to estimate distances and areas with simple equipment and calculations. To aid in the calculation of distances and areas, nine of the commonly used or available air photo scales are listed in Table 3.2.4 and Table 3.2.5. For each of the common scales, table 3.2.4 reports the distance on the ground for each one cm measurement on the photo, the cm measurement for each km, the number of hectares per square cm and the number of hectares represented by each dot on an acreage grid map (64 dots per square inch). For each scale table 3.2.5 reports the distance on the ground for each one inch measurement on the photo, the measurement for each mile, the number of acres per square inch and the number of acres represented by each dot on an acreage grid map (64 dots per square inch).

An example of a partial acreage grid map is illustrated in Figure 3.2.1. A grid map will be made up of multiple rows and columns segmented into one inch by one inch squares. Each square contains 64 evenly spaced dots. The size of the grid map can vary depending on its application. The larger the photo, the larger the grid map may be. Appendix 3 contains a grid map that is seven columns wide by seven rows deep. This may be photocopied onto a transparency and used to determine areas on a photograph.

tip



Remember that distances and dimensions distort as you move from the centre of the image to the edge of the photo.

Table 3.2.3 Appearance of Selected Features on an Aerial Photograph (black and white, true colour, and false colour infrared aerial photographs)

Feature	Type of Aerial Photography		
	Black and White Panchromatic	True Colour	False Colour Infrared
Soils			
Dry	Light grey	Light grey	Light green-black
Wet	Dark grey-black	Dark grey-black	Dark green-black
Eroded	Similar in appearance to dry soils		
Sandy	Light grey-white	Light grey-white	Light grey-white
Vegetation			
Cereals	Mottled grey-black	Mottled green	Mottled pinkish-red
Cereals (harvested)	Mottled light grey/black	Mottled goldish	Mottled goldish pink-white
Forages/Hay	Uniform grey-black	Uniform green	Uniform red
Forages/Hay (harvested)	Uniform light grey-black	Uniform gold-pink	Uniform pinkish-white
Canola (bloom)	Uniform light grey	Uniform yellow	Uniform pink
Canola (harvested)	Similar in appearance to harvested cereals		
Grasses	Uniform grey	Green brown	Brown
Conifers	Conical shaped grey-black	Conical shaped green	Conical shaped purplish-brown
Deciduous	Fluffy grey	Fluffy green	Fluffy red
Deciduous (autumn)	Grey	Yellow	White
Natural features			
Hilly Topography (bare soil)	Mottled grey-black	Mottled grey-black	Mottled green-black depending on soil moisture
Eroded Knolls	Lighter versions of hilly topography		
Sloughs	Will appear dark if they are clear. If sediment is present near the surface, they will appear lighter as the sunlight is reflected back.		
Rivers/Streams	Winding shaped features that will reflect similar to water bodies.		
Organics	Uniform grey	Uniform green	Uniform pink-red
Salinity	Whitish	Whitish	Whitish
Cultural features			
Fields	Will appear as square or rectangular and reflect according to what has been planted (i.e., cereals, forages, etc.)		
Pasture	Mottled grey-black	Mottled green-black	Mottled pink-green
Gravel Road	Grey	Grey	Grey
Paved Road	Black	Black	White-grey

Source: AF

Table 3.2.4 Common Map Scales Plus Approximate Metric Measurements and Estimates of Area

Relative Scale	Scale in Centimetres and Meters	cm per km	ha per Grid Map Square (2.5 x 2.5 cm)	Representative ha for Each Dot in the Square
1:5,000	1 cm = 50 m	20.0 cm	1.613	0.0252
1:10,000	1 = 100	10.0	6.452	0.101
1:15,000	1 = 150	6.667	14.517	0.227
1:20,000	1 = 200	5.0	25.807	0.403
1:30,000	1 = 300	3.333	58.066	0.907
1:31,680	1 = 316.8	3.157	64.752	1.012
1:40,000	1 = 400	2.5	103.229	1.613
1:60,000	1 = 600	1.667	232.265	3.629
1:63,360	1 = 633.6	1.578	259.008	4.047

Table 3.2.5 Common map scales plus approximate imperial measurements and estimates of area

Relative Scale	Scale in Inches and Feet	Inches per Mile	ac per Grid Map Square (2.5 x 2.5 cm)	Representative ac for Each Dot in the Square
1:5,000	1 inch = 417 ft	12.672	3.986	0.0623
1:10,000	1 = 833	6.336	15.942	0.249
1:15,000	1 = 1,250	4.224	35.870	0.560
1:20,000	1 = 1,667	3.168	63.769	0.996
1:30,000	1 = 2,500	2.112	143.48	2.242
1:31,680	1 = 2,640	2.000	160.00	2.5
1:40,000	1 = 3,333	1.584	255.076	3.986
1:60,000	1 = 5,000	1.056	573.92	8.970
1:63,360	1 = 5,280	1.000	640.00	10.0

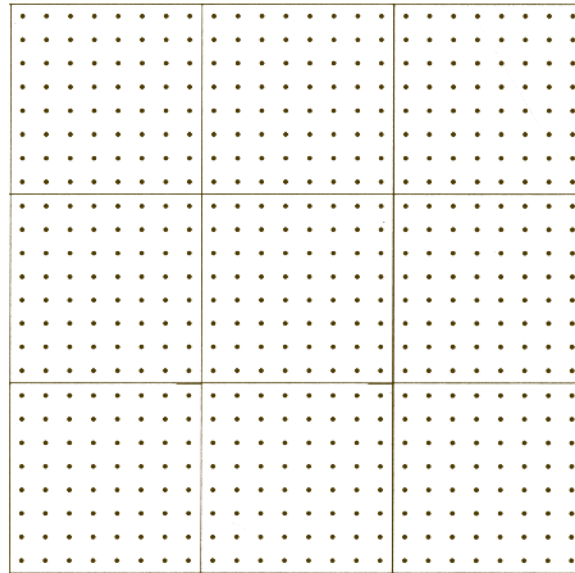

Figure 3.2.1 A partial acreage grid map

Calculating Distances

The scale of an aerial photo is the ratio of the distance between two objects on a photo to the actual distance on the surface of Earth, in the same units. For example, an aerial photo with a scale of 1:5,000, a 1 cm measurement on the photo is equal to 5,000 cm or 50 m on the actual ground. Distance can be calculated from the scale of a photo using the following equation:

$$\text{Distance on the Ground (units)} = \text{Measurement on Photo (units)} \times \text{Scale of Photo (e.g., 5,000)}$$

Calculating Distances from an Aerial Photo

AOPA does not allow surface application and incorporation of manure within 30 m of a common body of water.

A producer has a field that is bordered by a creek. Using an aerial photo, the producer wants to determine the width of the grassed strip between the edge of the field and the creek. He wants to determine if he can apply manure right to the edge of this field or if he needs to stay back from the grassed edge to meet the 30 m setback. On a 1:5,000 scale aerial photo, the distance between the edge of the field and the creek is 1.4 cm.

$$\begin{aligned} \text{Distance on the Ground (units)} &= \\ \text{Measurement on Photo (units)} \times \text{Scale of Photo} & \\ \text{(e.g., 5,000)} & \end{aligned}$$

$$= 1.4 \text{ cm} \times 5,000$$

$$= 7,000 \text{ cm}$$

$$= 70 \text{ m is the distance on the ground}$$

The edge of the field is 70 m from the creek. Therefore, the producer can apply manure to the field boundary, provided it is incorporated within 48 hours of application.

Estimating Areas

To estimate areas on aerial photos of known scale the following materials are needed:

- standardized grid that is printed or copied onto a transparency
- fine tipped, non-permanent pen (for use on transparencies)
- standard school geometry set
- calculator

By overlaying a transparent acreage grid map on an aerial photo you can estimate area, knowing the aerial photo's scale. The following is a list of steps to estimate areas from aerial photos:

1. Trace the outline of areas to be estimated on a photocopy of the aerial photo, a printed copy of a digital image or an unmarked transparency. This will make area boundaries easier to identify and will preserve the original photo.
2. Superimpose the standardized grid on the tracing of the aerial photo and trace directly on the grid the boundaries of all areas to be estimated.
3. Put the grid on a white background for easier viewing. Count and record the grid dots contained in each outlined area. For dots that lie on the boundary line, count every other one.
4. Using the grid dots recorded in step 3 and table 3.2.4 or table 3.2.5 to estimate areas identified in the aerial photo.



Calculating Area from an Aerial Photo

Based on the aerial photo of this field (1:5,000 scale), determine the number of hectares eligible to receive manure (taking into account required and voluntary setbacks from sensitive areas, obstructions, non-productive areas, etc.).

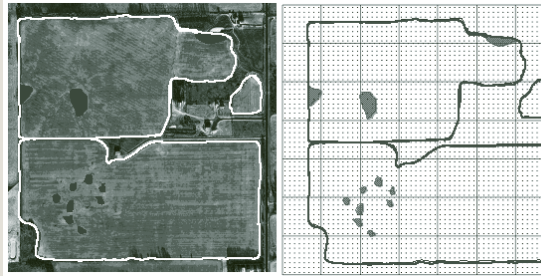

Total number of grid dots in areas with field boundary = **1,440**

Total number of dots in shaded areas (i.e., setbacks, physical obstacles) = **38**

Referring to table 3.2.4, at the 1:5,000 scale, each grid dot is equal to 0.0252 ha.

Total field area (ha) = number of grid dots x ha per grid dot
 = 1,440 x 0.0252
 = 36.3 ha is the total field area which included 1,440 grid dots

Total shaded areas (e.g., setback, obstacles) (ha) = number of grid dots x ha per grid dot
 = 38 x 0.0252
 = 1.0 ha is the total field area which included 38 grid dots

Approximate area available for manure (ha) = Total field area (ha) - Total shaded area (ha)
 = 36.3 x 1.0
 = 35.3 ha of this field is available for manure application

tip



To estimate the area eligible for manure application, trace the outline of fields manure is to be applied, and then outline and fill in any areas ineligible to receive manure (e.g., application setbacks, sensitive areas).

tip



Search for aerial photos online using the external **Aerial Photo Record System (APRS)** website maintained by the **Air Photo Distribution Office**. **APRS** is the database program used to search for photographic projects covering a specific section or block of sections (block searches are not as accurate as specific searches). To complete a search, simply enter the legal land description starting with the section number. Only use the numerical values of a legal description (e.g., the Section, Township, Range, and Meridian numbers). Each set of numbers must be separated by dots, dashes, or spaces (e.g., 34-50-23-4).

APRS Website:
<https://securexnet.env.gov.ab.ca/aprs/index.html>

Username: guest
Password: guest

Air photo(s) can be selected and viewed from the library knowing the year, type of film and scale of photography taken for any given legal land description.

Air Photo Products

The Alberta Government's Air Photo Distribution Office (www.srd.gov.ab.ca/land/g_airphotos.html) houses a collection of over 1.4 million aerial photos of the entire province dating back to 1949. Copies of these photos may be purchased in several formats.

All air photos are produced on demand basis. One copy of each aerial photo is available for viewing in the Distribution Office reference library.

The photographs were taken at many different scales. Common scales available include:

1:20,000 1:30,000 1:40,000 1:60,000

The entire province has been photographed in black and white. Larger scale photography (greater than 1:30000) and colour photography may be obtained for selected areas within the province. Contact the Distribution Office for more information on special photographs.

How to Obtain Aerial Photos

To minimize ordering mistakes, visit the Air Photo Distribution Office in Edmonton. The staff can provide assistance in selecting the right photo and format. Orders can also be placed by calling toll free at 310-0000 then (780) 427-3520, e-mailing air.photo@gov.ab.ca, faxing to (780) 422-9683, or writing to:

Air Photo Distribution
9920 – 108 Street Main Floor
Edmonton, Alberta T5K 2M4

To order an air photo, the following information is required: legal land description, type of product, intended use, mailing address and phone, fax or e-mail address.

The Alberta Soil Information Viewer (ASIV)

The ASIV can be used to view and query soil data for the agricultural area of Alberta. AGRASID Version 3.0 is a digital database of seamless GIS coverage and data files, which describe the soil landscapes for the agricultural regions of the province.

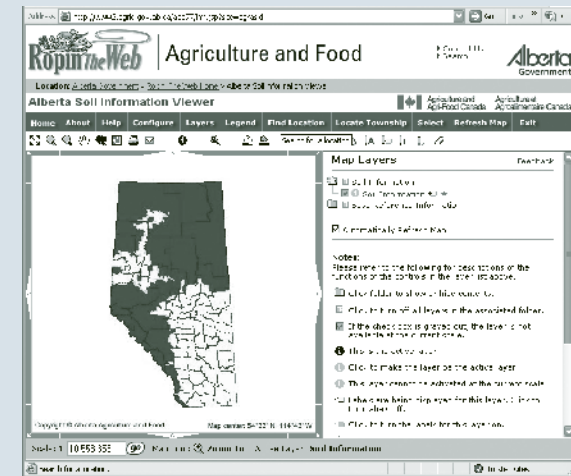

You can view soil related information and colour aerial photos (maximum scale varies by region). Tools are available that allow users to label, mark up and calculate areas on the aerial photos. Finished photos can be printed in PDF format. Tutorials are available to assist new users with features and capabilities of the viewer. For example, instructions on how to manipulate aerial images for nutrient management planning can be found at www.agric.gov.ab.ca/flash/ASIV/manure_presentation.html

The ASIV can be accessed online by entering “soil information viewer” in the search window on **Robin’ the Web**.

➔ summary

- Aerial photos provide a big picture of landscape features. Structures and sensitive areas that should be included on a site assessment are often visible on aerial photos. Water bodies, types of vegetation, and problem soil conditions **can be identified by subtleties in colour and shading on black and white or colour aerial photos.**
- Actual land based distances and areas can be estimated from aerial photos of known scale using simple tools and procedures. The ASIV also has tools that allow areas and distances to be measured easily.
- Aerial photos are available by ordering from the Alberta Government's Air Photo **Distribution Office or using the ASIV.**

Chapter 3.3

Soil Sampling

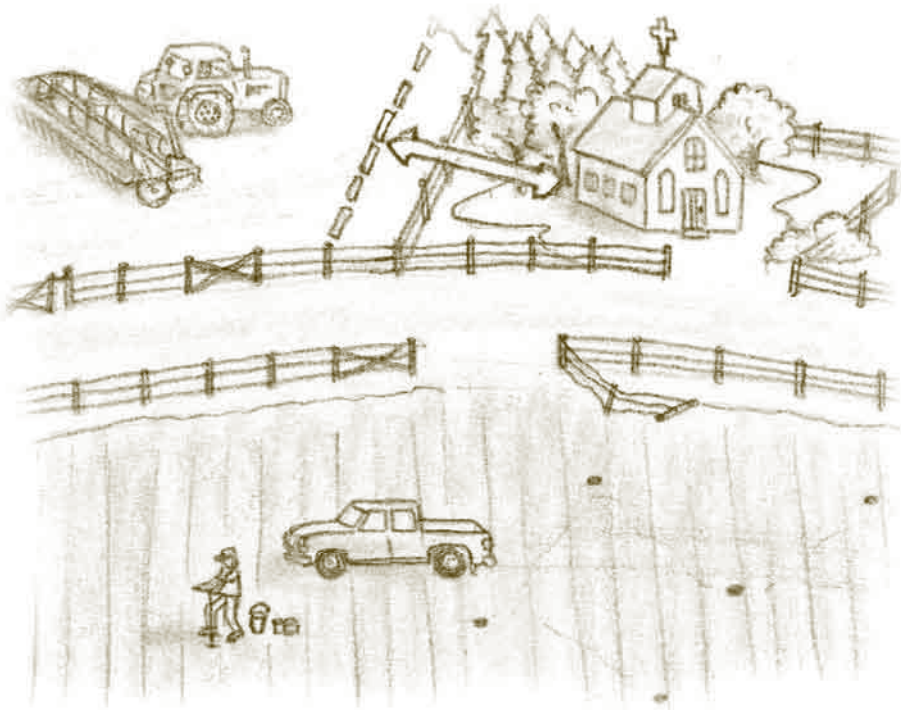

➔ learning objectives

- Choose appropriate times to sample and list **five sampling strategies**.
- Describe the appropriate depth and frequency for sampling.
- Understand how to preserve the quality of samples prior to shipping to a soil testing laboratory.
- List the tests included in a recommended soil sample analysis.
- List information to submit to the lab in order to improve the reliability of fertility recommendations.



Important Terms

Table 3.3.1 Key Terms and Definitions

Term	Definition
Fallow	The practice of leaving the land uncropped and weed free by means of tillage or chemical vegetation control.
Immobile Nutrients	Nutrients having a very low mobility due to low solubility.
Legume	A plant of the botanical family <i>Leguminosae</i> (e.g., pea), which has the ability to fix atmospheric nitrogen through a symbiotic association with <i>Rhizobium</i> .
Nutrient Transformation	The process where by a nutrient is changed from one form to another form (e.g., NH_4^+ changed to NH_3).
Remote Sensed Image	The term generally refers to images (e.g., photos, color infrared, maps) that are generated through the use of instruments aboard aircraft and spacecraft.
Residue or Crop Residue	The portion of plant material remaining in the field after harvest (e.g., straw, roots, stems)

Proper soil sampling is required for accurate soil analyses and reliable nutrient recommendations. Soil analysis provides a “snapshot” of nutrient reserves in the soil, and can be a guide for nutrient applications. Soil samples submitted for analysis should be representative of the field. Obtaining representative samples can be difficult because of soil variability. To get a representative soil sample consider:

- Timing of sampling
- Sampling tools
- Sampling depth
- Sampling frequency
- Sampling strategy or parts of fields to sample
- Appropriate handling of samples

Timing of Sampling

The ideal time to assess soil nutrient status is just before a crop is actively growing and needs soil nutrients. Use the following guidelines to select an appropriate time to sample:

- For spring-sown annual crops collect samples early in spring as soon as the soil has thawed or in the fall once soil temperatures have dropped below 5 to 7 °C (e.g., late October).

- For establishing perennial or fall-sown crops, collect samples about a week prior to seeding and fertilizing.
- In fields with established perennials, sample annually in the spring before active growth begins.

Fall Sampling

If spring sampling is not possible, sample in the previous fall after soil temperatures drop below 5 to 7°C. When soils cool to this range, soil microbial processes that affect crop available nutrients (e.g., mineralization) slow down. Consequently, further changes in plant available nutrient levels are minor. Fall sampling allows time to properly process samples, and get test results and nutrient recommendations to develop nutrient application strategies.

In most areas of Alberta, it is generally safe to begin fall sampling by the middle of October. Fall sampling in forage fields can begin anytime after September 1st.

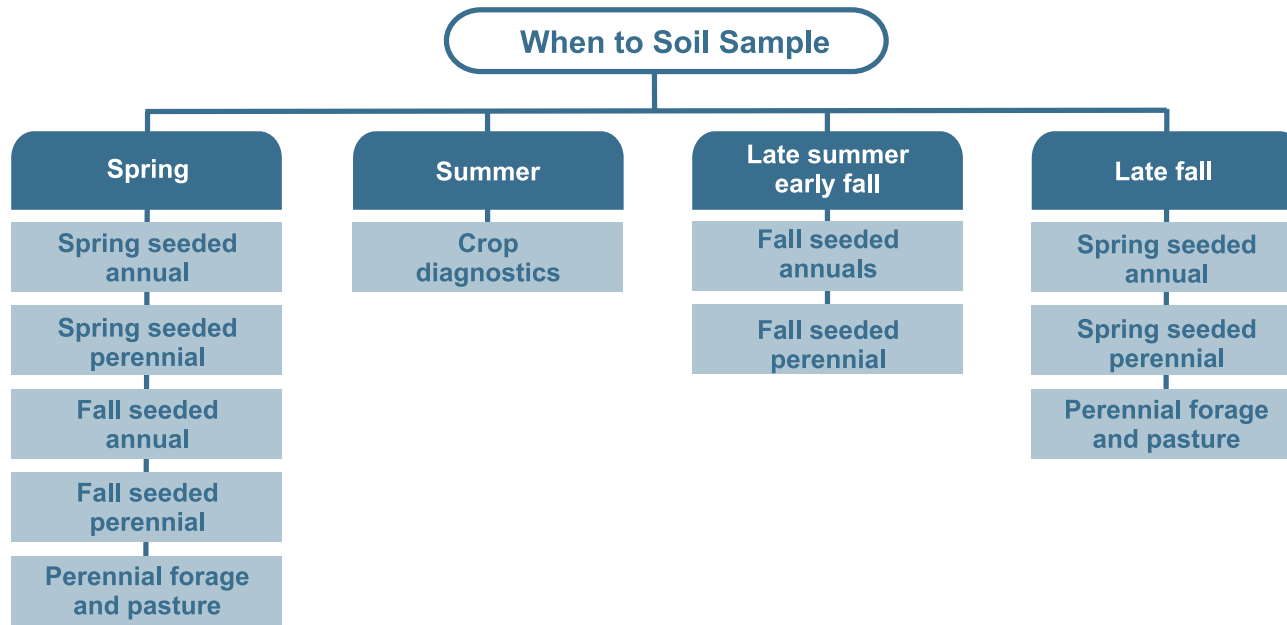

Figure 3.3.1 Timing of Soil Sampling

Source: Kryzanowski, 2007

s i d e b a r

Always sample fields prior to nutrient application. Collecting representative samples from fertilized or manured fields is more difficult.

s i d e b a r

Avoid sampling frozen or water-logged soils. It is difficult to obtain representative samples for these conditions.

tip



Before sampling or having a field sampled, be sure to identify the location of any underground utilities. Failing to identify these can result in personal risk and financial liability.

Call Alberta One-Call at 1-800-940-3447 before sampling to have underground utilities identified.

tip



Core samplers allow reliable separation of sampling depths. Auger type samplers result in too much mixing between sample depths, resulting in poor soil samples.

Sampling Tools

Soil sampling tools (Figure 3.3.2) can be purchased from equipment supply companies. Alternatively, sampling equipment can be borrowed from fertilizer dealers, private labs, or crop advisors. For samples deeper than 30 cm (1 ft) truck mounted hydraulic coring equipment is recommended. Many fertilizer dealers offer soil sampling services.



Photos courtesy Crystal Korth, AF and Natural Resource Conservation Service

Figure 3.3.2 Manual and Truck Mounted Soil Sampling Probes

To collect a quality sample, insert the sampling probe straight into the ground (Figure 3.3.3). Avoid inserting the probe on a slant, because this will reduce the accuracy of the sample.

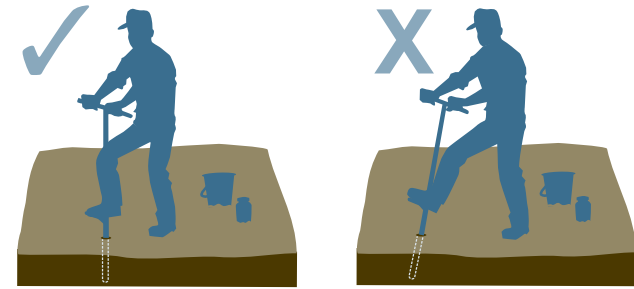

Figure 3.3.3 Correct and Incorrect Insertion of a Soil Sampling Probe

Sampling Depth

It is recommended that samples be taken from the following depths to get the best estimate of soil nutrient levels to optimize nutrient management:

- 0 to 15 cm (0 to 6 in)
- 15 to 30 cm (6 to 12 in)
- 30 to 60 cm (12 to 24 in)

Soil testing laboratories can develop fertilizer recommendations from a 0 to 15 cm depth sample, but these recommendations make assumptions about nutrient content in deeper layers. More reliable fertility recommendations and better nutrient management decisions can be made when nutrient levels are measured rather than estimated (e.g., for nitrogen and sulphur).

Sampling for Nitrate and Sulphate

Nitrate nitrogen ($\text{NO}_3\text{-N}$) and sulphate sulphur ($\text{SO}_4\text{-S}$) are mobile nutrients that may be found in significant amounts in the 15 to 60 cm depth. Therefore, N and S fertility recommendations should be based on extractable NO_3^- and SO_4^{2-} contents in a 0 to 60 cm deep soil sample. Nitrogen and S recommendations could be incorrectly estimated if they are solely based on a 0 to 15 cm depth sample. Separate sample depths provide more reliable estimates of $\text{NO}_3\text{-N}$ and $\text{SO}_4\text{-S}$ in the soil profile.

Sampling for Phosphorus and Potassium

Phosphorus and K recommendations are based on the amounts of crop available P and K contained in the 0 to 15 cm depth sample. Generally, most of the plant available P in soil is confined to the plow layer because P is relatively immobile.

Sampling Frequency

Ideally, all fields should be sampled and tested annually, but this may not always be practical. Alternatively, samples may be taken from representative fields and the resulting recommendations can be used to manage unsampled fields. Fields could also be sampled every other year, with estimates used in years between samplings to make fertility decisions. In both cases, the cost and time requirements associated with sampling are reduced; however, nutrient management decision-making may be less precise.

Sampling Strategies

Soil variability is a major concern when trying to obtain a representative soil sample. The strategy used to sample a field can address this challenge. Information collected during a site assessment can assist in choosing an appropriate strategy for a particular field.

Some of the sampling strategies that can be followed include:

- Random composite sampling
- Directed random composite sampling
- Benchmark sampling
- Landscape-directed benchmark sampling
- Grid sampling

General Soil Sampling Guidelines

For any soil sampling strategy:

- Take 15 to 20 cores for each representative bulk sample. This number of samples is based on statistical precision.
- Each core will be segmented into lengths that represent depths of 0 to 15 cm, 15 to 30 cm and 30 to 60 cm.
- Separate the segmented cores by depth into clean, labeled plastic pails. Thoroughly mix the content of each pail, crushing any lumps in the process. Avoid using metal pails to collect samples because they can alter the results of micronutrient tests.
- Take a single sub-sample (0.5 kg) for each sampling depth and submit for analysis.
- For hilly fields with knolls, slopes, or depressions, take samples from mid-slope positions to get a representative sample of the field average.
- Avoid sampling obvious areas of unusual variability such as: saline areas, eroded knolls, old manure piles, burn piles, haystacks, corrals, fence rows, old farmsteads or any other unusual areas.
- Soils within 15 m (50 ft) of field borders or shelterbelts and within 50 m (150 ft) of built-up roads should be avoided or sampled separately.
- Always sample prior to manure or fertilizer applications.

sidebar

Under AOPA, fields that will receive manure must be soil tested a minimum of once every three years.

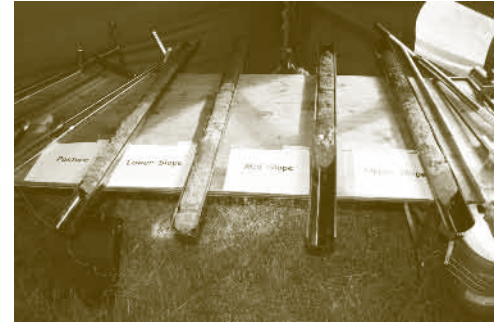

sidebar

Recall that soil analysis requirements under AOPA require a sample representing the entire 0 to 60 cm (0 to 24 in) depth to measure NO₃-N.

more info



A list of labs that analyze soil samples is included in the Appendices.



Random Composite Sampling

Random composite sampling involves taking samples in a random pattern across a field, while avoiding unusual or problem soil areas (Figure 3.3.4). This strategy is most appropriate for fields less than 30 ha (80 ac), that have been uniformly cropped in the recent past and have little natural variation. This is the most common method of sampling presently used in Alberta.

For random sampling, collect cores from 15 to 20 sites and separate each core by depth (see General Soil Sampling Guidelines) to obtain representative bulk samples for each depth.

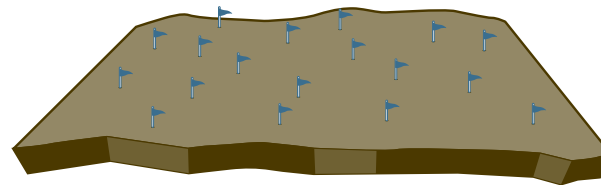

▤ = Probe site

Figure 3.3.4 Random Composite Sampling Pattern.

Directed Random Sampling

Directed or managed random sampling is a modified version of a random sampling strategy (Figure 3.3.5). This pattern is suited to fields or areas where it is difficult to identify a single dominant area that would represent most of the field.

Sub-divide the field into management zones based on unique characteristics. For instance, if there are noticeable differences in yield throughout a field, management zones might be comprised of below-average, average and above-average yielding areas. Take 15 to 20 cores (see General Soil Sampling Guidelines) randomly from each management zone. A single field may require several bulk samples depending on the number of management zones.

This strategy might also be appropriate for areas with more than one soil type, fields with hummocky (rolling) landforms, and fields under strip-crop management.

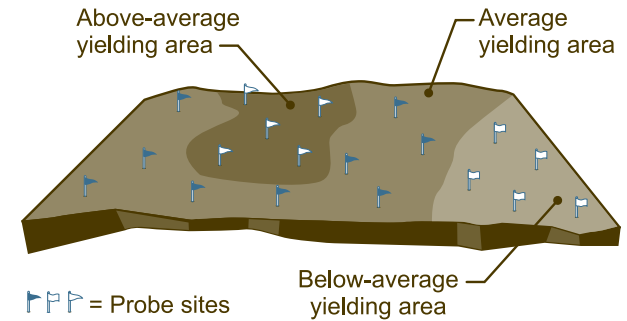

Figure 3.3.5 Directed Random Sampling Pattern

Benchmark Sampling

Benchmark sampling involves selecting a small (30 m by 30 m) representative site on a field (Figure 3.3.6). This site is used as a guide for fertilizing that entire field. Select probe sampling sites in a grid pattern within the benchmark area and prepare a composite sample for each soil depth. Sampling from the same small area each year reduces sampling variability and better reflects changes in soil nutrient level from year to year. Benchmark sampling sites should be marked with a GPS or by other means.

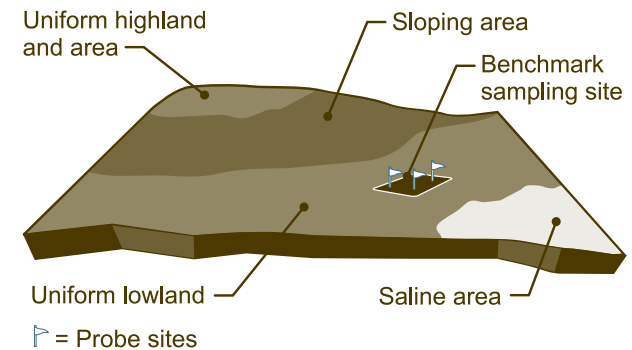

Figure 3.3.6 Benchmark Sampling Pattern

When first using this strategy, it can be difficult to select a benchmark site that best represents a field. Therefore, in the first year, it may be necessary to sample and analyze a number of potential benchmark sites. Initially, the costs for laboratory analysis will be higher but the most representative benchmarking site will be identified. If a single site does not adequately represent a field, it may be necessary to maintain multiple benchmark areas (i.e., directed benchmark sampling, see next section).

Selecting a Benchmark Site

When selecting a benchmark site, look for features such as soil colour and landscape to identify where different soil types occur. Select a site that has characteristics similar to most of the field or the dominant soil type.

Observe crop development patterns to assist in identifying different soil conditions. At the beginning of the growing season differences in crop establishment and vigor are more apparent, making a representative location easier to identify. Potential benchmark sites can also be selected based on yield, aerial photos or topographic maps.

Benchmarking is rapidly gaining popularity in Alberta, particularly with increased use of GPS. GPS coordinates help to identify and locate the benchmark site for sampling each year.

Directed Benchmark Sampling

Directed benchmark sampling is a variation on the benchmark technique. It involves establishing multiple benchmark areas and management zones, based on topography or other characteristics (Figure 3.3.7).

This strategy can be used when major areas within fields have distinct and well-defined features related to

moisture (e.g., texture, slope). Management zones can be identified using soil surveys, detailed elevation mapping, aerial black and white photographs, yield maps or remote sensed images.

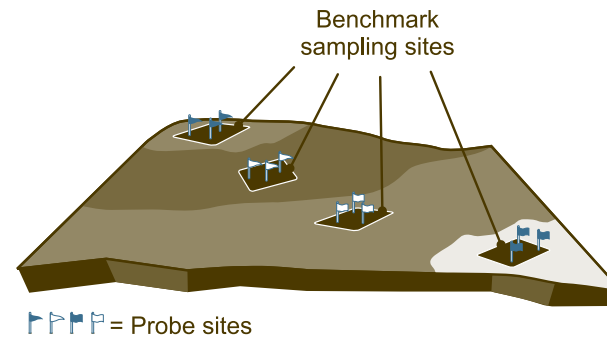

Figure 3.3.7 Landscape Directed Benchmark Sampling Pattern

Directed benchmark sampling is only warranted if distinct areas are managed individually. For example, a soil analysis from a benchmark site in a low area suggests that it might respond to higher rates of N compared to a benchmark site on an upland area. Even without variable rate application capabilities, N application could be increased by other means to optimize yield in low areas.

Grid Sampling

Grid sampling is the most intense and expensive sampling strategy (Figure 3.3.8). It uses a systematic method to reveal fertility patterns and assumes there is no topographic reason for fertility patterns to vary within a field.

For grid sampling, a field is divided into small areas or blocks. A sample location within each block (e.g., the center point) is sampled 3 to 10 times. Sampling frequency may range from one sample from each 60 m × 60 m (0.5 ac) area of the field to one sample from each 2 ha (5 ac) of the field. In general, the smaller the sampling unit, the greater the accuracy.

tip



Experience from the United States indicates that a sampling density of one bulk sample per acre is required to provide accurate information for variable rate fertilization. Sampling larger areas may still provide useful information about the extent of field variability.



tip



Prior to soil sampling, contact the soil testing laboratory for more information regarding handling and shipping soil samples. In many cases, the lab will provide collection containers and/or shipping bags along with forms requesting information on cropping and management history of the sampled field. This information is used with test results to develop fertilizer recommendations. Some labs offer reduced rates for large numbers of samples or may pay the shipping costs.

more info



For more information on soil analysis requirements and other requirements under AOPA, search Ropin' the Web (keyword: AOPA), or contact the Publications Office in Edmonton (1-800-292-5697).

The major benefit of grid sampling is that a field map can be prepared for each nutrient which can facilitate variable rate fertilizer application. However, the cost of analyzing the required number of samples makes this technique uneconomical for many producers.

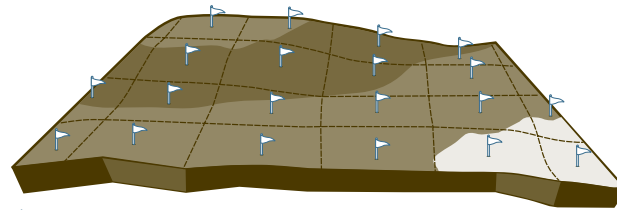

🚩 = Probe sites

Figure 3.3.8 Grid Sampling Pattern

Selecting the Appropriate Soil Sampling Strategy

The suitability of various sampling strategies is based on field variability or sampling intensity, relative cost and the amount of information desired (Figure 3.3.9).

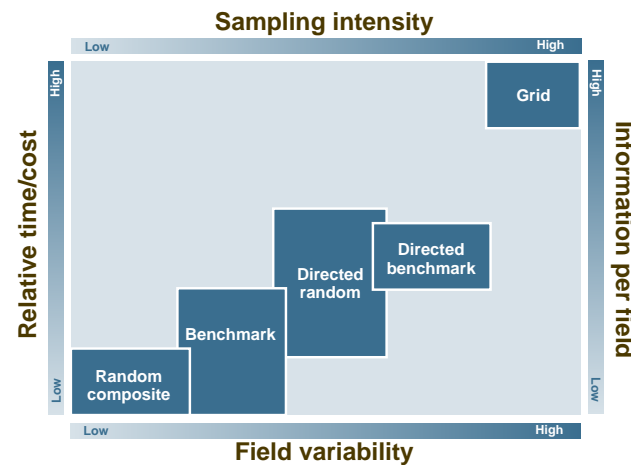

Source: Kryzanowski, 2007

Figure 3.3.9 Suitability of the Various Sampling Strategies

Soil Sampling and AOPA

Under AOPA, confined feeding operations (CFOs) in Alberta that apply less than 500 tonnes (550 tons) of manure, compost or composting materials annually are exempt from the required soil analysis prior to land application. However, producers applying more than this amount require a soil analysis for fields scheduled to receive the material. For these fields, a test no older than three years is required (with the exception of soil texture, which is a one-time analysis) and must include:

- Extractable nitrate nitrogen (NO₃-N) in the 0 to 60 cm (0 to 24 in) depth.
- Electrical conductivity (EC) in the 0 to 15 cm (0 to 6 in) depth.

Handling and Shipping Soil Samples for Analysis

Proper handling of soil samples prior to analysis will help ensure reliable test results. This section will describe proper handling techniques for moist samples, drying samples before shipping, and shipping samples.

Handling Moist Samples

If possible, moist samples should be delivered to the laboratory on the day they are collected. If this is not possible, samples can be refrigerated for a couple of days or frozen for a longer period. Refrigerating or freezing the samples stops microbial activity. This activity could result in nutrient transformations and affect the results of the analysis. Ensure moist samples spend no more than two days in transit.

Drying Samples Prior to Shipping

If samples cannot be sent to the laboratory immediately, they can be air dried by:

- Spreading out each soil sample on a clean surface (aluminum pans, plastic trays, etc.).
- Allow the sample to completely air dry at a temperature no more than 30°C. If desired, a fan may be used to ensure constant airflow over samples to enhance drying. Do not dry in an oven, microwave or at a high temperature. This can change the levels of some nutrients, invalidating test results, and fertilizer recommendations.

Shipping Samples

When shipping samples to the soil testing laboratory:

- Fill the soil sample bags or cartons with 0.5 kg (1 lb) of soil.
- Label each container with the information specified by the testing facility including: date of sampling, field number, contact name and sample depth.
- Complete an information sheet on cropping and fertilizer history. Note in detail where unusual problems exist.
- Ensure that samples do not become contaminated with anything that might invalidate test results (e.g., fertilizer).

Laboratory Analyses

Consult the soil testing laboratory regarding available analysis packages. Typical soil analyses packages for surface (0 to 15 or 0 to 30 cm) agricultural soils should include soil analyses for:

- extractable nitrate nitrogen
- available P
- available K

- extractable sulphate sulphur
- soil pH
- salinity (electrical conductivity)

Nitrate and sulphate analysis should be completed for subsurface soil samples (15 to 30 and 30 to 60 cm). If high levels of $\text{NO}_3\text{-N}$ or available P are suspected, ask the lab to dilute the extract to get exact NO_3^- and available P levels.

Additional analyses can also be requested for:

- micronutrients (boron, chloride, copper, iron, manganese or zinc)
- organic matter
- texture (usually a one-time analysis)

Information to Submit with Samples

Soil samples should always be accompanied by information about the site, cropping expectations and management. This will put soil analysis results in context and lead to relevant fertility recommendations. Some of the information that should be submitted includes:

- **Legal land description or location:** This information is used to make assumptions about precipitation, soil zone, organic matter content, and length of the growing season. It can also be used to identify samples sent for analysis and for field records.
- **Planned crop rotation:** Planned rotation is used to determine fertility and nutrient requirements, which should be based on provincial yield response curves. The planned crop rotation will have implications for nutrient management due to differences in crop nutrient demand. Fertility recommendations based on test results can be developed for several different crops. Economics can then be factored into decision-making based on recommendations.

tip



Use a reputable soil testing laboratory that uses Alberta data to determine fertilizer recommendations. Keep a copy of sample information sheets and a completed field plan of the area represented by each sample. Follow the packing and shipping instructions provided by the lab.



sidebar

Information sheets, soil sample cartons, and shipping boxes are available from soil testing laboratories.

tip



Realistic yield goals may be estimated from historical yields, seed

providers, regional variety trials, provincial averages, agronomists or service providers, specialists at the Ag-Info Centre, county offices or regional applied research associations.



- **Realistic yield goals:** A realistic yield goal is one that is achievable for a crop grown in a given area under a particular management system. Yield goals must take into consideration previous year's crop, current and predicted moisture conditions, crop varieties, and time of year.
- **Previous crop:** This is particularly important if the previous crop was a legume or if the field was fallowed. Soil available N levels after fallow are generally higher and should be reflected in the soil analysis results. Legume residues will also provide N to subsequent crops; however, this N will not be detected in a standard soil analysis but will factor into fertility recommendations made by the lab.
- **Irrigated versus non-irrigated land:** Productivity (i.e., potential yield) and fertility recommendations will be higher for irrigated crops.
- **Residue management:** Crop residues have implications for nutrient availability to subsequent crops. Cereal and oilseed residues will immobilize nutrients reducing availability for the immediate needs of subsequent crops. Fertilizer recommendations are lower when straw is baled and removed than when it is spread.
- **Manure and fertilizer application history:** When making fertility recommendations, labs will consider previous nutrient applications (type or rates). When soil samples are taken immediately following manure or fertilizer application, some nutrients (e.g., NH_4^+) will not show up in standard soil analysis results. Likewise, organic nutrients from previous manure applications will become available gradually during the growing season and will not be reflected in test results. Without the nutrient application history, fertility recommendations may be inflated.
- **Moisture conditions:** Yield response is closely tied to moisture conditions. By reporting this information to the lab, fertility recommendations will be adjusted accordingly.

summary

- Soil sampling for nutrient management purposes should occur immediately before seeding, just prior to active growth or in the fall after soil temperatures drop below 5 to 7 °C.
- Sampling strategies include random sampling, directed random sampling, benchmark sampling, directed benchmark sampling and grid sampling. Benchmark sampling is the recommended sampling method for most situations, while grid sampling is the most intensive.
- To accurately assess nutrient levels, samples should be collected from the 0 to 15 cm, 15 to 30 cm and 30 to 60 cm soil depths.
- For best management, samples should be collected and analyzed annually. **AOPA regulations require that all fields receiving manure must have a soil analysis that is not older than three years.**
- Make sure samples are handled appropriately based on laboratory guidelines to ensure reliable test results. Moist samples should be kept cool and sent to the lab immediately. Samples that cannot be immediately shipped should be dried or frozen.
- Recommended analyses for samples include tests for: extractable NO_3^- , available P, available K, extractable SO_4^{2-} , pH and salinity (electrical conductivity).
- Soil samples submitted for analysis should be accompanied by information regarding legal land location, a realistic yield goal, production and management system information, and prior manure or fertilizer application history.

Chapter 3.4

Practical Use of Soil Analysis Results

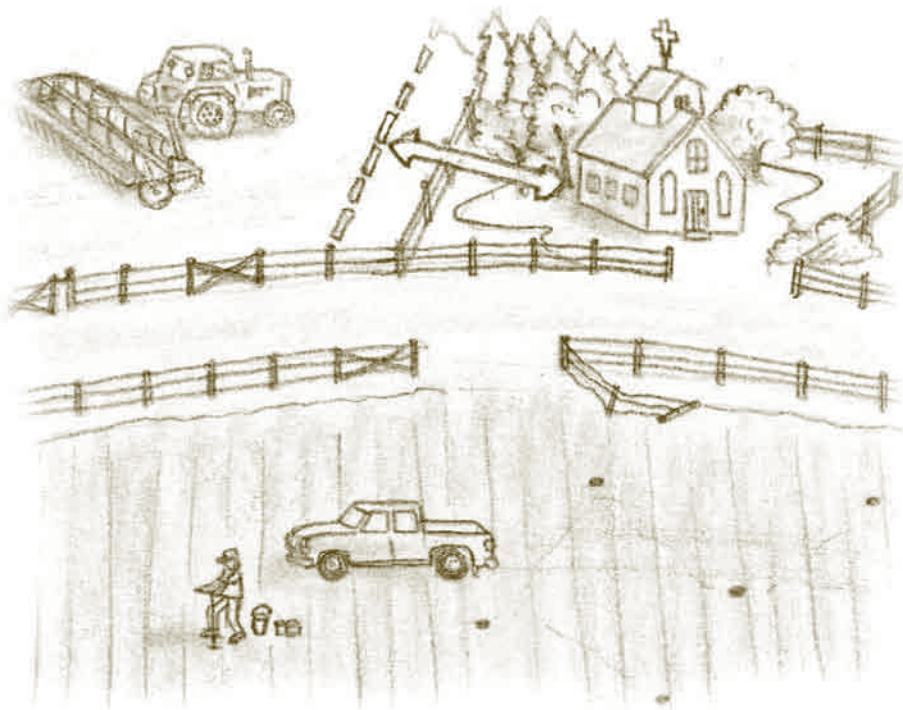

➔ learning objectives

- Identify analytical results from nutrients, organic matter, pH, EC and CEC from the lab report.
- Interpret soil analysis results for pH and salinity.
- Describe the significance of soil CEC, soil organic matter content and soil texture.
- Describe the importance of soil available moisture and how it is characterized.
- Understand why laboratories differ in their analytical results and recommendations.

more info



Refer to Chapter 3.3 for more information on how to collect

a quality, representative soil sample from a site.



Important Terms

Table 3.4.1 Key Terms and Definitions

Term	Definition
Atoms	The smallest particle of an element that can exist as a stable entity, either alone or in combination.
Atomic Weight	The average mass of an atom of an element as it occurs in nature. This is made up of the weighted sum of the masses of the protons and neutrons composing the atom.
Labile	Readily or continually undergoing chemical, physical or biological change or breakdown. A substance readily transformed by micro-organisms or readily available to plants.

The soil analysis report provides the information necessary to set nutrient application targets, which are used to calculate manure and fertilizer application rates. Test results from regular field sampling (particularly from benchmark sites) allow monitoring and detection of changes in soil parameters (e.g., nutrients, pH, and salinity) with time.

Soil analysis results must be interpreted within the context of expected yield response for the crop to be

grown under specific environmental and management conditions. The interpretations discussed in this chapter are specific to Alberta soils and are based on extensive field and laboratory research. The results of a lab analysis are only as good as the quality of the samples collected and the sampling strategy used. Poor samples that are not representative of field conditions will lead to inaccurate nutrient recommendations.

Address: ABC Farms Box 123 My Town, AB TOG 0N0				Grower Name: Joe Smith Client's Sample ID: 1a Field ID: Brown Place Legal Location: NW 6-39-29-W4				Tracking Number: 200610-01999 Date Received: October 19, 2006 Report Date: October 26, 2006 Disposal Date: November 30, 2006								
Nutrient Analysis (PPM)												Quality				
Depth	N	P	K	SO ₄	Cl	Cu	B	Ca	Mg	Fe	Zn	Mn	pH	EC	OM	Texture
0 - 6"	4	11	175	19	12	0.6	0.7	800	300	3	1.5	2.5	6.7	0.4	5.5	Loam
6 - 12"	1			10												
12 - 24"	1			8												
Total																
Range	D	D	A	A	M	M	A	A	A	M	A	A	Neutral	Good	Normal	
E: Excess A: Adequate M: Marginal D: Deficient																
lb/ac	14	22	350	90									Cation Exchange			
Available lb/ac	14	22	350	90									TCEC: 44 meq/100g			
													BS: 100%			
													Ca	Mg	K	Na
													55%	35%	9%	1%

Recommendations (lb/ac)															
Crop	Conditions	Yield	N	P ₂ O ₅	K ₂ O	S	Cl	Cu	B	Ca	Mg	Fe	Zn	Mn	
Wheat	Excellent	68	125	30	0	0	0	0	0	0	0	0	0	0	
	Average	57	100	25	0	0	0	0	0	0	0	0	0	0	



Figure 3.4.1 General Appearance of a Soil Analysis Report

side bar

Nutrient levels are converted from ppm to lb/ac by multiplying by two because a one acre slice of soil, six inches deep weighs approximately two million pounds. In other words, lb/ac is essentially parts per two million. For a soil sample 12 inch deep, multiply ppm by 4.

side bar

Soil test P and K levels are reported on an elemental basis (i.e., P or K) rather than oxide basis (i.e., P₂O₅ or K₂O).

Reading Soil Analysis Reports

All laboratories generate reports for each sample submitted for analysis. All reports will contain the same basic information although individual labs may present this information in their own unique format. Figure 3.4.1 is an example of the general layout of information on a soil analysis report.

The report will identify the client (# 1 in Figure 3.4.1) as well as the unique sample identification (#2 in Figure 3.4.1). When reviewing soil analysis reports, verify that the sample identification is correct. Although it may seem of minor significance, the legal land location is often used to identify agro-climatic regions that affect yield expectations and fertilizer recommendations.

The report will usually indicate when the sample was received and when it was processed (#3 in Figure 3.4.1). Review these handling dates to see if there were any unusual delays in shipping that might affect the accuracy of the results. Take note of the length of time the sample will be retained (#3 in Figure 3.4.1). Additional analysis or repeated tests to verify unusual results must be performed while the sample is still available.

The nutrient analysis (#4 in Figure 3.4.1) is the heart of the report but it is often overlooked compared to the fertilizer recommendation. The nutrient analysis is a measurement of the nutrients removed from soil using an extracting solution. These results form the basis for fertilizer recommendations.

Labs use diverse extraction methods so the nutrient analysis of one lab is not directly comparable to another lab unless both are using the same procedures. An individual lab may use various extracts for different nutrients in order to get the most reliable results. Find out what methods a lab follows since some extraction methods may not be suited to western Canadian soils.

For nutrient management purposes, it is useful to use the same lab every year or to use labs that follow the same extraction processes to track nutrient level changes with time.

Nutrient levels are reported in parts per million (ppm or mg/kg). For each 15 cm (6 in) sample depth, these values can be doubled to approximate the nutrient levels on a kilograms per hectare (kg/ha) or pounds per acre (lb/ac) basis (#5 in Figure 3.4.1).

$$\begin{aligned} \text{Nutrient (kg/ha)} &= \\ \text{Nutrient (ppm)} \times 2 \times \text{sample depth (cm)} \div 15 \text{ cm} \end{aligned}$$

$$\begin{aligned} \text{Nutrient (lb/ac)} &= \\ \text{Nutrient (ppm)} \times 2 \times \text{sample depth (in)} \div 6 \text{ in} \end{aligned}$$



A soil analysis report indicates there is 10 ppm N in a 0 to 6 in soil sample. This corresponds to 20 lb N/ac:

$$\begin{aligned} \text{Nutrient (lb/ac)} &= \\ &= \text{nutrient (ppm)} \times 2 \times \text{sample depth (in)} \div 6 \text{ in} \\ &= 10 \text{ ppm} \times 2 \times 6 \text{ in} \div 6 \text{ in} \\ &= 20 \text{ lb N/ac} \end{aligned}$$

There is 10 ppm N in a 0 to 12 in sample. This corresponds to 40 lb N/ac:

$$\begin{aligned} \text{Nutrient (lb/ac)} &= \\ &= \text{Nutrient (ppm)} \times 2 \times \text{sample depth (in)} \div 6 \text{ in} \\ &= 10 \text{ ppm} \times 2 \times 12 \text{ in} \div 6 \text{ in} \\ &= 40 \text{ lb N/ac} \end{aligned}$$

Examine reported nutrient levels for any unusual values. Soil N levels following average or above average crops should be low (i.e., below 15 ppm and often less than 10 ppm for 0 to 15 cm (6 in) depths). Phosphorus levels for fields that have not received manure should not vary

much from year to year and are typically quite low (less than 15 ppm for 0 to 15 cm depth). On fields with a history of manure application, the N and P levels may be considerably higher. Potassium levels of Alberta soils are relatively stable, often quite high (more than 150 ppm in 0 to 15 cm depth) and may exceed 500 ppm on Brown and Dark Brown soils, even without a history of manure application. Sulphur levels are variable and can range from less than 5 ppm to more than 50 ppm for 0 to 15 cm depth. Large year-to-year changes in soil nutrient levels should be investigated to determine the cause (e.g., management changes, change in analytical method, or mishandling of samples).

Excess nutrient levels may be suggested on a soil analysis report when nutrient levels are reported as being greater than a lab threshold (e.g., K is more than 600 ppm). Unless a dilution is performed, the lab will not be able to provide an exact nutrient level. While this has minimal influence on crop production, it can suggest nutrient levels that pose potential environmental risk. If high levels of nitrate (NO_3^-) or P are suspected in a field, ask the lab to dilute the extract to get exact NO_3^- and P levels.

Soil analysis reports often include a subjective rating of nutrient levels (#6 in Figure 3.4.1) based on the probability that a particular nutrient will limit plant growth and production. Often these ratings are depicted as bar graphs for each nutrient. These subjective ratings may also help identify potential environmental risk.

For most soils, micronutrient levels are usually in the marginal range but are occasionally adequate or deficient. The probability of crop response to micronutrient application is not clear in many instances.

Soil quality factors including pH, salinity, organic matter, and texture (#7 in Figure 3.4.1) provide information useful for the site assessment and crop selection. Often soil quality factors will have a rating system that may flag potential problems.

Labs based in western Canada do not emphasize the total cation exchange capacity or the composition of exchangeable cations (#8 in Figure 3.4.1). These analyses are usually included at additional costs. Other labs may recommend nutrient additions to “balance” exchangeable ions but there is little research evidence to support this practice.

Fertilizer recommendations are usually based on yield response curves or yield expectations (#9 in Figure 3.4.1) for a crop based on soil moisture and growing season precipitation. Some labs will provide more than one set of recommendations to account for different rainfall conditions (e.g., average and excellent). Fertilizer application rates can then be adjusted or selected based on expected rainfall.

Crop Nutrients

One of the basic principles behind formulating fertility requirements relates to the probability of a crop response to nutrient application (Figure 3.4.2).

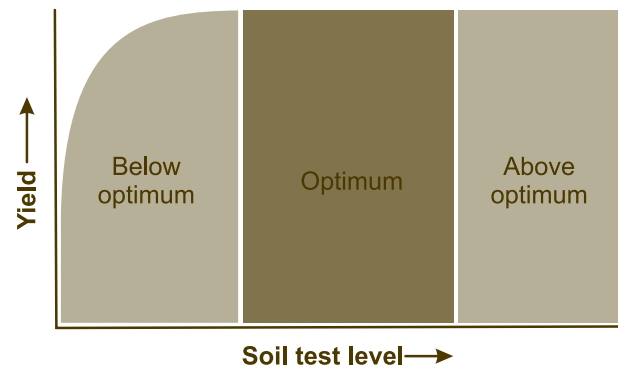

From Beegle, 2006

Figure 3.4.2 Yield Response in Relation to Soil Nutrient Levels

tip



Contact the soil testing laboratory with specific questions about the analytical techniques used to measure individual soil.



sidebar

Often kg/ha and lb/ac are interchanged and considered to be equal. However, the actual conversion is $\text{kg/ha} \times 0.8924 = \text{lb/ac}$.

Practical Use of Soil Analysis Results

Soils that test in the deficient range for a particular nutrient have a high probability of improved yield if that nutrient is applied. Soils that test in the adequate range are not likely to see an improvement in yield as a result of nutrient application (Table 3.4.2).

Table 3.4.2 Generalized Deficient, Marginal, and Adequate Ranges of Various Crop Nutrients for Alberta Soils

Soil Test Nutrient	Depth, cm (in)	Classification ¹								
		Deficient ²			Marginal			Adequate		
Nitrate-Nitrogen (Dryland) (lb/ac)	0–60 cm (0–24 in)	< 11	11–20	21–30	31–40	41–50	51–60	61–70	71–80	> 80
Nitrate-Nitrogen (Irrigated) (lb/ac)	0–60 cm (0–24 in)	< 21	21–40	41–60	61–80	81–100	101–120	121–140	141–160	> 160
Phosphorus (lb/ac)	0–15 cm (0–6 in)	< 11	11–20	21–25	26–30	31–40	41–50	51–70	71–90	> 90
Potassium (lb/ac)	0–15 cm (0–6 in)	< 51	51–100	101–150	151–200	201–250	251–300	301–400	401–600	> 600
Sulphur (lb/ac)	0–60 cm (0–24 in)	< 6	6–10	11–15	16–20	21–25	26–30	31–40	41–50	> 50
Copper (ppm)	0–15 cm (0–6 in)	< 0.5			0.5-1.0			> 1.0		
Manganese (ppm)	0–15 cm (0–6 in)	< 1.0			1.0-2.0			> 2.0		
Iron (ppm)	0–15 cm (0–6 in)	< 2.0			2.0-4.0			> 4.0		
Zinc (ppm)	0–15 cm (0–6 in)	< 0.5			0.5-1.0			> 1.0		
Boron ¹ (ppm)	0–15 cm (0–6 in)	< 0.35			0.35-0.50			0.50-3.50		
Chloride (ppm)	0–15 cm (0–6 in)	< 15.0			16-30			> 30		

Adapted from Kryzanowski et al., 1988

¹ Nutrient range for each classification will vary with crop type and soil zone.

² Boron levels above 3.5 ppm are considered excessive.

³ To convert lb/ac to kg/ha, multiply by 1.1206.

pH

Soil pH (or reaction) indicates acidity or alkalinity of the soil. Soils below pH 6.7 are acidic and soils above pH 7.3 are alkaline. A pH near 7.0 is considered neutral. A more descriptive classification of soil pH is based on the ranges described in Table 3.4.3.

Table 3.4.3 Qualitative and Quantitative Descriptions of pH for Alberta Soils

3.0–5.6	5.6–6.2	6.2–6.7	6.7–7.3	7.3–7.9	7.9–8.5	>8.5
Strongly Acidic	Moderately Acidic	Slightly Acidic	Neutral	Slightly Alkaline	Moderately Alkaline	Strongly Alkaline

Source: Kryzanowski et al., 1988

Under low pH conditions, some nutrients bind tightly to soil particles and as a result are unavailable to plants. In addition, chemical structures of some nutrients, particularly P, can change under low pH making them less available to crops. Low pH conditions also impact the growth and survival of soil microorganisms, some of which are instrumental in releasing nutrients bound in organic matter for crop use.

Crops vary in their acidity tolerance (Figure 2.2.5) which is strongly influenced by the sensitivity of crops to various levels of soluble aluminum (Al^{3+}). Aluminum solubility increases substantially under strongly acidic conditions. Crops produced in soils more acidic than their tolerance level will result in reduced yields. Fertilizer recommendations should be adjusted for reduced yield potential on the basis of crop type and pH.

To contend with soil acidity, select acid tolerant crop types or consider liming the soil to correct the high pH condition. Before applying lime, request a lime requirement test which will provide a recommendation for an appropriate rate. Liming acid soils can be an extremely costly procedure so the potential return on investment should be carefully assessed. More information about soil pH and acid soil conditions can be found in Chapter 2.2.

Salinity

There are two soil parameters used to characterize soils as saline, sodic or saline-sodic. These are electrical conductivity (EC) and sodium adsorption ratio (SAR). Only EC is part of routine agricultural soil analysis.

EC

Soluble salts are present in soils at all times; however, when the concentration of salts is high, the soil is considered saline and crop growth can be reduced. EC is a measure of the total soluble salt concentration in a soil (i.e., salinity). It is determined by measuring the ability of a small current to be transmitted through saturated soil between two electrodes of a conductivity meter that are a fixed distance apart. The units commonly used to express EC are decisiemens/metre (dS/m). Soils are classified on the basis of salinity according to the EC ranges specified in Table 3.4.4.

more info



For more information on liming acid soils can be found in the factsheets below, which can be ordered from the AF Publications Office or searched by Agdex number on Ropin' the Web:

- AF. 1996. Liming acid soils. **Agdex 534-1.**
- AF. 2002. Wood ash: An alternative liming material for agricultural soils. **Agdex 534-2.**





Table 3.4.4 Salinity Ratings for Alberta soils in Relation to Electrical Conductivity Measurements

Soil Depth	Salinity Classifications and EC Measurements (dS/m)				
	Non-Saline	Weakly Saline	Moderately Saline	Strongly Saline	Very Strongly Saline
0–60 cm (0–2 ft)	< 2	2–4	4–8	8–16	> 16
60–120 cm (2–4 ft)	< 4	4–8	8–16	16–24	> 24

Source: Kryzanowski et al. 1988

Crops exhibit a range of tolerance to salt levels in the soil (Table 3.4.5). In general, grass forages tend to have a higher salinity tolerance than field crops.

Table 3.4.5 Salt Tolerance of Selected Crops

EC (dS/m) (Salt Tolerance)	Field Crops	Forages	Vegetables
20 (Very high)		Beardless wildrye, Fulks altai grass, Levonns alkaligrass, Alkali sucatan	
16 (High)	Kochia Sugar beet	Altai wildrye, Tall wheatgrass, Russian wildrye, Slender wheat grass	
8	6-row barley, Safflower, Sunflower, 2-row barley, Fall rye, Winter wheat, Spring wheat	Birdsfoot trefoil Sweetclover Alfalfa Brome grass	Garden beets, Asparagus, Spinach
Moderate	Oats, Yellow mustard	Crested wheatgrass, Intermediate wheatgrass	Tomatoes, Broccoli
4	Meadow fescue, Flax, Canola Corn	Reed canary grass	Cabbage Sweet corn, Potatoes
Low	Timothy, Peas, Field beans	White dutch clover, Alsike clover, Red clover	Carrots, Onions, Strawberries, Peas, Beans

Excess soil salinity causes poor and spotty crop stands, uneven and stunted growth and poor yields. Salinity restricts plant water uptake, interferes with nutrient availability and can impair germination and root growth because of caustic salt effects. Saline areas also tend to have poor soil structure and are subject to water logging, both of which are harmful to crop growth.

Sodium Adsorption Ratio (SAR)

SAR is a less commonly requested analysis that expresses the proportion of exchangeable sodium (Na^+) to exchangeable calcium (Ca^{2+}) and magnesium (Mg^{2+}) ions.

$$\text{Sodium Adsorption Ratio} = \frac{[\text{Na}^+]}{\sqrt{\frac{[\text{Ca}^{2+}] + [\text{Mg}^{2+}]}{2}}}$$

Soils with SAR values at 13 or higher are considered sodic. Crop growth on sodic soils is very poor. Excess sodium causes soil particles to repel each other, preventing the formation of soil aggregates. This results in a very tight soil structure with poor water infiltration and surface crusting.

As stated previously, SAR is not part of standard soil analysis packages for agricultural applications but is routinely done as part of most testing packages for environmental applications. Characterizing the proportion of exchangeable Na can be useful in identifying solonetzic soils.

The sodium hazard of a soil is determined by factoring in the EC and SAR of a soil. This results in a soil being classified as non-saline, non-sodic, saline, sodic or saline-sodic (Table 3.4.6).



Table 3.4.6 Sodium Hazard Classifications Based on Sodium Adsorption Ratio and Electrical Conductivity

Classification	Sodium Adsorption Ratio (SAR)	Electrical Conductivity (dS/m) ¹	Soil pH	Soil Physical Condition
Sodic	> 13	< 4.0	> 8.5	Poor
Saline-Sodic	> 13	> 4.0	< 8.5	Normal
High pH	< 13	< 4.0	> 7.8	Varies
Saline	< 13	> 4.0	< 8.5	Normal

¹ dS/m = mS/cm

Source: Kryzanowski et al. 1988

Cation Exchange Capacity (CEC)

Ion exchange in soils is one of the most important processes influencing crop nutrition. CEC is an estimate of the capacity of soil to hold (or adsorb) positively charged (cation) nutrients. The major soil cations include: calcium (Ca²⁺), magnesium (Mg²⁺), potassium (K⁺), sodium (Na⁺), hydrogen (H⁺) and aluminum (Al³⁺).

The unit of measurement used to commonly express CEC is centimoles of positive charge per kilogram of soil (cmol/kg) and is equivalent to the units formerly used to express CEC; milliequivalents per 100 grams (meq/100g).

How Much is a Mole?

A mole is a quantity used in chemistry to describe 6×10^{23} atoms of a particular element. An element's atomic weight, found in a periodic table of the elements, is the equivalent mass, in grams, of one mole of that substance. For instance, the atomic weight for sodium is 22.989770 grams per mole.

One mole of positive charge refers to the equivalent positive charge on 6×10^{23} monovalent (+1 charge) cations.

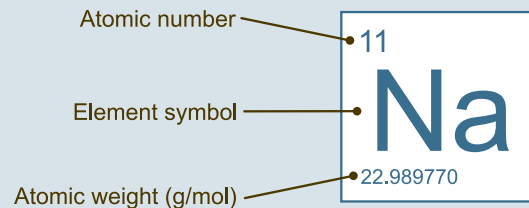

Basing CEC on centimoles (0.01 moles) of positive charge rather than mass (as the older milliequivalent measure did) makes more sense since the mass and charge of the various exchangeable cations in a soil sample changes, while the number of negatively charged exchange sites do not. Cation exchange capacity in cmol/kg remains the same regardless of which ions occupy the exchange sites in a soil sample.

The CEC of a soil is primarily influenced by soil texture and organic matter content. Among the mineral components of soil, clay particles generally have the highest cation exchange capacity followed by silt and sand (Table 3.4.7).

Table 3.4.7 General Relationship Between Soil Texture and Cation Exchange Capacity

Soil Texture	CEC, Normal Ranges (cmol/kg of soil)
Sand	1–5
Fine sandy loam	5–10
Loams and silt loam	5–15
Clay loam	15–30
Clay	30+

Source: Hausenbuiller 1985

Consequently, CEC increases with increased clay content of soils. The type of clay in soil also has an important impact (Table 3.4.8).

Table 3.4.8 Range of Cation Exchange Capacities of Different Types of Clay

Type of Clay	CEC, Normal Ranges (cmol/kg of soil)
Allophane	100–150
Montmorillonite	60–100
Chlorite	20–40
Illite	20–40
Kaolinite	2–16

Source: Hausenbuiller 1985

Organic matter content of soils also has an important influence on the CEC of soils since it has a CEC range of 100 to 300 cmol/kg of soil. There is potential to increase soil CEC by adopting practices and crop rotations that focus on building soil organic matter content.

Estimating CEC from Soil Texture

Direct measurement of CEC is time consuming and is not part of most basic commercial soil analysis packages. Clay and organic matter are the major soil components that contribute to cation exchange; therefore, it is possible to estimate total CEC of a given soil sample based on the percentage of organic matter and clay content and the CEC estimates of each.

sidebar

Most soils in Alberta have clays similar to montmorillonite. The contribution of the clay fraction of soils towards CEC would be in the 60 to 100 cmol/kg range.





Estimating CEC from Soil Texture

A theoretical soil from the Alberta Peace region contains 40 percent clay and two percent organic matter. Using average values of 80 cmol/kg for clay (i.e., montmorillonite; Table 3.4.8) and 200 cmol/kg for organic matter (Tables 3.4.7 and 3.4.8), the estimated CEC for this soil would be:

CEC contribution by clay	= percent clay ÷ 100 x CEC of clay (cmol/kg)
	= 40 ÷ 100 x 80 cmol/kg
	= 32 cmol/kg
CEC contribution by organic matter (OM)	= percent OM ÷ 100 x CEC of OM (cmol/kg)
	= 2 ÷ 100 x 200 cmol/kg
	= 4 cmol/kg
Total CEC	= CEC contribution by clay + CEC contribution by OM
	= 32 cmol/kg + 4 cmol/kg
	= 36 cmol/kg

Base saturation (BS) is a measure of the proportion of the total CEC in soil occupied by Na⁺, K⁺, Ca²⁺, and Mg²⁺ expressed in percent. While there is no ideal percent BS, these values are sometimes used to make recommendations for K, Ca, or Mg amendments to soils. This approach fails to consider the cost and economics of such an application, nor does it take into account excessively high levels of cations.

Soil Organic Matter

Soil organic matter is a measurement of the amount of plant and animal residue in the soil. It has several important implications for soil fertility. Organic matter acts as a revolving nutrient bank account, which releases

crop available nutrients over an extended period. As discussed in the previous section, it also has an important impact, together with clay content, on CEC of the soil. Soil structure, tilth, and water infiltration are also improved by building soil organic matter.

Organic matter content is the distinguishing characteristic of Alberta's soil zones (Figure 3.4.3). The Brown soil zone has the least organic matter having developed beneath a drier, short grass prairie.

Soil Group Map of Alberta

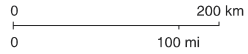

Soil Groups* Natural Subregions**

-  **Brown Chernozemics**
Dry Mixed Grassland
-  **Dark Brown Chernozemics**
Mixed Grassland, Northern Fescue Grassland
-  **Black Chernozemics**
Foothills Fescue, Foothills Parkland, Central Parkland
-  **Dark Gray Chernozemics, Dark Gray - Gray Luvisols**
Dry Mixedwood, Peace River Parkland
-  **Brunisols, Gray Luvisols**
Montane, Subalpine, Alpine
-  **Gray Luvisols**
Western Alberta Uplands
-  **Gray Luvisols, Organics**
Peace River Lowlands, Boreal Highlands, Wetland Mixedwood
-  **Organic Cryosols, Gray Luvisols**
Sub-arctic Northern Alberta Uplands
-  **Brunisols**
Athabasca Plain

*Alberta Soil Survey information.

**Natural Regions and Subregions of Alberta Map, 1994, Alberta Environmental Protection.

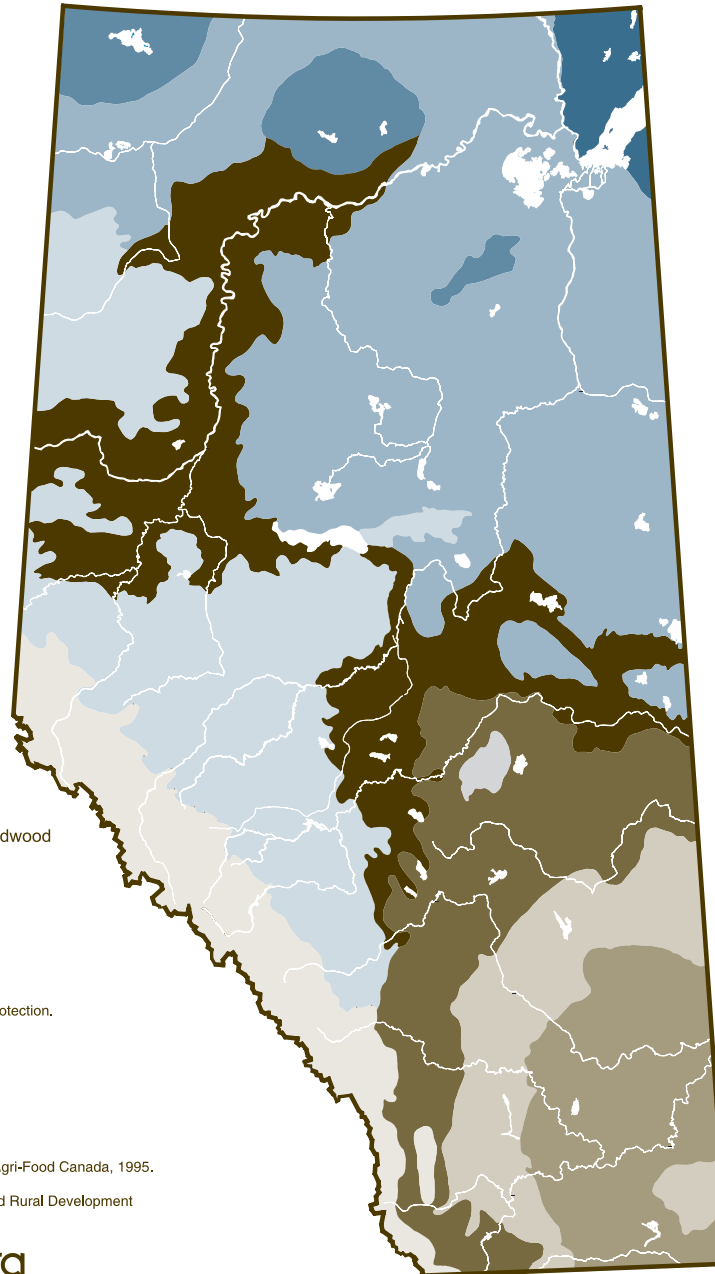

Map compiled by Alberta Land Resource Unit, Research Branch, Agriculture and Agri-Food Canada, 1995.

Produced by Conservation and Development Branch, Alberta Agriculture, Food and Rural Development



From AF

Figure 3.4.3 Alberta's Soil Zones



In contrast, the Black soils developed under a cooler, moister aspen parkland condition resulting in greater production of vegetation and organic matter accumulation. Dark Brown soils developed in the transition zone between the Black and Brown zones and has an intermediate organic matter content.

In parts of the province where trees have been the natural, dominant vegetation, Dark Gray or transitional soils developed. In regions where forest cover dominated for longer periods, Luvisolic (forest) soils developed.

Organic or peat soils are found in low-lying areas throughout the Black, Dark Gray and Gray soil zones. These soils formed where organic residues accumulated at a greater rate than they decomposed. These areas are characterized by waterlogged conditions for much of the year.

Typical soil organic matter levels for Alberta cultivated soils range from two to 10 percent (Table 2.2.2, Chapter 2.2). Specific soil organic matter levels will vary based on management history and landscape position.

The most common laboratory procedure for determining organic matter content is through loss on ignition whereby organic matter is incinerated and only the ash residue remains. Organic matter content is the difference in weight before and after the procedure.

More precise methods are used to determine organic carbon content. This involves correcting total carbon content in a sample for the presences of non-organic carbon (e.g., carbonate). Organic carbon is then used to calculate C to N ratios in the sample.

Estimated Nitrogen Release

Organic matter content is an important source of several key crop nutrients including N. Estimated N release (ENR) is an estimate of the amount of N expected to

become available from organic matter (i.e., mineralized) over the growing season. This estimate takes into account soil organic matter level, soil moisture, and temperature during the growing season. These are the major factors influencing the rate of mineralization from organic matter (refer to the discussion of organic matter in Chapter 2.2).

Typical ENR values for cultivated Alberta soils are provided in Table 3.4.9 and are based on typical soil organic matter levels for each area. Testing labs use ENR when developing N fertilizer recommendations. Consequently, labs may recommend lower N fertilization rates for individual situations where soil analysis ENR is higher than the expected typical range for that soil zone.

Table 3.4.9 Expected ENR Values for Alberta Soil Groups.

Soil Group	Cultivated Soil			
	kg/ha		lb/ac	
	Mean	Range	Mean	Range
Brown	31	30–33	28	27–29
Dark Brown	38	34–47	34	30–42
Black	56	39–81	50	35–72
Dark Gray	45	43–47	40	38–42
Dark Gray (Peace River Region)	41	34–54	37	30–48

Source: AF Field Research, Kryzanowski & Kelbert (2005)

Variability in growing season nitrogen release (mineralization) will exist from field to field depending on management history. Management practices such as direct seeding, rotation with forages or livestock manure application tend to build the more labile (easily decomposable) fraction of soil organic matter. This helps to improve the nutrient supplying power for a specific field situation. The average ENR's in Table 3.4.9 may underestimate the actual field values.

Soil testing labs may also make an adjustment for pulse crop stubble or manure application in the previous one or two years. Depending on yield, residues from previous pulse crops can release between 20 to 30 kg/ha of available N to the following crop. Likewise, release from the organic portion of the manure will increase the soil’s nitrogen supplying power for one or two years after application. This underscores the importance of providing complete information about management and manure application history for a field when submitting samples for analysis.

Soil Texture

Soil texture is the relative proportion of sand, silt and clay in a soil. As discussed in Chapter 2.1, texture directly affects soil water holding capacity, water infiltration rate and indirectly affects soil fertility through CEC.

Soils can be placed into groups (Table 3.4.10) based on textural class, which is determined using a mechanical analysis or the “hand feel” method (Figure 3.1.5, Chapter 3.1). The soil textural triangle is useful for classifying a sample based on the percent sand, silt and clay (Figure 3.1.4, Chapter 3.1).



Table 3.4.10 Soil Texture Group Based on Soil Texture Class

Soil Texture Classes	Soil Texture Group				
	Very Coarse	Coarse	Medium	Fine	Very Fine
	Sand Loamy Sand	Sandy Loam Fine Sandy Loam	Loam Sandy Clay Loam Sandy Clay Clay Loam	Silt Loam Silty Clay Loam Silt	Clay Silty Clay Heavy Clay

Source: Kryzanowski et al. 1988

Table 3.4.11 Classifications for Organic Soils Based on Organic Matter Content

Classification	Organic Matter Content (%)
Muck	30–45
Peaty Muck	45–65
Mucky Peat	65–85
Peat	85–100

Source: Landva et al. 1983

Available Soil Moisture

The amount of soil moisture available at the time of planting is an important consideration when making cropping and fertility decisions. Crop yield potential is directly related to stored soil water and growing season rainfall or irrigation. Low moisture availability will limit crop yield and reduce nutrient requirements. Soils are characterized as being dry, average or wet according to the depth of moist soil and texture class (Table 3.4.12).



Table 3.4.12 Qualitative Interpretation of Available Soil Moisture

Soil Texture Group	Depth of Moist Soil (cm)		
	Dry	Average	Wet
Very Coarse	30–60	60–120	120+
Coarse	30–50	50–100	100+
Medium	15–30	30–60	60+
Fine & Very Fine	15–30	30–60	60+

Adapted from Brady and Buckman 1969

Determining Soil Available Moisture

Soil moisture can be assessed at the same time that fields are being soil sampled. The same rules regarding representative sampling apply to assessing soil moisture. Areas such as depressions, slopes, and knolls can be assessed separately for site-specific crop planning. Sample a minimum of 15 to 20 sites per field and record the average depth of moist soil. Spring sampling may require more sites within a field because of increased variability caused by snow trapping, snow drifting, water runoff, moisture migration within the soil and variations in ground frost, etc.

Soil moisture can be determined by:

- using the “feel test” (Figure 3.1.5, Chapter 3.1)
- subjective visual evaluation
- measuring the depth of moist soil in a collected soil core
- brown soil probe (Figure 3.4.4)

Using the Brown Soil Probe to Determine Soil Moisture

To assess soil moisture depth, vigorously push the probe into the soil in one motion without turning and while applying weight to the handle. The probe will penetrate the soil and will stop when dry soil is reached. Record the depth into the soil that the probe was able to penetrate. Refer to Table 3.4.12 to determine available soil moisture. Stones, frozen soil or a dry surface layer may stop the probe as well, but these are easily detected.

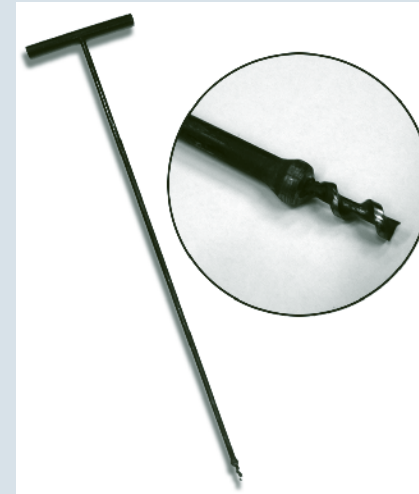

Photo courtesy Crystal Korth and Len Kryzanowski, AF

Figure 3.4.4 Brown Soil Probe

The probe has a short section of a wood drill-bit welded to its end. When the probe is twisted clockwise, a small sample of soil can be obtained. This soil sample can be used to determine texture class and moisture by feel (see method in Chapter 3.1). To construct a soil moisture probe, weld a three-quarter inch steel ball on one end of a one metre long half-inch rod and weld a handle on the other end.

Fertilizer Recommendations

Fertilizer recommendations are usually based on yield response curves or yield expectations for a crop based on soil moisture and growing season precipitation. Recommendations may vary considerably between labs because of different analytical methods, yield response models, yield predictions, expected precipitation and fertilizer use efficiency.

A good soil sample and an accurate soil analysis interpretation are not the only considerations for good yields and maximum profit in crop production. Even if the recommended fertilizer rate is applied, other factors may override the fertilizer effects by limiting crop yield potential. These factors include:

- soil type and stored soil water at time of planting.
- pest control.
- irrigation water quality and management.
- other agronomic and cropping system factors (e.g., seeding date, rate, planting system, fertilizer application method, crop rotation, variety selection, etc.).

Many of these factors are under direct control of the producer; therefore, a favourable fertilizer response is usually related to crop management. Critically examine fertilizer recommendations, yield predictions and growing season precipitation to ensure they are realistic for the area.

Figure 3.4.5 illustrates how all of these considerations are assembled into a decision-making model used to develop a fertilizer recommendation. This model is used by the AFFIRM software package. For more information, see Chapter 7.2.

tip



If a recommendation on a lab analysis does not appear reasonable, request an explanation from the testing lab, seek advice from a qualified agronomic consultant (e.g., Certified Crop Advisor), or contact AF's Ag-Information Centre, toll-free at 310-FARM (3276).

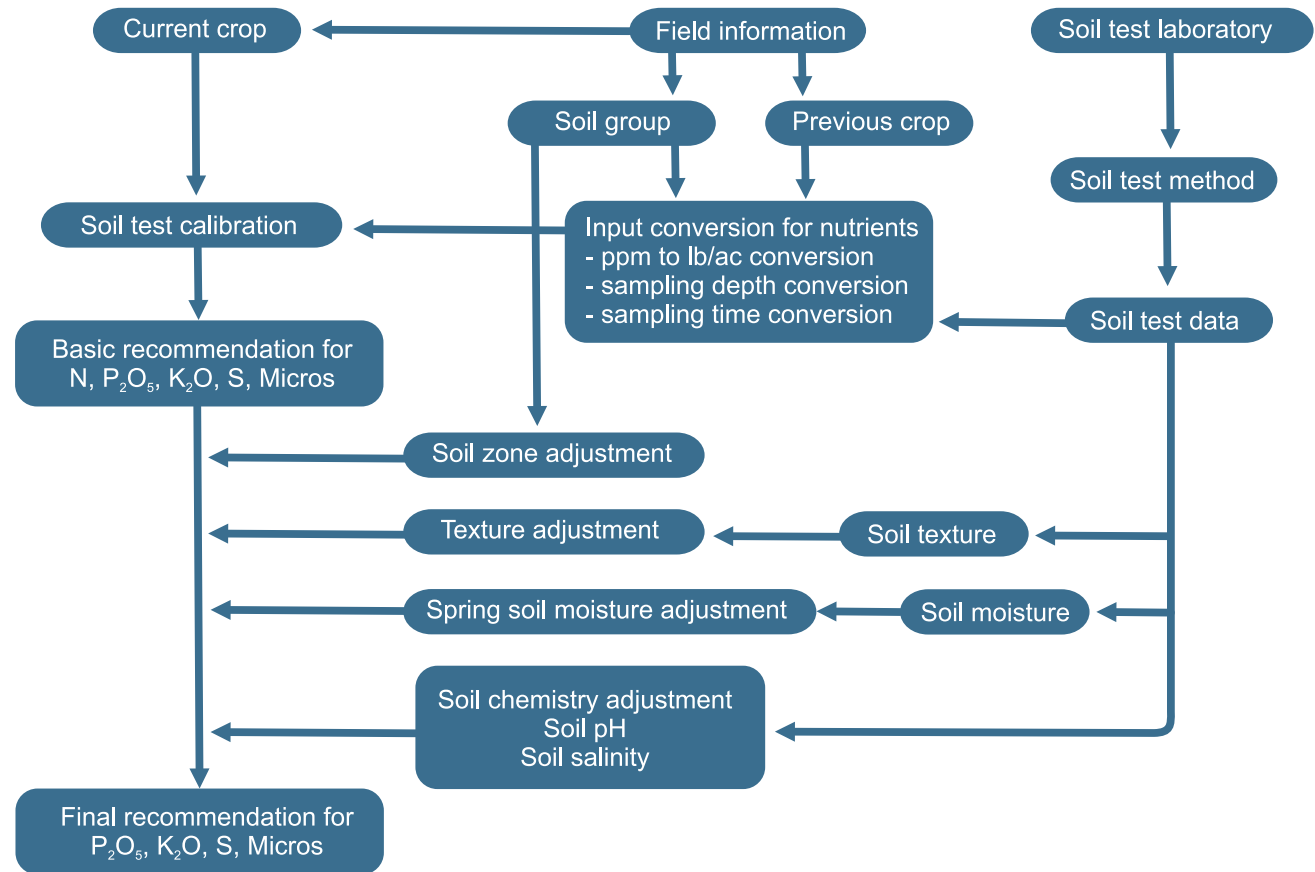

Figure 3.4.5 Decision Making Model Used by AFFIRM to Develop Fertilizer Recommendations

➔ summary

- Key information in a soil analysis report includes: client information, sample **identification, date sample was received** and processed, nutrient analyses, soil quality parameters (e.g., pH, organic matter, EC) and fertilizer recommendations.
- Soils with pH near 7.0 are considered neutral. Extremes in pH will affect crop productivity. Fertilizer recommendations are adjusted for reduced yields.
- High soil salinity causes poor and spotty crop stands, uneven and stunted growth, and poor yields. Fertilizer recommendations are adjusted for reduced yields.
- Cation exchange capacity indicates the ability of a soil to retain nutrients in the root zone. It can be estimated from the clay and organic matter content of soil.
- Organic matter acts as a revolving nutrient bank account by releasing crop available nutrients over an extended period.
- Soil texture directly affects soil water **holding capacity and water infiltration rate**, and indirectly affects soil fertility through CEC.
- Crop yield potential is directly related to stored soil water plus growing season rainfall or irrigation.
- Fertilizer recommendations may vary considerably among labs because of different analytical methods, yield response models, yield predictions, expected **precipitation and fertilizer use efficiency**.

Chapter 4.1

Estimating Manure Inventory

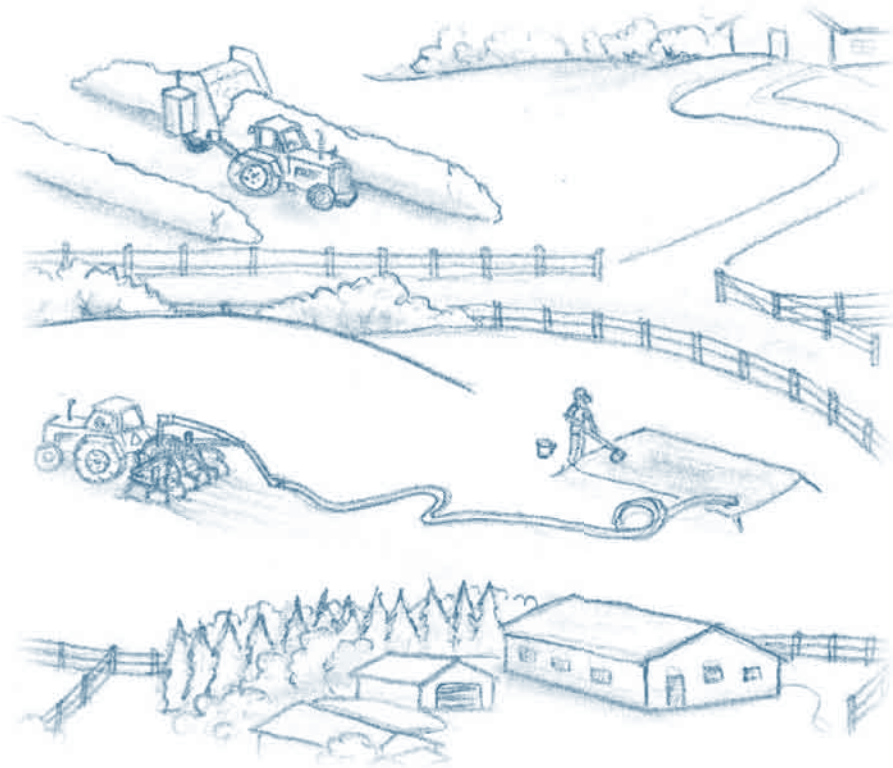

➔ learning objectives

- Briefly explain the importance of determining manure weight or volume.
- Estimate the weight of solid manure in a pile.
- Estimate the volume of liquid manure in storage facilities.
- Describe the optimal time to determine manure inventory.



Important Terms

Table 4.1.1 Key Terms and Definitions

Term	Definition
Agitation	The stirring up or mixing, in this context, liquid manure in a storage facility.
Circumference	The outer boundary of a circular area.
Cosine	The ratio of the length of the side adjacent to an acute angle of a right triangle to the length of the hypotenuse. Abbreviation: cos.
Diameter	A straight line passing through the center of a circle or sphere and meeting the circumference or surface at each end.
Freeboard	The distance from the top of the manure storage to the top of the manure.
Hypotenuse	The side of a right triangle opposite the right angle.
Perpendicular	Meeting a given line or surface at a right angle.
Pi (π)	The mathematical constant π is a transcendental real number, approximately equal to 3.14159, which is the ratio of a circle's circumference to its diameter.
Radius	A straight line extending from the center of a circle or sphere to the circumference or surface, respectively. The radius of a circle is half the diameter.
Right Angle	An angle that measures 90 degrees.
Windrow	A row or line of any material, but in this publication it refers to stored manure.

The weight or volume of available manure should be determined prior to land application. There are at least three reasons why getting an accurate estimate of manure volume or weight is important:

- The weight of available manure, together with nutrient content, can be used to estimate the required land base for manure utilization.
- To determine if a producer is subject to additional requirements under AOPA (e.g., if more than 500 tonnes of manure is handled).
- To estimate the time required to apply manure.

Weighing manure is the most accurate method for determining the quantity of manure applied. Physically weighing manure may not be practical or safe, in which case manure inventory must be estimated. There are three options for estimating manure inventory:

- Standard estimates or “book values” for average manure production for different livestock.
- Historical manure application records, or capacity indicators in storage facilities.
- Calculated estimates of pile weight or volume contained in a storage facility.

Standard estimates or “book values” are useful when estimating storage needs, but are of limited value for nutrient management planning. Standard values may not reflect the actual volume or weight of manure produced because of factors such as precipitation, feeding and bedding practices and water conservation practices.

Operations may have manure application records documenting the volume of manure applied in the past (e.g., number of loads hauled). Provided the operation has not changed in size, management or type of livestock this estimate can be reliable enough for nutrient management

planning. In addition, existing manure storage facilities may be equipped with capacity markers that provide easy estimates of volume present.

The weight or volume of manure in a storage facility can be estimated using direct measurements and calculations. This method can be used in the absence of historical manure application records, and is more operation specific than using standard values. The rest of this chapter will focus on how to measure and calculate volume and weight of stored solid and liquid manure.

Estimating the Weight of Solid Manure

Nutrient content of solid manure is usually expressed as a percentage, or in weight of nutrient per unit weight of manure (e.g., kilograms per tonne). Weight can be estimated by multiplying the volume by the bulk density of the manure. To estimate the weight of solid manure:

1. Determine the shape of the manure pile.
2. Obtain dimensions of the pile.

3. Calculate volume.
4. Measure density of material in the pile.
5. Calculate weight.

Determine Shape of a Pile

Identifying the shape of a manure pile is necessary to determine the dimensions and calculations needed to estimate its volume. The volume of any shape is its area multiplied by its depth, although for some shapes these dimensions are not always easy to identify. Solid manure piles are often irregular in shape, but can be visualized as an assembly of several smaller, simple geometric shapes (Figure 4.1.1).

Calculating and adding the individual volumes of these smaller shapes will give the total volume of the pile. This process may require several calculations, but will yield a more accurate volume estimate for irregular piles. To calculate the volume of various shapes, refer to the shapes and associated equations provided in Figure 4.1.2.

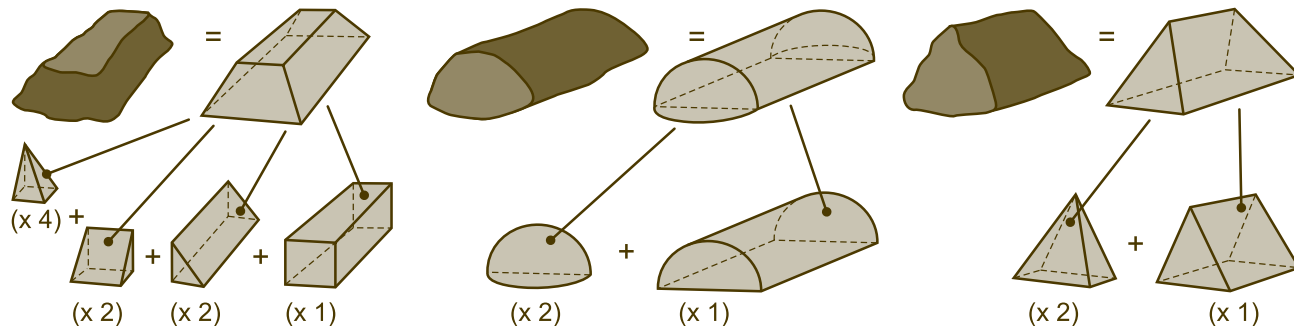
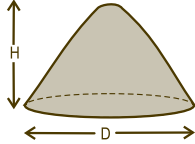
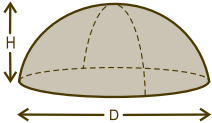
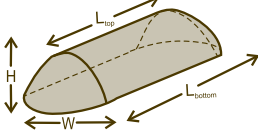
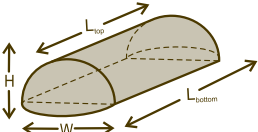

Figure 4.1.1 Complex Shapes Broken into Simple Shapes

Pile Type	Required Dimensions	Calculations to Estimate Volume (Approx.)
<p>Peaked Pile: Closely resembles a cone.</p> 	<p>Diameter of pile (D_{pile}) Height of pile (H_{pile})</p>	<p>Diameter of a pile: $D_{pile} = \text{circumference} \div \pi$ Volume of a peaked pile: $V_{pile} = 0.262 \times D_{pile} \times D_{pile} \times H_{pile}$</p>
<p>Rounded Pile: Closely resembles a partial sphere.</p> 	<p>Diameter of pile (D_{pile}) Height of pile (H_{pile})</p>	<p>Diameter of a pile: $D_{pile} = \text{circumference} \div \pi$ Volume of a rounded pile: $V_{pile} = 0.131 \times H_{pile} \times [(4 \times H_{pile} \times H_{pile}) + (3 \times D_{pile} \times D_{pile})]$</p>
<p>Peaked Windrow: Can be visualized as a combination of a triangular prism and a cone.</p> 	<p>Length of windrow along the bottom (L_{bottom}) Estimated length of windrow along the top (L_{top}) Width of windrow ($W_{windrow}$) Height of windrow ($H_{windrow}$)</p>	<p>Volume of a triangular prism: $V_{prism} = H_{windrow} \times W_{windrow} \times L \div 2$ Diameter of a cone: $D_{cone} = (L_{bottom} - L_{top} + W_{windrow}) \div 2$ Volume of a cone: $V_{cone} = 0.262 \times D_{cone} \times D_{cone} \times H_{windrow}$ Total windrow volume: $V_{windrow} = V_{prism} + V_{cone}$</p>
<p>Rounded Windrow: Can be visualized as a combination of a partial cylindrical prism and a partial sphere.</p> 	<p>Length of windrow along the bottom (L_{bottom}) Estimated length of windrow along the top (L_{top}) Width of windrow ($W_{windrow}$) Height of windrow ($H_{windrow}$)</p>	<p>Volume of a partial cylinder: $V_{cylinder} = 0.7 \times H_{windrow} \times L_{bottom} \times W_{windrow}$ Diameter of a sphere: $D_{sphere} = (L_{bottom} - L_{top} + W_{windrow}) \div 2$ Volume of a partial sphere: $V_{sphere} = 0.131 \times H_{windrow} \times [(4 \times H_{windrow} \times H_{windrow}) + (3 \times D_{sphere} \times D_{sphere})]$ Total windrow volume: $V_{windrow} = V_{cylinder} + V_{sphere}$</p>

Adapted from Brodie, 1990

Figure 4.1.2 Equations for Calculating Volume of Various Shapes

Obtaining Dimensions of a Pile

Some pile dimensions can be measured directly using simple devices such as a tape measure. Direct measurement of other dimensions, such as height and diameter, may not be practical or safe. These must be estimated using indirect means.

» Estimating the Height of a Pile

Simple mathematical relationships between the lengths of the sides of a right triangle (i.e., triangle with a 90 degree angle) can be used to estimate the height of a pile. Lean a piece of wood (e.g., a 2 × 4) of known length against the pile, with one end on the crest of the pile and the other end on the ground (Figure 4.1.3).

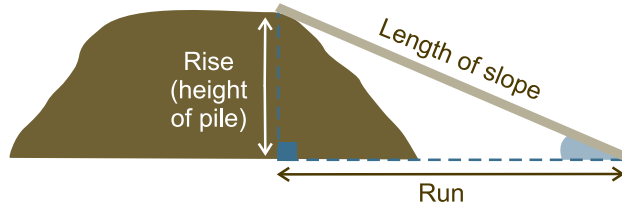

Figure 4.1.3 Using a Board to Estimate Height of a Pile (the “leaning 2x4” method)

Select an arbitrary point somewhere along the length of the board. Using a tape measure take the following measurements from this arbitrary point:

- The vertical distance from the point to the ground directly below.
- The distance from the point to the edge of the board resting on the ground.

The ratio between these two measurements is identical to that between the height of the pile and the total length of the board. Multiplying the length of the board by this ratio will yield the height of the pile.

Key Mathematical Relationship of a Right Angle Triangle

$$\text{Tangent of angle} = \frac{\text{Length of opposite side}}{\text{Length of adjacent side}}$$

$$\text{Cosine of angle} = \frac{\text{Length of adjacent side}}{\text{Length of hypotenuse}}$$

$$\text{Sine of angle} = \frac{\text{Length of opposite side}}{\text{Length of hypotenuse}}$$

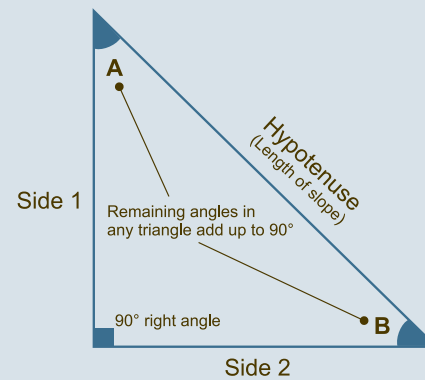

$$\left(\text{Length of Hypotenuse} \right)^2 = \left(\text{Length of Side 1} \right)^2 + \left(\text{Length of Side 2} \right)^2$$

Figure 4.1.4 Labeled Right Angle Triangle

The graphic (Figure 4.1.4) represents a right angle triangle with the sides labeled in terms of angle ‘A’. Any of the sides or angles of a right-angled triangle can be solved if the measurement for at least one angle (in addition to the 90 degree angle) and one side are known. This mathematical principle will be used to calculate the height of manure.



The Leaning 2 x 4 Method Used to Estimate Height of a Pile

A 4.9 m (16 ft) board is leaned against a solid pile of cattle manure. An arbitrary point is selected on the board that is 0.9 m above the surface of the ground and 2.0 m from the end of the board (Figure 4.1.5).

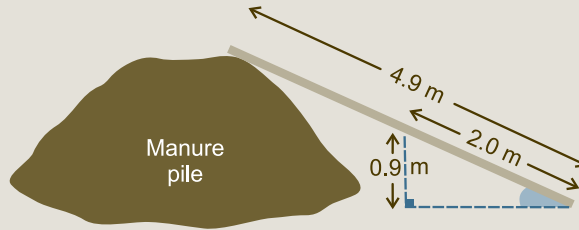

Figure 4.1.5 Solid Manure Pile

The ratio between these measurements is:

$$\begin{aligned} \text{Rise: Slope Length Ratio} &= 0.9 \text{ m} \div 2.0 \text{ m} \\ &= 0.449 \end{aligned}$$

Since it can be assumed that this ratio will be the same between the height of the pile and the total length of the board, the height of the pile is:

$$\begin{aligned} \text{Height of the pile (m)} &= \text{length of the board (m)} \\ &\quad \times \text{rise:slope length ratio} \\ &= 4.9 \text{ m} \times 0.449 \\ &= 2.2 \text{ m is the height of the pile} \end{aligned}$$

» **Estimating Diameter of a Pile**

For round piles, measure the circumference around the base of the pile. Circumference and diameter of a circle are directly proportional according to the following relationship:

$$\text{Diameter} = \text{Circumference} \div \pi$$

For windrows with rounded contours, measure the total length of the pile along the ground and then estimate the length along the top of the pile; this should be shorter. The difference between these two measurements is an acceptable estimate of the diameter of the partial sphere formed by the two rounded ends of the pile (Figure 4.1.2). In theory, the width of the pile is also an acceptable estimate of diameter. Since there can be considerable difference between these measurements, the diameter that is used for the volume calculation is the average of these two measurements:

$$\text{Diameter} = (\text{Windrow Bottom Length} - \text{Windrow Top Length} + \text{Windrow Width}) \div 2$$



Estimating the Diameter of a Pile

A rounded pile of manure has a measured circumference of approximately 22 m.

$\pi = 3.1416$. The diameter of this pile is:

$$\begin{aligned} \text{Diameter (m)} &= \text{Circumference} \div \pi \\ &= 22 \text{ m} \div 3.1416 \\ &= 7.0 \text{ m is the diameter of the pile} \end{aligned}$$

Calculate Volume of a Pile

Once all necessary dimensions have been measured (or calculated) (i.e., height, diameter), the next step is to calculate volume using the stepwise calculations in the rightmost column of Figure 4.1.2.



Calculating the Volume of a Rounded Windrow

A pile of manure resembles a rounded windrow (Figure 4.1.2). The rounded manure windrow has the following dimensions (top length = 24 m, bottom length 31 m, width 3.4 m and height 2.6 m (Figure 4.1.6).

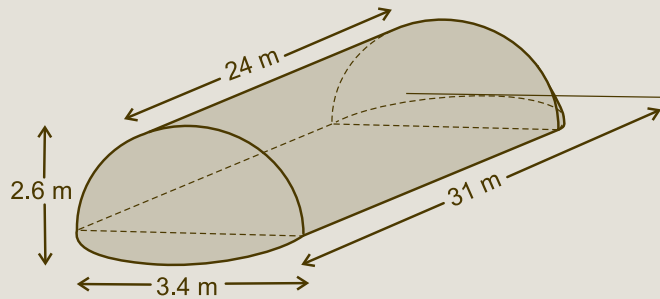

Figure 4.1.6 Windrow of Cattle Manure with Estimated Dimensions

The estimated volume of this pile is:

$$\begin{aligned}
 \text{Volume of partial cylinder (V}_{\text{cylinder}}) &= 0.785 \times H_{\text{windrow}} \times L_{\text{top}} \times W_{\text{windrow}} \\
 &= 0.785 \times 2.6 \text{ m} \times 24 \text{ m} \times 3.4 \text{ m} \\
 &= 166.5 \text{ m}^3 \text{ is the volume of the partial cylinder}
 \end{aligned}$$

$$\begin{aligned}
 \text{Diameter of the partial sphere (D}_{\text{sphere}}) &= (L_{\text{bottom}} - L_{\text{top}} + W_{\text{windrow}}) \div 2 \\
 &= (31 \text{ m} - 24 \text{ m} + 3.4 \text{ m}) \div 2 \\
 &= 5.2 \text{ m is the diameter of the partial sphere}
 \end{aligned}$$

$$\begin{aligned}
 \text{Volume of partial sphere (V}_{\text{sphere}}) &= 0.131 \times H_{\text{windrow}} \times [(4 \times H_{\text{windrow}} \times H_{\text{windrow}}) + (3 \times D \times D)] \\
 &= 0.131 \times 2.6 \text{ m} \times [(4 \times 2.6 \times 2.6) + (3 \times 5.2 \times 5.2)] \\
 &= 0.3406 \text{ m} \times [(4 \times 6.76 \text{ m}^2) + (3 \times 27.04 \text{ m}^2)] \\
 &= 0.3406 \text{ m} \times [27.04 \text{ m}^2 + 81.12 \text{ m}^2] \\
 &= 0.3406 \text{ m} \times 108.16 \text{ m}^2 \\
 &= 36.8 \text{ m}^3 \text{ is the volume of the partial sphere}
 \end{aligned}$$

The volume of the pile is:

$$\begin{aligned}
 \text{Total windrow volume (V}_{\text{windrow}}) &= V_{\text{cylinder}} + V_{\text{sphere}} \\
 &= 166.5 \text{ m}^3 + 36.8 \text{ m}^3 \\
 &= 203.3 \text{ m}^3 \text{ is the total volume of the rounded windrow}
 \end{aligned}$$

tip



Due to exposure to the elements, the surface density of a pile is often different than the interior density. If the outer weathered layer is relatively thin (i.e., less than 15 cm), scrape off the surface of the pile until moist material is reached. If the pile has a thick weathered layer, use a core-sampling device such as a manure sampling probe (Chapter 4.2).

tip



Using “book” values for the bulk density of a manure pile, rather than determining the actual density, can lead to large errors in estimated total weight.

Measure Bulk Density of a Pile

Manure nutrients are applied on a weight basis. As a result, the volume of manure in a pile must be converted to weight by using the bulk density of the material. The procedure for determining bulk density of solid manure, poultry litter or compost is simple:

1. Measure and record the weight and volume of an empty container. Conversion factors for volume and weight measurements are provided in Table 4.1.3 and 4.1.4.
2. Sample the pile, being sure that the samples reflect the composition of the pile (i.e., proportions of bedding and manure). Take samples perpendicular to the face of the pile, to get a better representation of the layering profile within the pile. Try to go as deep as possible, at least 50 cm (Figure 4.1.7).
3. Fill the container without excessively packing or compacting the material, trying to achieve a similar consistency as in the pile. Measure and record the weight of the filled container. Calculate bulk density by dividing the weight by the volume.
4. Repeat this procedure 10 to 20 times (depending on the variability and size of the pile) from various sites on the pile. Large, variable piles will require a greater number of samples. Determine the average bulk density for the pile from the samples collected.

Table 4.1.3 Factors for Converting Between Units of Volume

Start Units	Multiply start units by factors in the appropriate column to get:					
	ft ³	yd ³	m ³	L	US gal	Imp gal
Cubic feet (ft ³)		0.0370	0.0283	28.32	7.481	6.229
Cubic yards (yd ³)	27.0		0.7646	764.6	202.0	168.2
Cubic metres (m ³)	35.31	1.308		1000	264.2	220.0
Litres (L)	0.0353	0.0013	0.001		0.2642	0.2200
US gallons (US gal)	0.1337	0.0050	0.0038	3.785		0.8327
Imperial gallons (Imp gal)	0.1605	0.0059	0.0045	4.546	1.201	

Table 4.1.4 Converting Between Units of Weight or Mass

Start Units:	Multiply start units by factors in the appropriate column to get:			
	lb	tn	kg	t
Pounds (lb)		0.00050	0.45359	0.00045
Short tons (tn)	2000.0		907.18	0.90718
Kilograms (kg)	2.2046	0.00110		0.00100
Tonnes (t)	2,204.6	1.1023	1000.0	

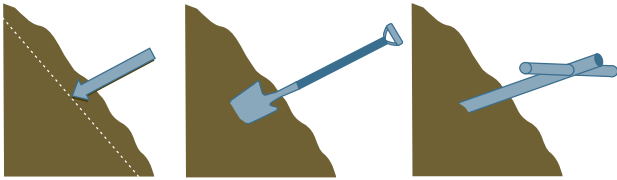

Figure 4.1.7 Sampling Perpendicular to the Pile Surface



Calculating Bulk Density

A 20 L (5 gal) pail filled with material from a manure pile weighs approximately 19.48 kg (42.95 lbs). The bulk density of the material in the pail is:

Pail volume (m³)

$$\begin{aligned} &= \text{pail volume (L)} \times \text{conversion factor (Table 4.1.3)} \\ &= 20 \text{ L} \times 0.001 \text{ m}^3/\text{L} \\ &= 0.02 \text{ m}^3 \end{aligned}$$

Bulk density (kg/m³)

$$\begin{aligned} &= \text{weight} \div \text{pail volume} \\ &= 19.48 \text{ kg} \div 0.02 \text{ m}^3 \\ &= 974 \text{ kg/m}^3 \text{ is the approximate bulk density of the material in the pail} \end{aligned}$$

» Determining Bulk Density of Poultry Litter in the Barn

For most broiler operations, it may be just as easy to determine bulk density of the litter before it is removed from the barn, particularly if it is to be spread immediately. This is convenient if manure is sampled for analysis at the same time. Bulk density can be determined using the same procedure outlined above with two differences:

- Instead of sampling from different points on the pile, sample litter from different points in the barn.
- Scraping off the surface layer of the pack before sampling is not required.

Calculate Weight of a Pile

Total weight of solid manure in a pile or windrow is calculated by multiplying bulk density of the material by the estimated volume of the pile:

$$\text{Total weight of pile (t)} = \text{Bulk density, kg/m}^3 \times \text{Volume, m}^3 \div 1000 \text{ kg/t}$$



Calculating the Weight of a Pile of Manure

After taking several samples at different points of the pile, the average weight of material in a 20 L (5 gal) pail is estimated to be 19.48 kg. The estimated density is 974 kg/m³. Putting this together with a volume of 203 m³:

Total weight of pile (t)

$$\begin{aligned} &= (\text{Bulk density, kg/m}^3 \times \text{Volume, m}^3) \div 1000 \text{ kg/t} \\ &= (975 \text{ kg/m}^3 \times 203 \text{ m}^3) \div 1000 \text{ kg/t} \\ &= 197,925 \text{ kg} \div 1000 \text{ kg/t} \\ &= 198 \text{ t is the total weight of the pile of manure} \end{aligned}$$

tip



Bulk density can be expressed as kg/m³ or kg/L and volume as m³ or L. The numerical result from the weight calculation will be the same.





Estimating the Volume of Liquid Manure in Storage

Many liquid manure storage facilities in Alberta are constructed in a cylindrical or tapered prism shape (Figure 4.1.8). The tapered prism shape is commonly seen in earthen manure storage facilities and the cylindrical shape can be commonly found in aboveground (typically glass lined steel) and below grade (concrete lined) storages.

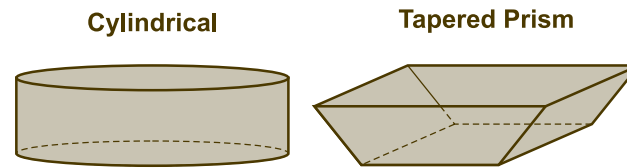

Figure 4.1.8 Cylindrical and Tapered Prism Liquid Manure Storage Facilities.

In contrast to solid manure, nutrient content of liquid manure is expressed as weight of nutrient per unit volume (e.g., kg per 1000 L). The strategy for estimating manure volume involves subtracting the volume not filled with manure from the maximum capacity of the structure. Calculate the volume of liquid manure in storage by:

- Estimating or determining dimensions of the storage facility.
- Inserting the dimension values (i.e., height, diameter) into the appropriate equation to calculate volume (Figure 4.1.9 and Figure 4.1.10).

Hazards Associated with Liquid Manure Storage Facilities

Liquid manure storage facilities present several hazards to personal safety. Gases such as hydrogen sulphide (H_2S) and ammonia (NH_3) can cause symptoms ranging from headaches and eye irritation to death depending on length of exposure and gas concentration.

There is also the risk of falling into the storage. Never work around a liquid manure storage facility alone. Use a tether or harness connected to a solidly fixed object (e.g., tractor, vehicle or sturdy fencepost) to minimize the risk of falling into the storage.

Estimating Manure Volume in Cylindrical Storage Facilities

To calculate the volume of a cylindrical storage facility the following dimensions are needed (Figure 4.1.9):

- Height of the manure in storage.
- Diameter of the storage facility.

To calculate the height of the manure, subtract the freeboard from the total height of the storage facility. Next, use the circumference of the facility to calculate the diameter (Figure 4.1.10).

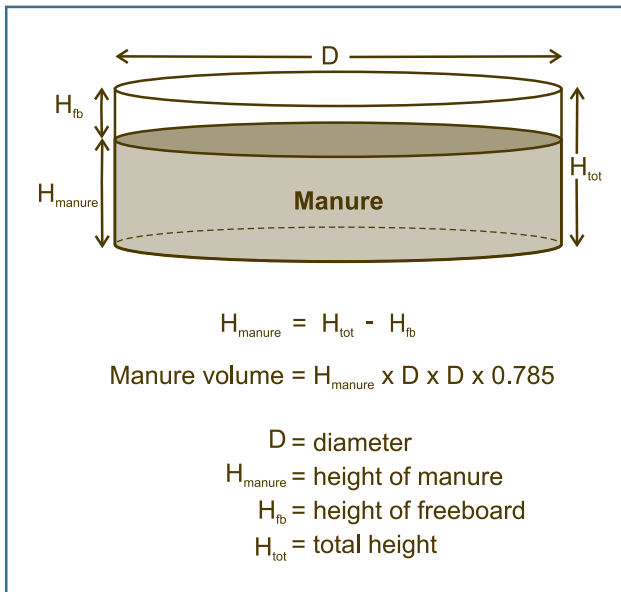

Figure 4.1.9 Dimensions and Calculations for Estimating the Volume in a Cylindrical Storage Facility

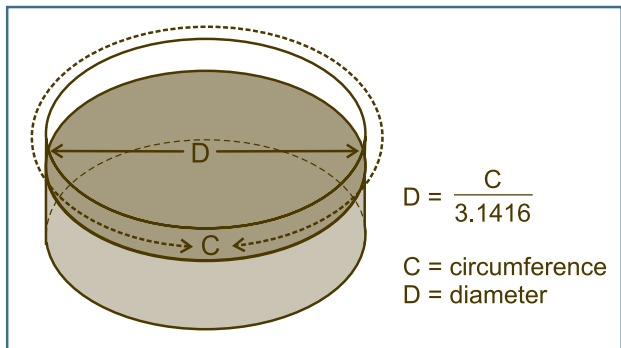

Figure 4.1.10 Relationship between the Circumference and Diameter of a Circle



Calculating Diameter of a Cylindrical Storage Facility Using Circumference

The circumference of a below grade, concrete cylindrical storage facility is measured as 124 m. Based on this information, the diameter of this manure storage is:

$$\text{Diameter} = \text{Circumference} \div \pi$$

Diameter of a cylindrical storage facility (m)

$$= 124 \text{ m} \div 3.1416$$

= 39.5 m is the diameter of the cylindrical storage facility

Knowing the facility dimensions, volume can be estimated using the following calculation:

$$\text{Manure volume} = \text{height of manure} \times (\text{diameter}^2) \times 0.785$$

more info



For more information on managing hazardous gases found in liquid

manure storage facilities, check out these factsheets, which can be obtained from the publications office of AF by calling toll free 1-800-292-5697 or on Ropin' the Web.

- AF. 1998. Ammonia Emissions and Safety. Agdex 086-6
- AF. 1998. Hydrogen Sulfide Emissions and Safety. Agdex 086-2
- Ontario Ministry of Agriculture, Food and Rural Affairs. 2004. Hazardous Gases. Agdex 721. www.omafra.gov.on.ca/english/engineer/facts/04-087.htm



Calculating Volume of Manure in a Cylindrical Manure Storage Facility

The total height (h_{tot}) of a cylindrical liquid manure storage facility is 4.75 m. The diameter (d) is 40 m. The current freeboard (h_{fb}) is 1.9 m. The estimated volume of manure currently in the facility is:

$$\begin{aligned}\text{Height of Manure } (h_{\text{manure}}) &= \text{total height } (h_{\text{tot}}) - \text{height of freeboard } (h_{\text{fb}}) \\ &= 4.75 \text{ m} - 1.9 \text{ m} \\ &= 2.85 \text{ m is the approximate height of the manure}\end{aligned}$$

$$\begin{aligned}\text{Manure volume } (\text{m}^3) &= \text{height of manure } (h_{\text{manure}}) \times (\text{diameter}^2) \times 0.785 \\ &= 2.85 \text{ m} \times (40 \text{ m})^2 \times 0.785 \\ &= 3,579.6 \text{ m}^3 \text{ is the approximate volume of the manure}\end{aligned}$$

$$\begin{aligned}\text{Converting cubic meters to litres} &= 3,579.6 \text{ m}^3 \times 1000 \text{ L/m}^3 \\ &= 3,579,600 \text{ L is the approximate volume of the manure}\end{aligned}$$

Estimating Volume in Tapered Prism Storage Facilities

To calculate the volume of a tapered prism storage facility the following dimensions are needed:

- Top length and width
- Slope of storage facility walls
- Length of sloped wall of the facility
- Length of freeboard

These measurements are used to estimate the dimensions required to calculate volume of manure in the facility (Figure 4.1.11).

- Estimating height (depth) of manure in a storage facility
- Width and length of the facility base
- Width and length of the manure surface in storage

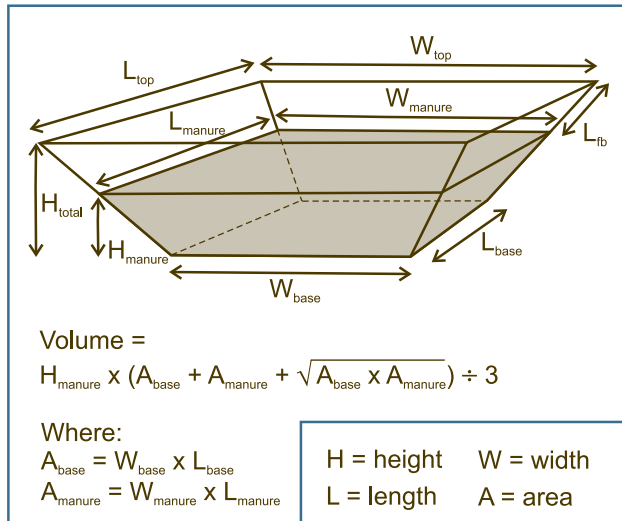

Figure 4.1.11 Estimating Volume in a Tapered Prism Storage Facility.

» Top Length and Width

Measure the length and width of the top of the storage facility by marking the corners with wooden stakes and using a tape measure.

» Slope of Storage Facility Walls

Slope on the wall of the storage facility (expressed in degrees) is used to estimate base length and width and height (depth) of manure in the facility. It is only necessary to determine the slope on one wall because all walls of professionally designed facilities should be the same. If this is not the case, measurements will need to be collected for each wall.

To calculate the slope, the following materials are needed:

- minimum 2 m length of un-warped lumber (e.g., 2 × 4)
- carpenter's level
- pencil
- protractor from a school geometry set

tip



The ideal time to measure length is when a facility is empty; however, this is not always possible or practical. Verify measurements made when the facility was full once the facility has been emptied out.

tip



Before taking measurements, consult the producer, the contractor who built the facility, or any facility design documents to see if the storage facility dimensions are available. This can save considerable time and will eliminate the element of personal risk associated with these facilities.

Key Mathematical Relationship of a Right Angle Triangle

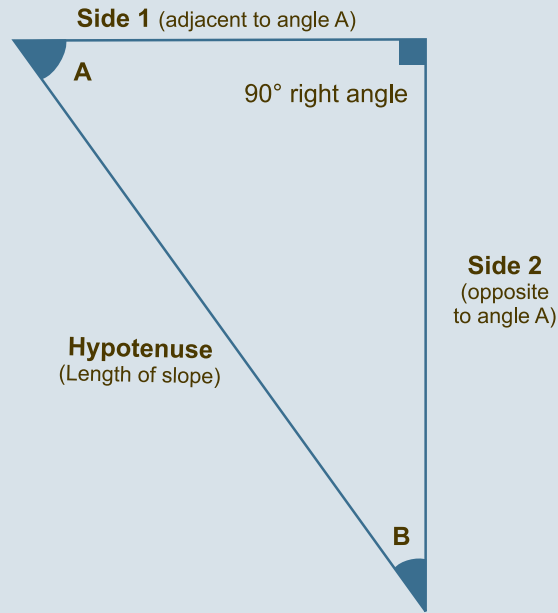

Figure 4.1.12 Labeled Right Angle Triangle (rotate 90 degrees)

The graphic (Figure 4.1.12) represents a right angle triangle with the sides labeled in terms of angle 'A'. Any of the sides or angles of a right-angled triangle can be solved if the measurement for at least one angle (in addition to the 90 degree angle) and one side are known. This mathematical principle will be used to calculate the height (depth) of manure in a tapered prism storage facility.

Rest the board on the slope of the storage wall with at least 30 cm (1 ft) projecting above the top of the storage wall. Place the board on its narrow edge such that the broad face is visible in side profile (Figure 4.1.13A).

Place the carpenter's level against the face of the board above the top of the storage wall (Figure 4.1.13B). Draw a level horizontal line along the face, using the carpenter's level as a guide. Use the protractor to measure the angle formed between the line and the bottom edge of the board that rested on the wall of the manure storage (Figure 4.1.13C). This will be referred to as the measured slope angle of the facility wall.

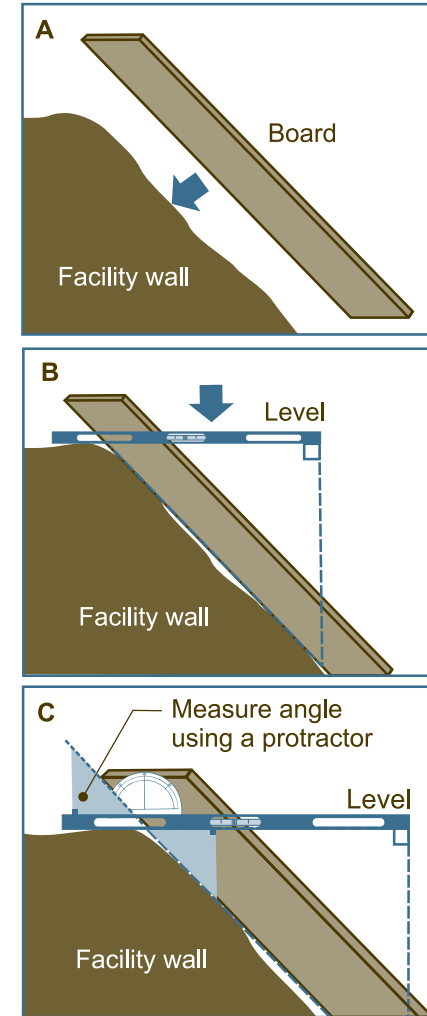

Figure 4.1.13 Estimating Slope on the Wall of an Earthen Manure Storage Facility

» Length of Sloped Wall of a Facility

Safe and practical measurement of the length of sloped wall in a storage facility is difficult, particularly when the facility is full. The preferred option is to consult plans or design schematics for the facility. If these are unavailable, the alternative is to make a direct measurement once the facility has been emptied. When using this strategy take special care to minimize risk of damage to the liner, particularly if the liner is synthetic. Damage to the liner can result in leaks and can be costly to repair. This measurement will be used to estimate the height (depth) of manure, the width and length of the facility base and the width and length of the manure in the storage facility.

» Length of Freeboard

The length of freeboard can be measured using a weighted rope or tape measure.

Estimating Height (Depth) of Manure in a Storage Facility

The height of manure in a facility is calculated using the mathematical principles for a right-angled triangle (Figure 4.1.12). The height (depth) of the manure is calculated using the freeboard length measurement, the slope angle of the wall reported in degrees and length of the sloped wall.

The slope of the wall is determined by subtracting the measured slope angle from 90°. The 'cosine' of the calculated angle from the slope, referred to as 'cosine' factor, is provided in Table 4.1.5.

Calculated slope angle = 90° - measured slope angle

The height of manure is calculated as:

Manure height = cosine factor of calculated slope angle x (length of sloped wall – freeboard)



Table 4.1.5 'Cosine' Factor¹ for Measured Slope Angles (degrees)

Measured Angle ² (degrees)	'Cosine' Factor of Measured Angle	Measured Angle (degrees)	'Cosine' Factor of Measured Angle
5	0.9962	50	0.6428
10	0.9848	55	0.5736
15	0.9659	60	0.5000
20	0.9397	65	0.4226
25	0.9063	70	0.3420
30	0.8660	75	0.2588
35	0.8192	80	0.1736
40	0.7660	85	0.0872
45	0.7071	90	0.0000

¹ This table provided the 'cosine' value for various measured angle degrees.

² Round the measured angle off to the nearest value in the table or take the 'cosine' of your measured angle to determine the appropriate angle ratio for the calculation.



Estimating Height of Manure in an Earthen Manure Storage

The measured slope along the wall of an earthen manure storage facility is 70° , and the length of the sloped wall is 8.7 m. The length of freeboard is 2.1 m. The height of manure in the facility is:

Calculated slope angle = 90° - measured slope angle

$$= 90^\circ - 70^\circ$$

= 20° is the calculated slope angle of the wall from the vertical

Cosine factor of 20° is 0.9397, from Table 4.1.5.

The height of manure = 'cosine' of calculated slope angle x (length of sloped wall - length of freeboard)

$$= 0.9397 \times (8.7 \text{ m} - 2.1 \text{ m})$$

$$= 0.9397 \times 6.6 \text{ m}$$

= 6.2 m is the height (depth) of the manure in the storage

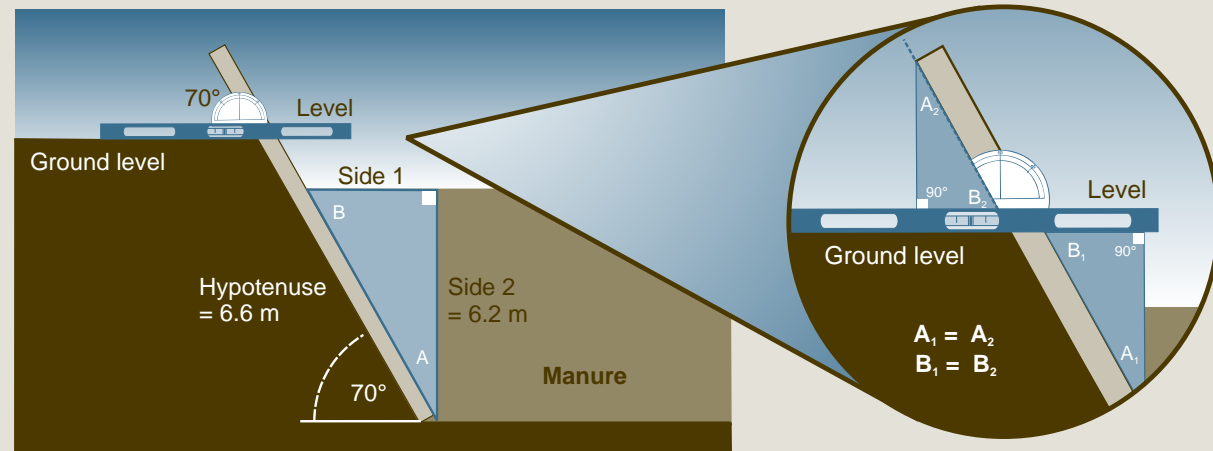

Figure 4.1.14 Using a Board to Estimate the Angles of the Manure Storage Wall to Estimate the Depth of the Manure in the Storage.

Width and Length of the Facility Base

The width and the length of the facility base can be estimated using the length and slope angle on the storage facility walls.

The width of the base is calculated as:

$$\text{Base width} = \text{top width} - 2 \text{ ('cosine' factor of the measured slope angle} \times \text{length of sloped wall)}$$

Similarly, the length of the base is calculated as:

$$\text{Base length} = \text{top length} - 2 \text{ ('cosine' factor of the measured slope angle} \times \text{length of sloped wall)}$$



Calculating Width and Length of a Facility Base

A storage facility has a top width of 24 m and a length of 30 m. The facility walls have a measured slope angle of 70° and a length of 8.7 m.

The width of the base is estimated by:

$$\begin{aligned} \text{Base width (m)} &= \text{top width} - 2 \text{ ('cosine' factor of the measured slope angle (Table 4.1.5) } \times \text{ length of sloped wall)} \\ &= 24 \text{ m} - (2 \times (0.3420 \times 8.7 \text{ m})) \\ &= 24 \text{ m} - (2 \times 2.98 \text{ m}) \\ &= 24 \text{ m} - 5.96 \text{ m} \\ &= 18.0 \text{ m is the estimated base width of the storage facility} \end{aligned}$$

The length of the base is estimated by:

$$\begin{aligned} \text{Base length (m)} &= \text{top length} - 2 \text{ ('cosine' factor of the measured slope angle (Table 4.1.5) } \times \text{ length of sloped wall)} \\ &= 30 \text{ m} - (2 \times (0.3420 \times 8.7 \text{ m})) \\ &= 30 \text{ m} - (2 \times 2.98 \text{ m}) \\ &= 30 \text{ m} - 5.96 \text{ m} \\ &= 24.0 \text{ m is the estimated base length of the storage facility} \end{aligned}$$

Width and Length of the Manure Surface in Storage

To estimate width and length of the top surface of the manure use the exact same calculations as those used to estimate the width and length of the base of the storage facility. Rather than using the length of the facility wall, use the difference between the length of the facility wall and the length of the freeboard.

side bar

These calculations assume that the angle and length of the sloped walls of the facility are the same for all walls. If this is not the case, measurements will need to be collected for each wall.



Calculating Width and Length of the Manure Surface

A storage facility has a top width of 24 m and a length of 30 m. The sidewalls have a measured slope angle of 70° and length of 8.7 m. The length of the freeboard is 2.1 m. The difference between the total length of the facility wall and the length of the freeboard is:

$$\begin{aligned} \text{Difference in length (m)} &= \text{slope length (m)} - \text{length of freeboard (m)} \\ &= 8.7 \text{ m} - 2.1 \text{ m} \\ &= 6.6 \text{ m} \end{aligned}$$

$$\text{Top width} = 18 \text{ m} + 2 (x)$$



Figure 4.1.15 Dimensions for Calculating the Width and Length of the Surface of the Manure in Storage

The width of the top surface of the manure in storage is estimated as:

$$\begin{aligned} \text{Manure width} &= \text{bottom width} + (2 \times (\text{cosine factor of measured slope angle (Table 4.1.5)} \times \text{slope length})) \\ &= 18 \text{ m} + (2 \times (0.342 \times 6.6\text{m})) \\ &= 18 \text{ m} + (2 \times 2.26 \text{ m}) \\ &= 18 \text{ m} + 4.52 \text{ m} \\ &= 22.5 \text{ m is the width of the top of the manure in the storage facility} \end{aligned}$$

The length of the top surface of the manure in storage is estimated as:

$$\begin{aligned} \text{Manure length} &= \text{bottom length} + (2 \times (\text{cosine of measured slope angle (Table 4.1.5)} \times \text{slope length})) \\ &= 24 \text{ m} + (2 \times (0.342 \times 6.6\text{m})) \\ &= 24 \text{ m} + (2 \times 2.26 \text{ m}) \\ &= 24 \text{ m} + 4.52 \text{ m} \\ &= 28.5 \text{ m is the estimated length of the top of the manure in the storage facility} \end{aligned}$$

Calculate Volume of Manure in Storage

Once the facility dimensions are known, the volume of manure in the facility can be calculated.



Calculating Volume of Manure in an Earthen Manure Storage

Figure 4.1.16 shows the dimensions of a manure storage facility. The volume of manure in this earthen manure storage facility can be calculated using these dimensions.

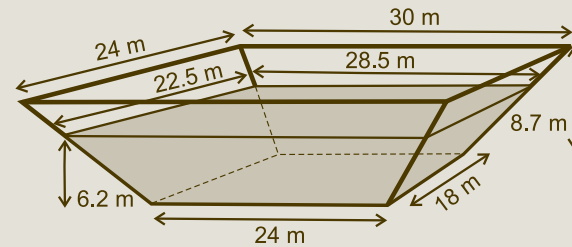

Figure 4.1.16 Liquid Storage Facility with Estimated Dimensions

The base surface area of the facility is calculated as:

$$\begin{aligned} \text{Base Surface Area (A}_{\text{base}}) &= \text{length of base} \times \text{width of base} \\ &= 24.0 \text{ m} \times 18.0 \text{ m} \\ &= 432 \text{ m}^2 \text{ is the estimated base surface area of the storage facility} \end{aligned}$$

The upper surface area of the manure is calculated as:

$$\begin{aligned} \text{Upper Surface Area (A}_{\text{manure}}) &= \text{length of the top of the manure} \times \text{width of the top of the manure} \\ &= 28.5 \text{ m} \times 22.5 \text{ m} \\ &= 641 \text{ m}^2 \text{ is the upper surface area of the manure in the facility} \end{aligned}$$

The volume of manure is calculated using the answers from the two equations above, and is as follows:

$$\begin{aligned} \text{Manure volume (m}^3) &= \text{height}_{\text{manure}} \times [A_{\text{base}} + A_{\text{man}} + \sqrt{(A_{\text{base}} \times A_{\text{man}})}] \div 3 \\ &= 6.2 \text{ m} \times [432 \text{ m}^2 + 641 \text{ m}^2 + \sqrt{(432 \text{ m}^2 \times 641 \text{ m}^2)}] \div 3 \\ &= 6.2 \text{ m} \times [1,073 \text{ m}^2 + \sqrt{(276,912 \text{ m}^4)}] \div 3 \\ &= 6.2 \text{ m} \times [1,073 \text{ m}^2 + 526 \text{ m}^2] \div 3 \\ &= 6.2 \text{ m} \times 1,599 \text{ m}^2 \div 3 \\ &= 9,915 \text{ m}^3 \div 3 \\ &= 3,305 \text{ m}^3 \text{ is the estimated volume of the manure in the storage} \end{aligned}$$

The volume of manure can be converted into litres (L) (or any other measurement) using the conversion factors in Table 4.1.3.

$$\begin{aligned} \text{Manure volume (L)} &= 3,305 \text{ m}^3 \times 1000 \text{ L/m}^3 \\ &= 3,305,000 \text{ L is the approximate volume of manure} \end{aligned}$$



sidebar

Representative sampling of liquid manure for laboratory analysis requires that manure be agitated prior to sampling because nutrients settle into layers in a storage facility over time.

Ideal Time to Estimate Volume and Weight

Estimate weight or volume as close to the time of application as possible. Solid manure will settle and lose moisture over the first few weeks, altering volume and density. This is a lesser concern for volume measurements with liquid manure.

Length of slope of liquid storage facility walls, if not available from design schematics or plans, should be measured when the facility is empty. Similar to solid manure, volume should be estimated as close to the time of application as possible, but before manure in the facility is agitated. Agitation releases potentially harmful gases such as H_2S , which increase personal risk when working around these facilities.

→ summary

- Three reasons for getting an accurate estimate of manure volume or weight: to estimate the required land base for manure utilization, to determine if the operation is subject to additional requirements under AOPA and to develop a time estimate for manure application.
- Estimating the weight of solid manure involves determining pile shape, measuring or estimating key dimensions, calculating pile volume and determining density.
- Estimating the volume of liquid manure involves determining shape of the storage facility and obtaining key dimensions.
- To calculate the volume of a cylindrical storage facility the height of the manure in storage and the diameter of the storage facility are required.
- To calculate the volume of a tapered prism storage facility the following dimensions are needed: top length and width, slope of storage facility walls, length of sloped wall of the facility and length of freeboard.
- Ideally, manure volume and weight should be determined as close to the time of application as possible. Liquid manure volume should be estimated prior to agitation of manure in the facility.

Chapter 4.2

Manure Sampling

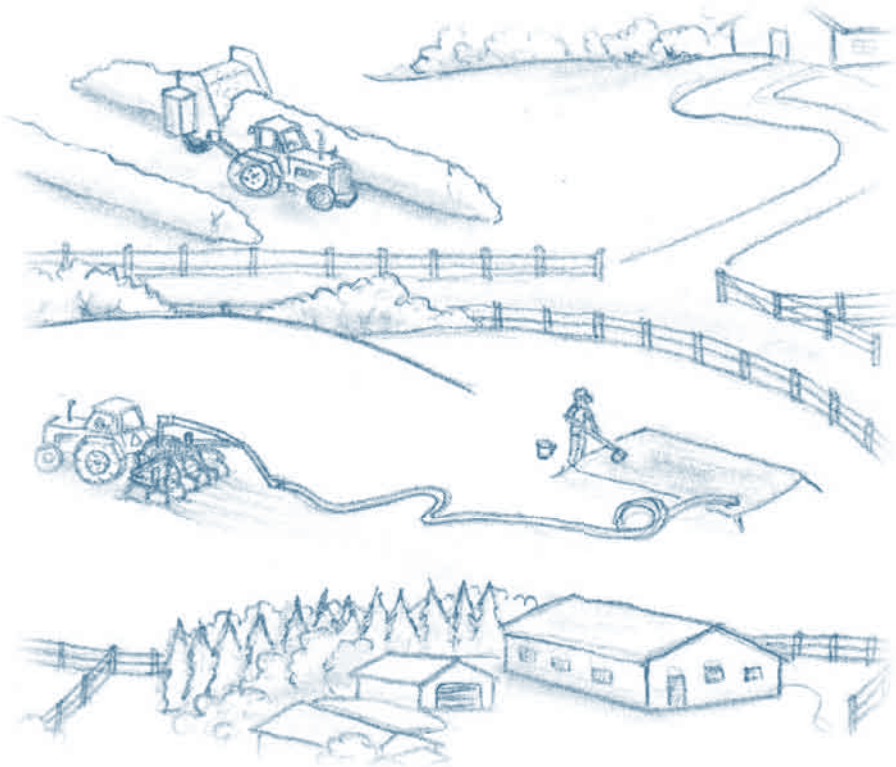

→ learning objectives

- Briefly explain why sampling is preferred over book values for manure nutrient content.
- Develop a manure sampling strategy that addresses sources of variability in manure nutrient content.
- Take representative samples of liquid and solid manure.
- Properly handle and ship manure samples to a lab for analysis.
- List the recommended lab analyses for all manure samples.

more info



The commonly used standard values for manure nutrient content in Alberta appear in the AOPA Manure Characteristics and Land Base Code published by AF. This publication can be obtained from the publications office of AF by calling toll free 1-800-292-5697 or searching Ropin' the Web.



Important Terms

Table 4.2.1 Key Terms and Definitions

Term	Definition
Dilution	The process of making weaker or less concentrated, by the addition of water.
Re-suspend	To mix or agitate a solution (liquid manure) so as to mix the solid material back into suspension.
Spatial Variation	The variation in properties (i.e., nutrient content and manure consistency) laterally across the manure pile or storage, or vertically downward through the manure pile or storage.
Stratification	The formation of layers of sediment and nutrients in a liquid manure storage. The various materials separated out because of differences in size and density.
Temporal Variation	The variation in properties (i.e., nutrient content and manure consistency) that occurs with time in the manure pile or storage.
Total Kjeldahl Nitrogen	This is the amount of total nitrogen contained in an organic material (i.e., manure or soil) as determined by the 'Kjeldahl' digestion method.

To determine an appropriate manure application rate, it is critical to know the nutrient content of manure. This will help meet crop requirements, maximize yields, minimize environmental impact and optimize economic benefit.

Manure Sampling Versus Book Values

Nutrient content of manure is determined from book values or lab analysis. Manure nutrient composition varies widely between farms due to a host of factors such as: differences in animal species, bedding and feeding practices and type of manure (solid or liquid). Book values may not reflect the nutrient composition of individual farms. Therefore, the only way to get reliable, farm specific estimates of manure nutrient content is by sampling and lab analysis (Table 4.2.2).

Table 4.2.2 Variability in Analysed Nutrient Content of Manures Compared with Book Values.

Manure Type	Data Source	Total Solids (%)	Total N (%)	Total P (%)
Dairy	MWPS ¹ (book value)	8.0	0.39	0.19
	Source 1	6.7	0.31	0.11
	Source 2	8.3	0.36	0.15
	Source 3	10.3	0.50	0.21
Swine	Source 4	5.6	0.34	0.13
	MWPS (book value)	1.0	0.06	0.04
Poultry	Samples	0.61	0.17	0.03
	MWPS (book value)	75.0	2.35	2.40
	Samples	66.5	3.02	2.69

¹ Midwest Plan Service 1993

Adapted from Dou et al. (2001)

Sampling Strategies and Manure Variability

Proper manure sampling will ensure the most accurate manure analysis. Manure samples must represent the average nutrient composition of the manure being applied. Two factors influence this:

- Changes in manure composition through time (i.e., temporal variation) as a result of volatilization, precipitation, drying and other natural processes.
- Variation within a pile or storage facility (i.e., spatial variation).

Changes in manure composition through time can be addressed by sampling as close to the time of application as possible (i.e., prior to or during application). This is particularly true for uncovered lagoons and pits, which are subject to seasonal variations in temperature and precipitation. In contrast, manure from under-barn concrete pits or covered aboveground tanks receive limited exposure to environmental influences and vary little between applications.

The nutrient content of solid manure can vary from one part of the pile to another. This variation depends on the distribution of bedding materials and the depth of the dried surface layer. The nutrient content of liquid manure can be variable due to solids settling with time, referred to as nutrient stratification (Figure 4.2.1). If variability is not addressed, manure analyses will not be representative of the nutrient content of the manure being applied. This could result in management decisions that lead to over or under nutrient application for crops, and potential loss of revenue.

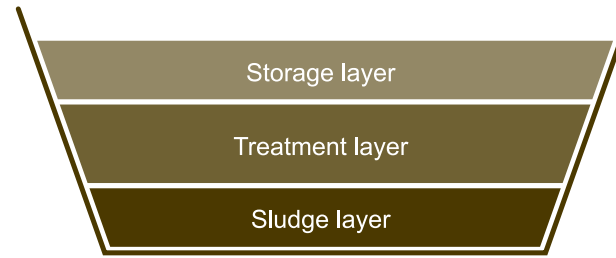

Adapted from Zhang et al. (not dated)

Figure 4.2.1 Stratification of Nutrients in a Liquid Manure Storage Facility

Differences in nutrient content throughout a manure pile can be addressed by using proper sampling procedures. To select an appropriate sampling strategy, it is important to consider the advantages and disadvantages of sampling before and during manure application (Table 4.2.3).

sidebar

Changes in nutrient content of stored manure occur slowly. A delay of 30 to 60 days between sampling and application will result in minor changes in nutrient content of the manure; therefore, there may be no need to resample.

sidebar

Sampling during application can account for changes in manure composition due to nutrient conversions, evaporation, and dilution.

sidebar

Generally, total N and P concentration increases with depth, whereas K concentration decreases.

Table 4.2.3 Advantages and Disadvantages of Sampling Manure Before or During Application

Parameter	Sampling Strategy	
	Sampling Prior to Application	Sampling During Application
Timeliness of Test Results	<input checked="" type="checkbox"/> Manure test results can be used to calculate this year's application rates.	<input checked="" type="checkbox"/> Cannot use analysis of samples collected during spreading to calculate this year's application rate.
Accuracy of Analysis	<input checked="" type="checkbox"/> Manure tests may not be accurate or representative because manure is not thoroughly mixed.	<input checked="" type="checkbox"/> Manure tests will be more reliable because sub-samples can be collected as the manure is being applied, getting a more representative sample.
Difficulty in Collection	<input checked="" type="checkbox"/> Large equipment or agitation may be required to get a representative sample from manure storage.	<input checked="" type="checkbox"/> Minimal time required to sample during application.
Safety	<input checked="" type="checkbox"/> Sampling from storage facilities, especially lagoons or tanks, can be dangerous due to the risk of falling in or being overcome by gases (H ₂ S and NH ₃).	<input checked="" type="checkbox"/> Sampling from application equipment reduces risk of falling in or being overcome by gases (H ₂ S and NH ₃).

Sampling Strategy in Relation to Planning Application

Manure nutrient content and fertility recommendations are used to calculate manure application rates and additional fertilizer requirements. The benefit of manure sampling before application is the availability of test results to calculate application rates prior to application. The limitation is that the analysis may not be representative because the manure is not well mixed. An accurate analysis of manure nutrient content will yield a more reliable manure application rate.

When samples are collected during application, test results will not be available to calculate application rates for the current application. Rather, historical analyses (if available) or book values can be used to calculate the rate for the current application (Figure 4.2.2). When sampling during application, the current year's analysis has two purposes:

- Used to verify nutrient application rate and determine if additional fertilizer inputs are needed.
- Used to calculate manure application rates in subsequent years.

Three to five years of manure analyses should provide enough information to develop reliable estimates of average manure nutrient content for an operation. Historical analyses will provide a more representative manure nutrient profile to calculate manure application rates for a specific operation compared to book values. Once historical averages have been developed, there is less of a need for annual manure sampling. However, if any component of the animal management, manure storage or handling system substantially changes, new historical averages will need to be developed.

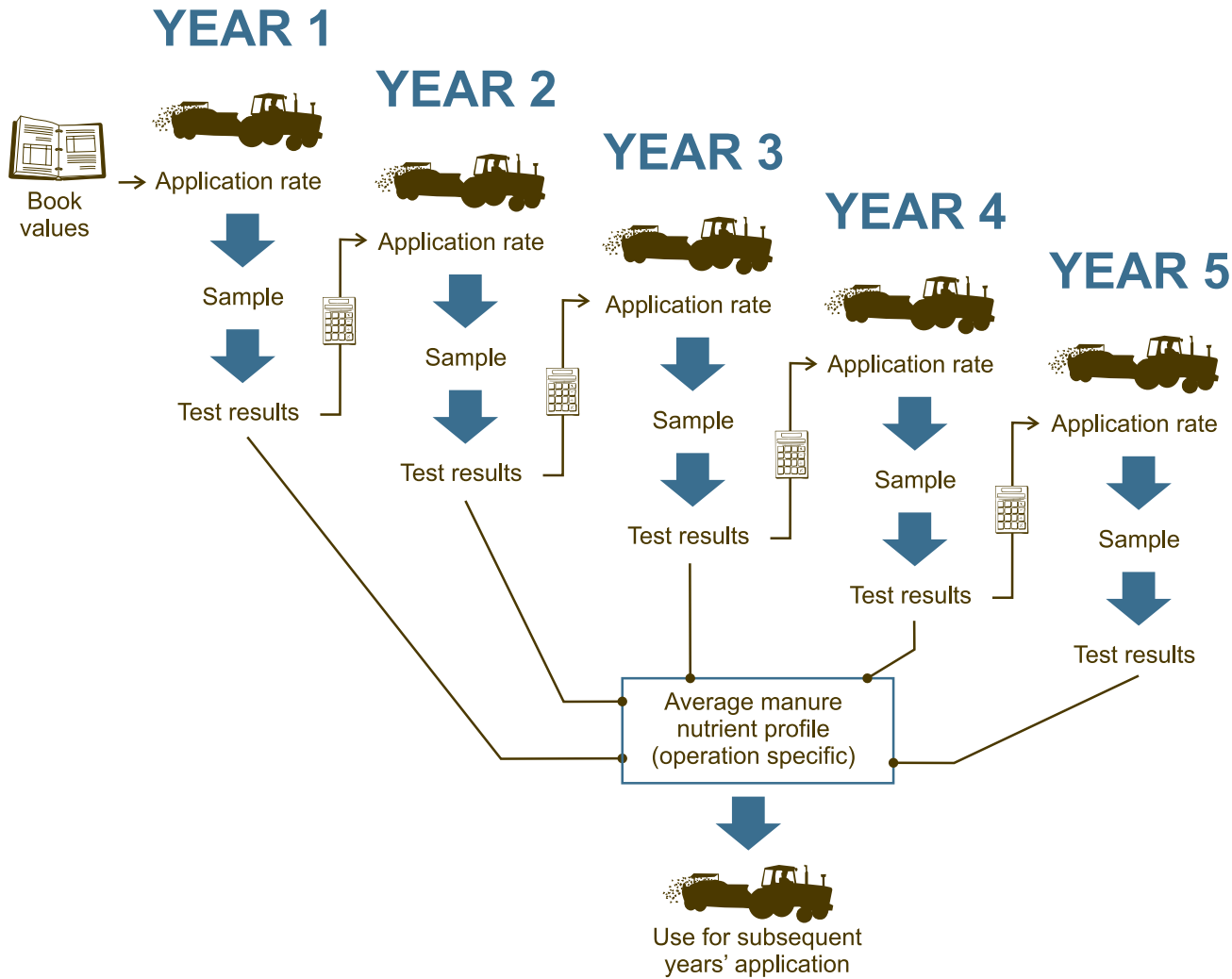

Figure 4.2.2 Sampling During Application and Nutrient Management Planning

more info



For more information on air quality in barns and managing hazardous

gases found in liquid manure storage facilities, check out these factsheets, which can be obtained from the publications office of AF by calling toll free at 1-800-292-5697 or search by Agdex number or title on Ropin' the Web.

- AF. 2004. Air Quality Resources for Alberta Livestock.
- AF. 2004. Hydrogen Sulfide Emissions and Safety. Agdex 086-2
- Ontario Ministry of Agriculture, Food and Rural Affairs. 2004. Hazardous Gases. Agdex 721. (www.omafra.gov.on.ca/english/engineer/facts/04-087.htm)

tip



Use only plastic buckets for collection and mixing of manure samples.

Galvanized steel buckets can affect the results of the lab analysis for micronutrients. Do not use glass containers for sampling or shipping sub-samples due to the risk of breakage and personal injury.

tip



Avoid sampling un-agitated liquid storage facilities. It is extremely difficult to get a representative sample of the lagoon sludge layer without agitation.

Sampling Techniques for Liquid Manure

Before sampling, consult the manure-testing laboratory on lab-specific requirements for sample size, packaging and shipping, turn-around times, analytical options, and costs. Some labs provide containers, labels and submission forms for manure samples, and may cover the shipping costs depending on the number of samples submitted. A list of labs that analyze soil and manure samples is presented in Appendix 3.

Sampling During Application

Assemble the following equipment:

- 20 L (5 gal) plastic pail
- small collection can, pole and cup device (Figure 4.2.3), small bucket, or pan
- clean, plastic bottle with a screw-on lid

Hazards Associated with Liquid Manure Storage Facilities

Liquid manure storage facilities present several hazards to personal safety. Gases such as hydrogen sulphide (H_2S) and ammonia (NH_3) can cause symptoms ranging from headaches and eye irritation to death depending on length of exposure and gas concentration.

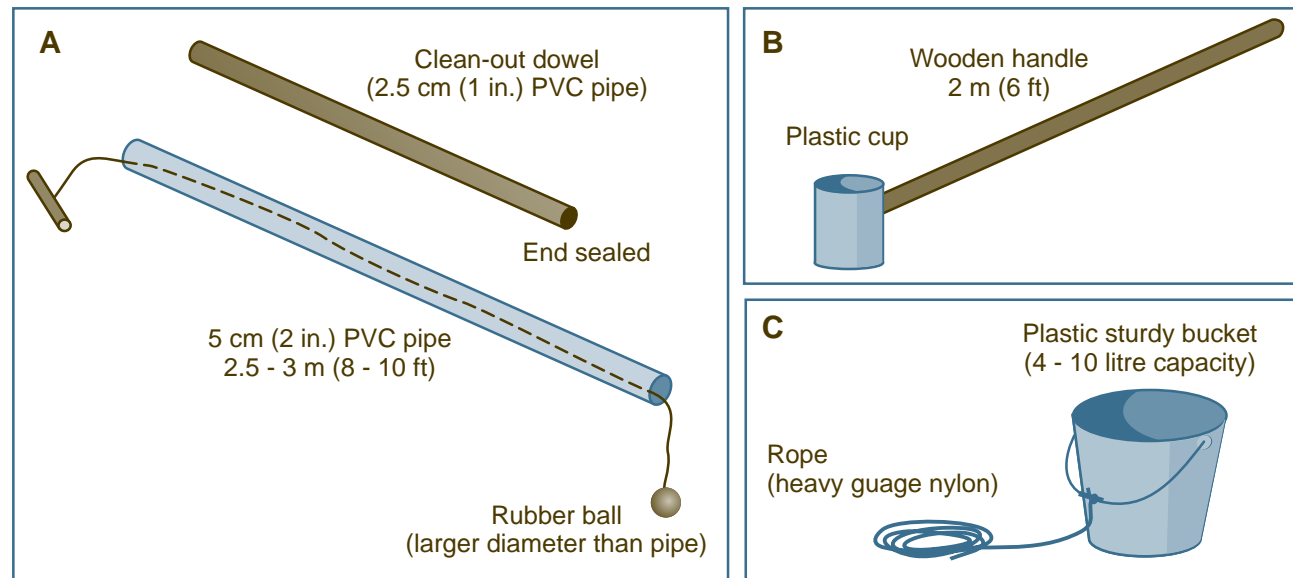

Adapted from Coffey et al. 2000

Figure 4.2.3 Liquid Manure Sampling Devices: (a) Composite Sampling Device, (b) Pole-and-Cup Sampling Device, (c) Bucket with Rope

Follow the steps below to get a representative sample during application.

Sampling Liquid Manure During Application

1. If sampling from the flow of manure as it is being pumped from storage into the applicator, take several samples from the pump outlet.

If sampling from a drag hose system or tank spreader in the field, collect samples from the injectors as they are lifted from the ground or from a tap near the pump.

If sampling from broadcast spreaders or irrigation applicators, use buckets or catch pans randomly placed in the field. This method of collection provides a good picture of N loss through volatilization during surface application.

2. Combine all samples into one composite sample, in a 20 L (5 gal) pail or other plastic container, and mix thoroughly.
3. Withdraw a sub-sample from the pail and put it into the plastic bottle. Ensure the bottle is no more than two thirds full to allow for expansion from manure gas or if the contents are frozen (if freezing is required prior to shipping for analysis). Secure the lid to prevent leakage.
4. Label the plastic bottle with the date, time, farm name, and manure type, and seal in a plastic bag in case of leakage. Keep sub-samples cool and transport immediately to the lab for processing. If samples cannot be transported on the day of collection, freeze them until transport is possible to stop nutrient transformation reactions and the buildup of gases.

Sampling from Storage

If sampling from a multi-stage storage system, only sample the lagoon to be emptied. When taking a sample directly from a liquid storage facility, make sure the material is thoroughly agitated for two to four hours using an agitation pump or other equipment designed for this purpose. Agitation mixes the different layers and re-suspends the nutrient-rich sludge layer.

Assemble one of the sampling devices described in Figure 4.2.3. Collection from storage will also require:

- 20 L (5 gal) plastic pail or larger plastic garbage can
- clean, plastic bottle with screw-on lid

Follow the steps below to get a representative sample from a storage facility.

tip



Avoid sampling at the beginning and end of pumping, as these samples are less reflective of the storage than those taken midway through the pumping process. A good rule of thumb is to collect one sample for approximately every 1,000,000 L pumped.

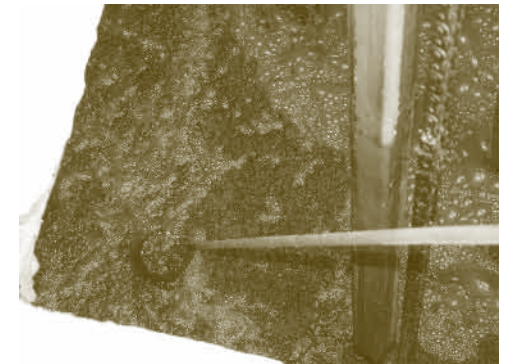



Sampling Liquid Manure from a Storage Facility

1. Toss the bucket or extend the sampling device (composite or pole-and-cup) into the lagoon at least two metres (6 ft) from the edge. If using the bucket-and-toss method, begin quickly pulling the bucket back to the bank as soon as it breaks the surface of the liquid, pulling it through the top 30 cm (12 in). If possible, avoid collecting any floating debris or scum remaining on the surface after agitation.

If using the composite sampling device, extend it far enough to collect a column of manure and then seal off the tube using either a ball plug on the bottom (attached to a handle at the top) or by covering the top of the pipe with a hand to create an air lock.

2. Empty the sample into the 20 L (5 gal) pail or garbage can. If using a composite sampling device, place the end of the pipe into the 20 L (5 gal) pail and release the airlock or ball plug to empty the pipe. Depending on the size of the bucket used (bucket-and-toss), a plastic garbage can may be required to collect and mix samples.
3. Move around the lagoon and repeat the above procedure eight to 12 times (four to six times if using bucket-and-toss method) to obtain samples from various locations around the perimeter of the lagoon. Mix collected samples thoroughly in a plastic pail.
4. Refer to steps 3 and 4 in the procedure for sampling liquid manure during application for sub-sampling and handling instructions prior to shipping.

Sampling Techniques for Solid Manure

When sampling manure, take note of visible variations in moisture and bedding. When considerable variation is observed, multiple composite samples should be taken and sent for analysis. This will ensure that test results reflect the average for the entire source. Avoid sampling from areas where moisture and bedding is considerably different from the average of the pile.

The following section outlines procedures for:

- In-barn sampling of poultry litter
- Sampling during application
- Sampling stockpiles

In-Barn Sampling of Poultry Litter

The composition of dry litter can vary throughout the barn. For instance, material under feeders and waterers is different than that material against the walls. Consider these differences when devising a strategy for collecting samples. There are two suggested methods for in-barn sampling of poultry litter: the point and trench methods.

Assemble the following equipment:

- 20 L (5 gal) plastic pail
- wheelbarrow
- narrow, square-ended spade or solid manure-sampling probe (Figure 4.2.4)
- tarp or piece of plywood
- one or more large plastic re-sealable freezer bags

Follow these steps when using the point method to sample poultry litter:

sidebar

The point and trench methods strive to collect samples that represent the litter pack throughout the entire barn.

tip



Be careful not to collect soil from beneath the litter in barns with earthen floors when sampling. The soil will skew the nutrient content reported in the manure analysis.

Point Method for In-Barn Sampling Poultry Litter

1. Assess the appearance of the litter pack in the barn. If there are visible differences in composition in certain areas, collect a proportionate number of samples to represent these areas. For example, if the area under feeders represents 10 percent of the barn area, ensure 10 percent of the samples are from these areas. Use the zigzag sampling pattern (Figure 4.2.5).
2. Randomly collect 15 to 20 samples of equal amount with a spade or solid manure-sampling device from the litter pack down to the depth the litter is to be removed. To collect the samples, clear a small trench the width of the spade and the depth of the litter. Take a 3 to 8 cm (1 to 3 in) slice of litter the entire depth of the trench as a sample (Figure 4.2.6). Place each sample in a plastic pail or wheelbarrow.
3. When you have collected 15 to 20 samples, thoroughly mix samples in the pail or wheelbarrow or on a tarp or piece of plywood. Collect a sub-sample from this mixture, and fill the plastic bag two thirds full to allow for gas expansion. Force the excess air from the bag, seal and double bag.
4. Label the bag with important information including date, time, farm name, manure type, and any other information requested by the testing lab.

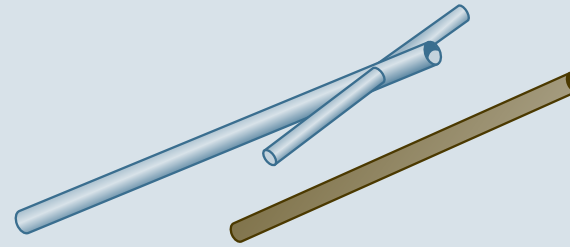

Thin-walled metal tubing
2.5 cm (1 in.) Diameter
Clean-out dowel (broomstick)

Adapted from Coffey et al. 2000, Shaffer and Sheffield (not dated)

Figure 4.2.4 Solid Manure-Sampling Probe



⊗ = sample spot

Adapted from Zhang et al. (not dated)

Figure 4.2.5 Zigzag Sampling Pattern (parallel feed and water supply lines run lengthwise)

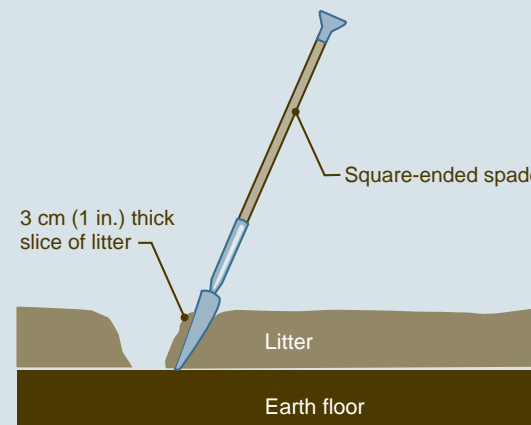

Adapted from Coffey et al. 2000

Figure 4.2.6 Point Sampling Procedure

Follow the steps below when using the trench method to sample poultry litter.

Trench Method for In-Barn Sampling of Poultry Litter

1. Starting at the centre line of the barn, dig a trench 15 cm (6 in) wide to the sidewall of the barn (Figure 4.2.7). If feed and water lines run parallel, dig the sampling trench perpendicular so that litter under these areas are adequately represented in the sample. If the barn has an earthen floor, avoid collecting soil with the sample.
2. Place all litter removed from the trench into the wheelbarrow. If the amount of litter collected exceeds the capacity of the wheelbarrow, each time the wheelbarrow is two-thirds full, thoroughly mix the material and remove one shovel full and add it to the 20 L (5 gal) pail. Empty the remaining litter from the wheelbarrow.
3. Continue collecting (and sub-sampling as necessary) until the trench reaches the opposite wall.
4. Thoroughly mix the material collected in the pail. Collect a sub-sample from this composite mixture and fill the plastic bag two thirds full to allow for gas expansion. Force excess air from the bag, seal and double bag.
5. Label the bag with the date, time, farm name, manure type and any other information requested by the testing lab.

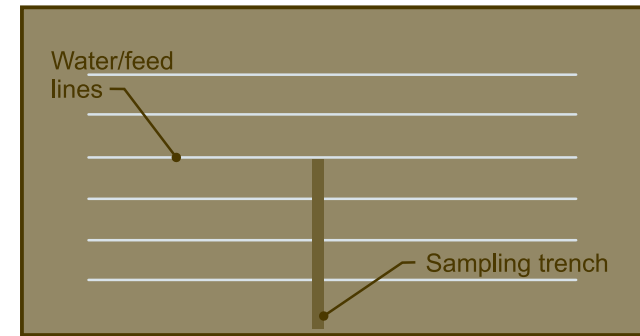

Adapted from Coffey et al. 2000

Figure 4.2.7 Trench Sampling Method

Sampling During Application

Sampling during application is easier and safer than trying to sample from a pile.

Samples should be taken to reflect variability in the material being applied. If manure being applied comes from several sources (e.g., piles, barns, corrals) composite samples should be developed for each source. The number of composite samples required to get an accurate representation of the manure depends on the variability of the material and the volume to be applied. For volumes less than 1000 tonnes or material of consistent composition a single composite sample may be required. A minimum of three composite samples should be collected for manure volumes greater than 1000 tonnes.

Samples should be collected throughout the manure application process (i.e., beginning, middle and end). In situations where manure application can take several days (e.g., feedlots), separate composite samples can be prepared for each stage of the process or even for each day. When samples are taken over a span of several days, interim storage and handling of samples becomes important. Be sure to protect sampled material from the elements to minimize moisture and nutrient (e.g., N) changes.

It is recommended that 15 to 20 samples be collected to form each composite sample. Sub-samples from each composite sample are taken and combined to form a single composite sub-sample, which is sent for analysis. Alternatively, each of the sub-samples can be sent for separate analysis. This may allow more site-specific nutrient management planning, particularly if the field that received manure represented by a specific composite sample (particular day, source or stage of the application process) was recorded.

Sampling Solid Manure During Loading

1. Collect several grab samples from selected loads using a shovel, pitchfork or sampling probe. These grab samples will count as a single sample for that load. Avoid large chunks of bedding.
 2. Place grab samples in the wheelbarrow. If the amount of manure collected exceeds the capacity of the wheelbarrow, each time the wheelbarrow is two-thirds full, thoroughly mix the material and one or two shovels full to the pail or suitable mixing area (tarp, plywood or concrete pad). Collect samples from 15 to 20 wheelbarrow loads if the material is relative consistent and representative of the manure applied for a particular day, source, or stage of the application process. For more variable material, a greater number of loads may need to be sampled or more composite samples may need to be collected.
 3. To sub-sample, begin by thoroughly mixing material collected in the pail or from the mixing area with a pitchfork or shovel. Break up any large clumps.
- There are two strategies for sampling manure during application: during loading of application equipment, or as manure is being applied. In either case, the following equipment is required:
- 20 L (5 gal) plastic pail or larger plastic garbage can
 - wheelbarrow
 - shovel, pitchfork or solid manure-sampling probe (Figure 4.2.4)
 - several tarps, plastic sheets or a piece of plywood
 - one or more large plastic freezer bags
4. Divide the well-mixed manure into four portions and then discard two of the four portions. Combine the remaining two portions and mix.
 5. Repeat step 4 until approximately 0.5 kg (1 lb) of material remains. This will be the composite sub-sample for analysis.
 6. Place the composite sub-sample in a plastic bag filled two-thirds full to allow for gas expansion.
 7. Squeeze excess air out of the bag, seal and double bag to prevent excessive odour and leaking.
 8. Label bag with date, time, farm name, manure type, and any other information requested by the testing facility.
 9. Keep bagged composite sub-samples cool and ship immediately to the lab. Store samples that cannot be delivered immediately in a freezer.
 10. Repeat steps 1 to 3 until all manure has been applied.

tip



For severely weathered piles, it is best to sample during application rather than trying to obtain a representative sample. The weathered exterior of uncovered manure piles does not accurately represent the majority of the material in the pile. Rainfall generally moves water-soluble nutrients down into the pile while volatile compounds generally gas-off the weathered exterior.



s i d e b a r

Nutrient content should stabilize within two weeks of creating a new pile or turning an existing pile.

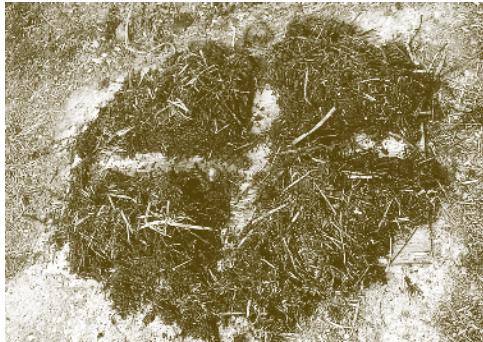

Solid manure can also be collected during field application. Send a minimum of three or more composite sub-samples for analysis per field, depending on the size of the area. Although messy, this method has the added benefit of being more accurate because any N lost through volatilization during surface application will not be included in the samples.

Sampling Solid Manure During Application

1. Divide the area to receive manure into sample collection zones according to the planned pattern of application. Place several (five to six) tarps in each zone such that they catch the manure from several spreader passes across the field (Figure 4.2.8). Manure collected on tarps in each zone of the application area serves as the basis for building composite-sub-samples for analysis.
2. Thoroughly mix the manure sampled from each tarp. Depending on the size of the tarp, take two to three samples using the shovel or pitchfork from each tarp and place them in the wheelbarrow. Avoid larger pieces or chunks of bedding.
3. If the amount of manure collected exceeds the capacity of the wheelbarrow, each time the wheelbarrow is two-thirds full, thoroughly mix the material and remove one or two shovelfulls to the pail or suitable mixing area.
4. Collect samples from all collection zones and take this material to the designated mixing area (tarp, plywood or concrete pad). Follow the method described in “Sampling Solid Manure During Application”, steps 3 to 9, to develop a composite sub-sample of solid manure.
5. Repeat steps 1 through 4 for all sample collection zones.

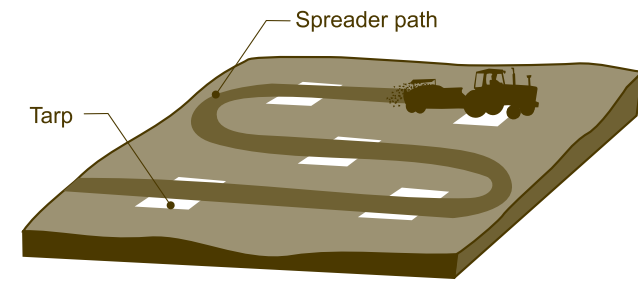

Figure 4.2.8 Tarp Placement for Collecting Solid Manure During Application

Sampling Stockpiled Manure

Stockpiles of solid manure, litter and compost are highly variable, so as a general rule, the more variable the stockpile of manure the more extensive the sampling strategy. Large, highly inconsistent piles require more extensive sampling compared to smaller, fresher or more consistent piles.

To get an accurate representation of most solid stockpiles, send away a minimum of three composite sub-samples based on samples taken from 10 to 15 points on the pile (i.e., three composite samples based on a total of 30 to 45 sampling points). If a portion of the pile is being applied, sample only that portion.

To obtain a representative sample from a solid manure storage facility, collect multiple sub-samples from throughout the pile when the nutrient content is fairly stable. Do not sample from freshly piled or turned manure unless it is going to be spread in the next few days.

Assemble the following equipment:

- 20 L (5 gal) plastic pail
- wheelbarrow
- shovel, pitchfork or solid manure-sampling probe (Figure 4.2.4)
- tarp, a piece of plywood or a concrete mixing area
- one or more large plastic re-sealable freezer bags

Repeat the procedure below for each of the three composite sub samples being sent for lab analysis.

Sampling Solid Manure or Compost from Stockpiles

1. Select 15 to 20 points on the pile uniform distances apart. Include sampling points in the centre of the pile or pack as well as near the edges. To get samples from the centre of a large pile, you may need to use a front-end loader and sample from material in the bucket of the loader.
2. At each point selected, remove the top crust layer until a fresh, moist surface is exposed. This layer may be as thick as 30 cm (1 ft) or more.
3. Use a pitchfork, spade, or manure collection probe to sample the pile to a minimum depth of 50 cm (20 in) into the pile. When sampling, avoid large chunks of bedding.
4. Deposit samples in a wheelbarrow. If the amount of manure collected exceeds the capacity of the wheelbarrow, each time the wheelbarrow is two-thirds full, thoroughly mix the material and one or two shovels full to the pail or suitable mixing area (tarp, plywood, or concrete pad).
5. Continue collecting until all 15 to 20 points selected on the pile have been sampled. Store samples in cool (e.g., shaded) location, or cover with a tarp until sampling is complete.
6. Follow the method described in “Sampling Solid Manure During Loading”, steps 3 to 9, to develop a composite sub-sample of solid manure.
7. Repeat steps 1 through 6 until the appropriate number of sub-samples has been collected.

Handling and Shipping Samples

Large, re-sealable freezer bags are generally suitable for solid manure, while one-litre plastic bottles with airtight closures are acceptable for liquid manure samples. Take measures to prevent leakage by ensuring a tight seal on the bag or container and double bagging as an extra precaution.

Take the following precautions when handling manure samples for analysis:

- Fill liquid manure containers no more than two-thirds full to provide air space in the container for manure gases and to allow for expansion if the contents are frozen.
- Keep samples cool by refrigeration or placing on ice until they are transported to the lab. Do not allow the samples to sit in a warm environment such as the dashboard of the truck or trunk for longer than a few hours.
- Transport samples within a day. If this is not possible, freeze samples until they can be shipped.
- Ensure samples spend no more than two days in transit.
- Clearly label all samples with a permanent marker. Samples should be labeled with a minimum of farm name, contact information, date and time the sample was collected and type of manure.

sidebar

Elevated temperatures promote microbial activity and can result in nutrient conversions that alter the analyzed nutrient content of the sub-sample.



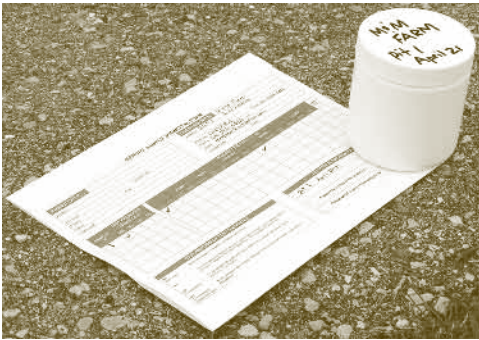

Recommended Analyses for Manure Samples

Laboratories offer a variety of tests and analyses packages for manure (costs can vary). The recommended tests for nutrient management planning purposes include:

- moisture content, dry matter content, or total solids
- total N (Total Kjeldahl Nitrogen TKN)
- ammonium N ($\text{NH}_4\text{-N}$)
- total P
- total K

Optional tests for manure samples include: nitrate-nitrogen ($\text{NO}_3\text{-N}$), pH, total carbon or carbon to nitrogen ratio (C:N), electrical conductivity, chloride (Cl), sulphur (S), sodium (Na), calcium (Ca), magnesium (Mg) and micronutrients such as copper (Cu), manganese (Mn), zinc (Zn) and iron (Fe).

It is usually not necessary to analyze manure for mineral constituents such as Ca, Mg, Zn and boron (B). Most manure contains significant quantities of these minerals and fields with a history of manure application are rarely deficient.

→ summary

- **Manure book values may not reflect the** nutrient composition of individual farms because nutrient composition varies widely. **The only way to get reliable, farm specific** estimates of manure nutrient content is by sampling and lab analysis.
- Changes in manure composition with time can be addressed by sampling as close to the time of application as possible. Differences in nutrient content throughout a manure pile can be addressed by using proper sampling procedures.
- To obtain a representative manure sample, collect manure from throughout the storage or throughout the application process. Sample liquid manure only after thorough agitation.
- Ensure that samples sent for analysis are **handled appropriately: fill liquid manure** containers only two-thirds full, keep samples cool, transport samples within a day and clearly label all samples.
- The key analyses to request from the testing facility include: moisture content (or dry matter/total solids content), total N (Total Kjeldahl Nitrogen), $\text{NH}_4\text{-N}$ and total P.

Chapter 4.3

Manure Test Interpretation

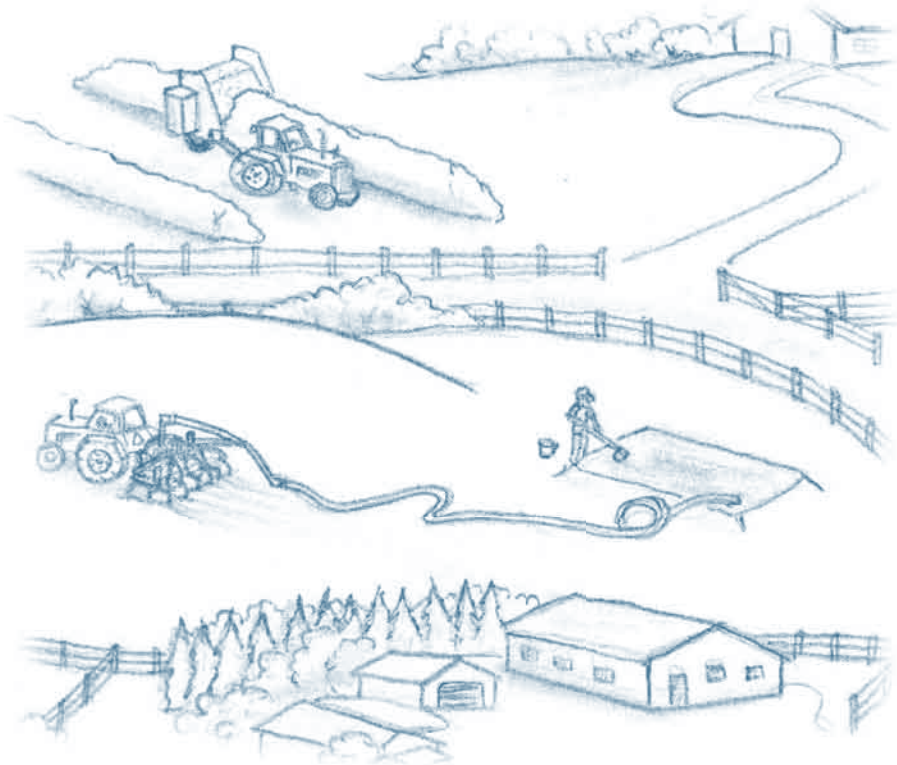

➔ learning objectives

- Convert between units on a manure test report.
- Estimate available organic nitrogen and total crop available nitrogen from manure test information.
- Estimate crop available phosphorus and potassium from manure test information.
- Identify the relevance of additional manure test parameters for nutrient management.



Important Terms

Table 4.3.1 Key Terms and Definitions

Term	Definition
Crop Available Nutrient	Nutrients (e.g., nitrogen (NO ₃ -N)) that are in a form that plants can absorb and use.
Retained Ammonium-N	The amount of ammonium-N corrected to account for expected N losses that occur during application.

The most reliable source of information regarding manure nutrient content is obtained through laboratory analysis of a representative manure sample. Laboratories provide a range of manure analyses, but it is important that results be interpreted properly. The remainder of this chapter will focus on interpreting the results of manure analyses to facilitate nutrient management planning.

Book Values and Manure Test Results

Book values for manure nutrient content can be used to verify that manure test results are within expected ranges. If test results appear either low or high in comparison to book values, contact the testing facility to verify that there were no errors made during either analysis or data entry. Alternatively, extreme results may suggest faulty sampling method or inappropriate handling of samples prior to sending for analysis.

All laboratories generate reports that are returned to the person who submitted the manure samples for analysis. Every lab will have their own unique format of how this information is delivered, but all reports should contain the same basic information.

General Information on the Report

The report will identify the person to whom the report is to be sent as well as information that helps identify the sample and type of the manure (#1 and #2 in Figure 4.3.1). When reviewing test reports, verify that the information is accurate and review any comments included on the report (#7).

The report should include dates when the sample was received and processed (#3). Review these handling dates to see if there were any unusual delays in shipping that might affect the accuracy of the results. If not stated on the report, contact the lab to determine whether samples are retained for a period following analysis, in case analysis must be repeated to verify unusual results.

Some reports will also include reference to the procedure or analytical method used for individual nutrients or parameters (#6). If using different labs from year to year, this information can help verify that labs are using the same analytical procedures so that comparisons of nutrient content between years are valid.

Reporting Units

Typical laboratory analyses and reporting units are listed in Table 4.3.2 (see also #4 and #5 in Figure 4.3.1). Note that on a test report some of the values are measured directly while others are calculated from the results of analyses.

Preferences for the units used to express nutrient content of manure, should be indicated when submitting samples for analysis. It may be necessary to convert units appearing on the lab report, depending on testing laboratory and the units required for subsequent calculations (Table 4.3.3).

Table 4.3.2 Typical Laboratory Analyses and Report Units for Manure

Parameter	Measured or Calculated	Report Units (Solid)	Report Units (Liquid)
Moisture (or Solids)	Measured		%
pH	Measured		pH scale
EC	Measured		deciSeimens/metre (dS/m)
C:N ratio	Calculated		Ratio (Total C:Total N)
Total N	Measured		
Organic N	Calculated		
Ammonium N	Measured		
Nitrate N	Measured		
Total Phosphorus	Measured	%	%
Phosphate (P ₂ O ₅)	Calculated	mg/kg	mg/L
Total Potassium	Measured		
Potash (K ₂ O)	Calculated	kg/tonne	kg/1000 L
Total Sulphur	Measured		
Sodium	Measured	lb/ton	lb/1000 gal
Calcium	Measured		
Magnesium	Measured		
Micronutrients	Measured		

Created by Len Kryzanowski 2007

“As Received” Versus Dried Basis

Manure nutrient content on a laboratory report is only useful if expressed on a wet (or “as received”) basis, since wet manure is what is being applied. If it is unclear from the laboratory report if this is the case, contact the laboratory for clarification. To convert nutrient content from a dry basis to a wet basis, use the following equation:

$$\text{Nutrient content}_{(\text{wet basis})} = \text{nutrient content}_{(\text{dry basis})} \times [1 - (\text{moisture content} (\%) \div 100)]$$

Table 4.3.3 Conversions for Units Commonly Appearing on Manure Test Reports

Starting Unit	Multiply By	Desired Unit
Solid Manure		
%	10	kg/t
%	20	lb/tn
kg/t	2	lb/tn
mg/kg	0.001	kg/t
g/kg	1	kg/t
t/ha	0.4461	tn/ac
Liquid Manure		
%	10	kg/m ³
kg/m ³	1	kg/1000 L
%	100	lb/1000 gal
kg/1000 L	10	lb/1000 gal
mg/L	0.001	kg/1000 L
g/L	1	kg/1000 L
ppm	1	mg/kg and mg/L
L/ha	0.089	gal/ac

Estimating Available Nutrient Content

Laboratory results will typically include measurements of total N, ammonium N (NH₄-N), total P and total K. Generally there is little nitrate NO₃-N in raw manure; therefore, there is no value to requesting this analysis. However, NO₃-N is present in composted manure and therefore a nitrate analysis should be requested. In order for these measures to be useful for nutrient management planning, the availability of each must be considered. Since a significant proportion of many nutrients are in organic forms not immediately available to the crop, estimating crop availability represents a real challenge. Manure application rate should be based on estimated available nutrient content.

Crop Available N

Crop available N estimates the amount of total manure N that could be available for crop use in the year of application. For this estimate, manure test results along with manure application method and timing can be used. Most labs provide measures of total and ammonium N (NH₄-N). The difference of these two parameters provides an estimate of organic N in the manure:

$$\text{Organic N} = \text{Total N} - \text{NH}_4\text{-N}$$

Although mineralization of organic N is controlled by soil moisture and temperature conditions, it is safe to assume that 25% of organic N will be mineralized to crop-available forms in the year following application:

$$\text{Available Organic N (year of application)} = \text{Organic N} \times 0.25$$

Additional organic N will be mineralized in subsequent years and can be estimated when planning future manure applications.

$$\text{Available Organic N (year 2)} = \text{Organic N} \times 0.12$$

$$\text{Available Organic N (year 3)} = \text{Organic N} \times 0.06$$





Calculating Available Organic Nitrogen Content

An analysed sample of swine manure was found to contain 3.5 kg/1000 L total N and 1.8 kg/1000 L of $\text{NH}_4\text{-N}$. The estimated organic N content in this manure is:

$$\begin{aligned} \text{Organic N content} &= \text{Total N} - \text{NH}_4\text{-N} \\ &= 3.5 \text{ kg/1000 L} - 1.8 \text{ kg/1000 L} \\ &= 1.7 \text{ kg/1000 L} \end{aligned}$$

The amount of organic N that is expected to become crop available over the next three years is:

$$\begin{aligned} \text{Available Organic N (year of application)} &= \text{Organic N} \times 0.25 \\ &= 1.7 \text{ kg/1000 L} \times 0.25 \\ &= 0.425 \text{ kg/1000 L} \end{aligned}$$

$$\begin{aligned} \text{Available Organic N (year 2)} &= \text{Organic N} \times 0.12 \\ &= 1.7 \text{ kg/1000 L} \times 0.12 \\ &= 0.204 \text{ kg/1000 L} \end{aligned}$$

$$\begin{aligned} \text{Available Organic N (year 3)} &= \text{Organic N} \times 0.06 \\ &= 1.7 \text{ kg/1000 L} \times 0.06 \\ &= 0.102 \text{ kg/1000 L} \end{aligned}$$

Approximately 0.425 kg/1000 L of N will become available to the crop from the organic portion of the manure N in year of application (year 1). An additional 0.204 kg/1000 L of N will come available to the crop in the first year after application (year 2) and 0.102 kg/1000 L of N will come available to a crop in the second year after application (year 3).

Manure $\text{NH}_4\text{-N}$ can be readily crop available, but is also at risk of being converted to ammonia (NH_3) and lost via volatilization. Volatilization losses depend on manure placement, weather conditions during application, and

the elapsed time between application and incorporation. Table 4.3.4 provides $\text{NH}_4\text{-N}$ retention factors to correct total $\text{NH}_4\text{-N}$ for expected losses after application.

Table 4.3.4 Manure Ammonium Nitrogen Retention Factors Based on Expected Volatilization Losses Occurring Between Application and Incorporation

Application Strategy	Weather Conditions				
	Average	Cool-wet	Cool-dry	Warm-wet	Warm-dry
Surface applied, incorporated within 1 day ¹	0.75	0.90	0.85	0.75	0.50
Surface applied, incorporated within 2 days	0.70	0.87	0.81	0.69	0.43
Surface applied, incorporated within 3 days	0.65	0.85	0.78	0.62	0.35
Surface applied, incorporated within 4 days	0.60	0.83	0.74	0.56	0.28
Surface applied, incorporated within 5 days	0.55	0.80	0.70	0.50	0.20
Not incorporated	0.34	0.60	0.50	0.25	0.00
Injected	1.00	1.00	1.00	1.00	1.00
Cover crop ²	0.65	0.75	0.25	0.40	0.50

¹ Use these factors for broadcast liquid manure (without incorporation) on bare soils.

² Use these factors for broadcast liquid manure (without incorporation) on land with residue, such as direct-seeded fields or forages.

Created by Matt Oryschak, 2006

Retention Factors for Broadcast Liquid Manure

The retention of $\text{NH}_4\text{-N}$ in broadcast liquid manure is dependent on the ability of manure to infiltrate into the soil. Once in the soil, NH_4 molecules adsorb to soil particles, reducing risk of loss. In situations where there is ground cover, some of the broadcast manure will coat crop residues and remain exposed to the air, increasing the potential for losses.

Using these correction factors, retained $\text{NH}_4\text{-N}$ in manure is calculated as:

$$\text{Retained } \text{NH}_4\text{-N} = \text{NH}_4\text{-N} \times \text{Retention Factor (from Table 4.3.4)}$$

The estimated crop-available N content of the manure is then calculated as:

$$\text{Estimated Crop Available N} = \text{Available Organic N (year 1)} + \text{Retained } \text{NH}_4\text{-N}$$



Estimating Crop Available N

Swine manure (1.8 kg/1000 L of $\text{NH}_4\text{-N}$) is to be surface applied using a splash plate application system on a soil under conventional tillage. This situation is assumed to be similar to surface application and incorporation within one day. Since application is planned over a period of several days, and the weather conditions during this period are expected to be quite variable, an average retention factor of 0.75 is used.

$$\begin{aligned} \text{Retained } \text{NH}_4\text{-N} &= \text{NH}_4\text{-N} \times \text{Retention Factor (Table 4.6.3)} \\ &= 1.8 \text{ kg/1000 L} \times 0.75 \\ &= 1.35 \text{ kg/1000 L} \end{aligned}$$

Available organic N content for the year of application is:

$$\begin{aligned} \text{Available Organic N} &= \text{Organic N} \times 0.25 \\ &= 1.7 \text{ kg/1000 L} \times 0.25 \\ &= 0.425 \text{ kg/1000 L} \end{aligned}$$

The total amount of crop available N in this manure then is:

$$\begin{aligned} \text{Estimated Crop Available N} &= \text{Available Organic N (year 1)} + \text{Retained } \text{NH}_4\text{-N} \\ &= 0.425 \text{ kg/1000 L} + 1.35 \text{ kg/1000 L} \\ &= 1.78 \text{ kg/1000 L} \end{aligned}$$

Calculating Available N in Compost

Nitrate concentration is usually very low in raw manure, but can be present in higher concentrations in compost. For composted material, a nitrate analysis should be requested. If compost contains detectable amounts of $\text{NO}_3\text{-N}$, this should be subtracted along with any $\text{NH}_4\text{-N}$ from total N to estimate organic N content. Any NO_3 present should be included in the estimate of crop available N, together with retained $\text{NH}_4\text{-N}$ and available organic N.

To calculate organic N content, subtract the $\text{NO}_3\text{-N}$ and $\text{NH}_4\text{-N}$ from total N:

$$\text{Organic N} = \text{Total N} - \text{NH}_4\text{-N} - \text{NO}_3\text{-N}$$

Because properly composted manure is a more stable source of organic N, less N will be mineralized. It is safe to assume that 13 percent of organic N will be mineralized to crop-available forms in the year following application:

$$\text{Available Organic N (year of application)} = \text{Organic N} \times 0.13$$

Additional organic N will be mineralized in subsequent years and can be estimated at 7 % in year 2 and 4 % in year 3 when planning future manure applications.

$$\text{Available Organic N (year 2)} = \text{Organic N} \times 0.07$$

$$\text{Available Organic N (year 3)} = \text{Organic N} \times 0.04$$

To calculate crop available N, add $\text{NO}_3\text{-N}$ to retained $\text{NH}_4\text{-N}$ and percentage of organic N that will become available.

$$\text{Estimated Crop Available N} = \text{Available Organic N (year 1)} + \text{Retained NH}_4\text{-N} + \text{NO}_3\text{-N}$$

Crop Available P

Similar to N, P in manure is present in organic and inorganic forms, but most labs only report the amount of total P in a sample. Based on experience and research, about 70% of total P in manure will be crop available in the year it is applied:

$$\text{Estimated Crop Available P (year 1)} = \text{Total P} \times 0.7$$

Similar to N, some of the residual applied P will be mineralized and become crop available in subsequent years:

$$\text{Estimated Crop Available P (year 2)} = \text{Total P} \times 0.2$$

$$\text{Estimated Crop Available P (year 3)} = \text{Total P} \times 0.06$$





Estimating Crop Available P

The total P content of a liquid manure sample is reported to be 1.1 kg/1000 L.

The estimated amount of crop available P is:

Estimated Crop Available P (year of application)

$$\begin{aligned}
 &= \text{Total P} \times 0.7 \\
 &= 1.1 \text{ kg/1000L} \times 0.7 \\
 &= 0.77 \text{ kg/1000 L}
 \end{aligned}$$

Estimated Crop Available P (year 2)

$$\begin{aligned}
 &= \text{Total P} \times 0.2 \\
 &= 1.1 \text{ kg/1000L} \times 0.2 \\
 &= 0.22 \text{ kg/1000 L}
 \end{aligned}$$

Estimated Crop Available P (year 3)

$$\begin{aligned}
 &= \text{Total P} \times 0.06 \\
 &= 1.1 \text{ kg/1000L} \times 0.06 \\
 &= 0.07 \text{ kg/1000 L}
 \end{aligned}$$

Approximately 0.77 kg/1000 L of P will become available to the crop in year of application (year 1). An estimated additional 0.22 kg/1000 L of P will come available to the crop in the first year after application (year 2) and 0.07 kg/1000 L of P will come available to a crop in the second year after application (year 3).

Crop Available K

Unlike other nutrients, manure K exists exclusively in the crop available inorganic K^+ form. Research suggests that about 90% of manure K is effectively crop available:

$$\text{Estimated Crop Available K} = \text{Total K} \times 0.9$$



Estimating Crop Available K

The total K content of a liquid manure sample is reported to be 1.7 kg/1000 L.

The estimated amount of crop available K is:

$$\begin{aligned}
 \text{Estimated Crop Available K} &= \text{Total K} \times 0.9 \\
 &= 1.7 \text{ kg/1000 L} \times 0.9 \\
 &= 1.53 \text{ kg/1000 L}
 \end{aligned}$$

Crop Availability of Other Nutrients in Manure

The crop availability of sulphur, calcium, magnesium and micronutrients is of less concern. When manure application rate is based on either N or P, other nutrients will likely be applied at rates several times higher than agronomic requirements, or what would be necessary to correct soil deficiencies.

Other Parameters

Manure tests may provide other information about the manure including pH and EC. Neither parameter has clear implications for manure application, since the relationship between manure and soil pH and EC are not well defined.

If C:N ratio is provided for the manure, it can provide a sense of how rapidly and to what extent nutrients will become available from the manure. In general, the lower the C:N ratio the more rapidly organic nutrients will be released in crop available forms.

Net mineralization of organic N occurs when C:N is less than 20:1. When C:N exceeds 30:1, N becomes a limiting nutrient for decomposer organisms, and this can reduce the rate of decomposition and results in N immobilization (i.e., N tie-up). This can be an issue in manure with large amounts of bedding mixed in, such as poultry litter or certain types of beef manure. In these situations, requesting a C:N ratio from the lab may be valuable for identifying potential issues with N availability.

Similar to N, organic forms of P are mineralized by soil microorganisms to inorganic forms, but can also be immobilized depending on the ratio of carbon to P (C:P ratio). The C:P ratio can be estimated:

$$\text{C:N ratio} \times \text{Total N} \div \text{Total P} = \text{C:P ratio}$$

When the C:P ratio in residues is between 200:1 and 300:1, mineralization and immobilization balance each other to result in no net release of P from the decomposing manure. When C:P is below this range, P is released, while above this range P will be tied up and not released for crop use.

Nitrate-N levels are typically higher in finished compost than fresh manure. Most inorganic N in fresh manure is in the $\text{NH}_4\text{-N}$ form but nitrification during the composting process converts some of this to $\text{NO}_3\text{-N}$. The ammonium-N/nitrate N ratio is often used as an index of compost maturity with lower ratios denoting more mature or stable material. Ratios fall from 1000:1 for fresh manure to <10:1 for compost.

summary

- It may be necessary to convert units appearing on the lab report. Use the conversions in Table 4.3.3 to convert between units.
- Organic N content of manure is estimated as the difference between total N and ammonium N content.
- For fresh manure assume that 25% of the organic N will become available in the year of application, 13% the following year and 6% the year after that. For composted manure assume that 12% of the organic N will become available in the year of application, 7% the following year and 4% the year after that.
- Crop available N in manure is equal to the sum of available organic N in the year of application and retained ammonium N content of the manure.
- Assume that 70% of total P is available in the year of application, 20% the following year and 6% the year after that. Assume that 90% of K is available.
- Neither EC or pH have clear implications for manure application, since the relationship between manure and soil pH and EC are not well defined.
- A measure of C:N ratio in manure can be useful for identifying potential N availability issues in manure containing substantial amounts of bedding.
- Nitrate concentration is usually very low in raw manure, but can be present at higher concentrations in compost. Any $\text{NO}_3\text{-N}$ should be factored into the estimate of crop available N.

Chapter 4.4

Manure Application and Alberta's *Agricultural Operation Practices Act (AOPA)*

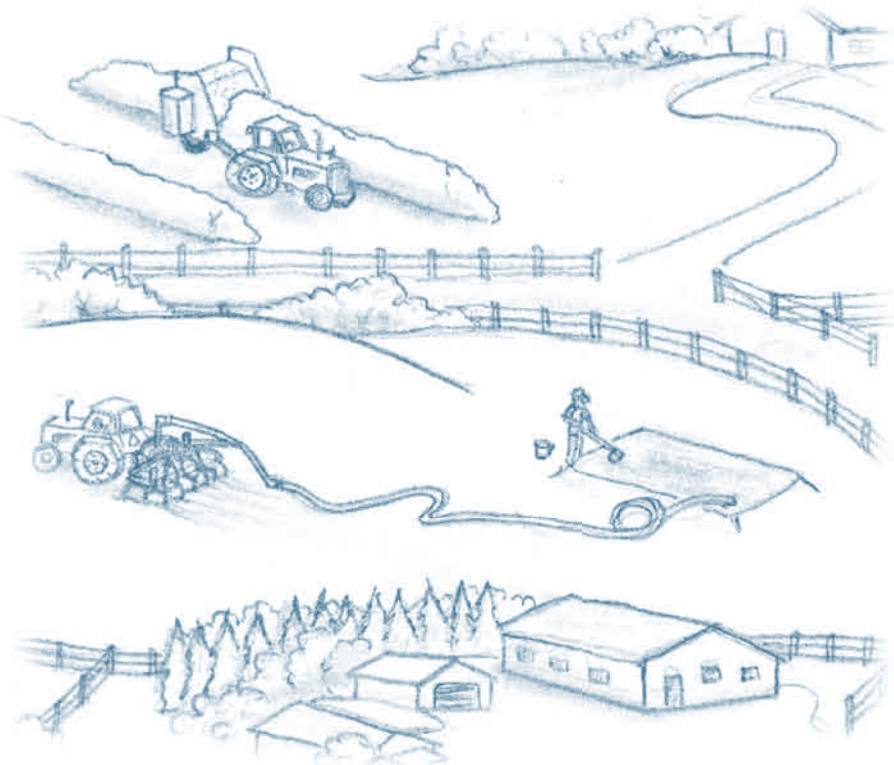

➔ learning objectives

- Identify manure incorporation requirements required by AOPA.
- Identify minimum setback distances for manure application required by AOPA.
- Identify soil nitrate-nitrogen limits prescribed by AOPA that may restrict manure application.
- Identify soil salinity restrictions on manure application prescribed by AOPA.

more info



You can get more information on AOPA or answers to specific

questions, by calling the nearest **NRCB office (see below) or at www.nrcb.gov.ab.ca.**

NRCB: Toll-free 24-hour response line 1-866-383-6722. Dial 310-000 first for toll-free connection

Lethbridge (403) 381-5166

Red Deer (403) 340-5241

Morinville (780) 939-1212

Fairview (780) 835-7111

side bar

Manure can only be applied to arable land.

Important Terms

Table 4.4.1 Key Terms and Definitions

Term	Definition
Common Body of Water	Is considered in the legislation (AOPA) as the bed and shore of a water body that is common to or shared by more than one landowner.
Manure	Under AOPA manure includes the livestock excreta, straw, other bedding material, litter, soil, wash water and feed in the manure. Composted manure has the same requirements as manure.
Natural Resources Conservation Board	(NRCB) It is a regulatory agency of the Government of Alberta. It is responsible for regulating Alberta's confined feeding operations.

AOPA contains the majority of regulations that impact livestock production in Alberta. AOPA is maintained and updated by AF, and the administration and enforcement of the Act resides with the NRCB.

AOPA includes several rules pertaining to manure application with particular reference to:

- Incorporation requirements
- Minimum setback distances for manure that is applied and incorporated
- Minimum setback distances for manure applied on forage, direct-seeded crops, and frozen or snow-covered land
- Nitrate-nitrogen limits
- Salinity constraints
- Nutrient management plans
- Manure handling plans

Incorporation Requirements

Under AOPA, manure applied to land under traditional cultivation must be incorporated within 48 hours of application. The exception to this rule is when manure is applied to forages, direct-seeded crops, frozen or snow-covered land or when an operation has a permit that specifies a different incorporation requirement. Liquid manure injection is considered to be the same as incorporation.

Incorporating manure soon after it has been applied will reduce odour. From an agronomic perspective, incorporation reduces losses of manure nutrients through volatilization or runoff; thereby retaining a greater proportion of applied nutrients for crop uptake. Incorporation can be accomplished satisfactorily using typical tillage implements (e.g., cultivator).

Minimum Setback Distances for Manure that is Applied and Incorporated

Individuals who apply manure are required to comply with application setback distances set by AOPA (Figure 4.4.1). These setback distances are designed to reduce nuisance impacts on neighbours and minimize the risk of manure entering a common body of water. Specifically, manure is not to be applied:

- Within 30 metres of a water well, regardless of whether it is injected or surface applied and incorporated.
- Within 10 metres of a common body of water if subsurface injection is used.
- Within 30 metres of a common body of water if manure is surface-applied and incorporated within 48 hours.

Note: There is no setback requirement from neighbouring residences if manure is spread on cultivated land and incorporated within 48 hours.

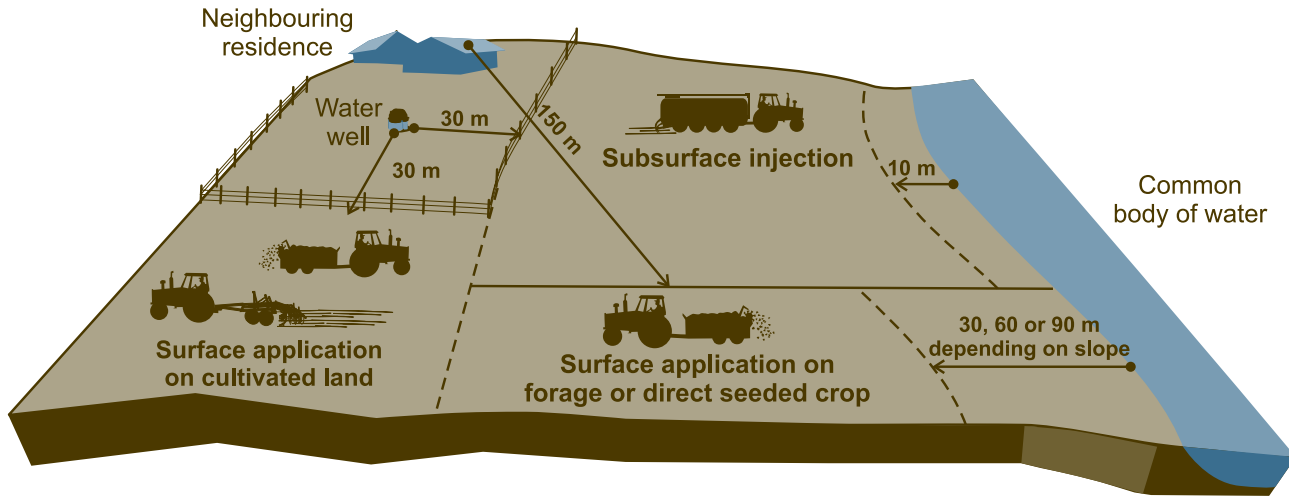

Figure 4.4.1 Summary of Manure Application Setback Distances Prescribed Under AOPA

sidebar

Grazing livestock are not subject to setback requirements.



What is a “Common Body of Water”?

The term “common body of water” in the legislation includes the bed and shore of a water body that is common to or shared by more than one landowner. A “common body of water” can include a river, stream, creek, lake, slough, marsh, reservoir, irrigation or drainage canal.

As a general rule, features not considered to be a “common body of water” under AOPA are:

- An irrigation or drainage canal that is completely surrounded by private land controlled by the owner or operator and has no outflow going beyond the private land.
- A reservoir, lake, marsh, or slough that is completely surrounded by private land controlled by the owner or operator and has no outflow going directly beyond the private land

to a drainage canal, reservoir, river, permanent stream or creek, lake or potable water source that is being used for human or livestock consumption.

- A temporary stream on private land controlled by the owner or operator that has no outflow going beyond the private land directly to a drainage canal, reservoir, river, permanent stream or creek, lake or potable water source that is being used for human or livestock consumption.
- A roadside ditch.
- A wastewater or storm drainage system as defined in the *Environmental Protection and Enhancement Act (EPEA)*.

sidebar

Manure application on frozen or snow-covered land is not a recommended beneficial management practice.

tip



As a courtesy, producers are encouraged to notify their neighbours before spreading manure to reduce complaints and conflict associated with manure application.

tip



Even if setbacks are met, reasonable care and attention should be taken to reduce the amount of manure that may enter common bodies of water as a result of snowmelt runoff.



Minimum Setback Distances for Manure applied on Forage, Direct-Seeded Crops, and Frozen or Snow-Covered Land

An operator whose Confined Feeding Operation (CFO) has at least nine months of manure storage is prohibited from applying manure to frozen or snow-covered ground. The legislation recognizes that there may be exceptional circumstances that create the need for operators to spread manure on snow or frozen ground. This practice may be allowed with permission from an NRCB inspector, or if the Board publishes a notice permitting the application of manure on frozen and snow-covered land. Livestock operations and CFOs constructed before January 1, 2002, that do not have nine months of storage can continue to spread on frozen and snow-covered ground, **but** they must comply with the various setbacks and soil nutrient limits in the regulations.

Manure application on frozen or snow-covered land is not a recommended beneficial management practice. In Alberta more than 85% of the runoff comes from snowmelt. Application of manure on snow-covered or frozen ground increases the risk of nutrient transport from the field to neighbouring water bodies.

If manure must be applied to frozen or snow-covered land, from a beneficial management point of view, there are several considerations that can be made to reduce the risk of nutrient runoff:

- Have an emergency plan in place, as part of the operation, to deal with the development of situations that would require the application of manure on snow-covered or frozen ground.
- As part of the operation plan, assess the risks associated with various fields or parts of fields to determine their suitability for the application and to minimize the risk of nutrient loss through runoff.

- On selected fields establish structural controls (i.e., berm or catch basin) or management practices (i.e., standing stubble) to reduce the risk of runoff.
- Choose a field that does not border or drain into a common body of water
- Apply manure to the centre areas of the field that do not drain off of the field
- Limit the frequency and rate of application to a minimum.

Manure application on forage, direct-seeded, and frozen or snow-covered land has specific setback requirements. Manure that is spread and not incorporated must be spread at least 150 metres from any residence, other building or occupied structure that is not owned by the operator (including churches and schools). An example of buildings or structures not occupied by people includes granaries and hay storage sheds.

A person who applies manure on forage, direct-seeded and frozen or snow-covered land must meet minimum application setback distances, keeping mind the average slope of the land near the common body of water, if the land slopes toward the common body of water (Table 4.4.2 and Figure 4.4.2). When planning manure applications, setback distances impact the available area in a field, and therefore limits the amount of manure that can be applied to that field. Specific practices and controls to reduce nutrient losses from runoff are discussed in Module 8.0.

Slopes in a field, particularly those adjacent to a common body of water, should have been characterized during the site assessment. For the purposes of AOPA, measuring the slope over the first 90 metres from the edge of the water body is sufficient.

Table 4.4.2 Setback Distances from a Common Body of Water for Manure Application on Forage, Direct-seeded and Frozen or Snow-covered Land

Average slope within 90 meters of a common body of water	Setback distance required from the common body of water
4% or less	30 m
Greater than 4% to less than 6%	60 m
6% or greater, but less than 12 %	90 m
If the slope is 12% or greater, do not apply manure on the land. Once the slope is less than 12% manure can be applied.	

Setbacks for manure application on land with less than 12% slope (on forage, direct-seeded crops, frozen or snow-covered land)

4% slope or less

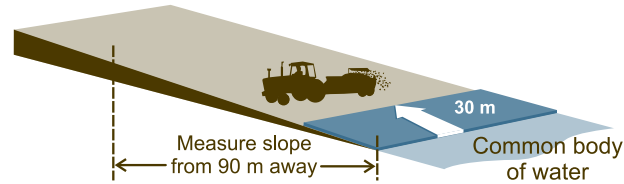

4 - 6% slope

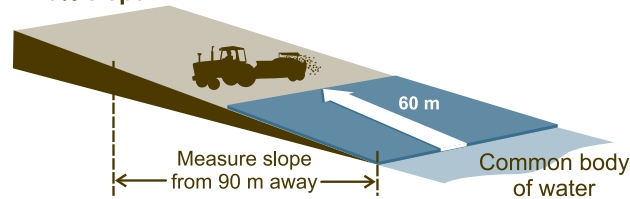

6 - 12% slope

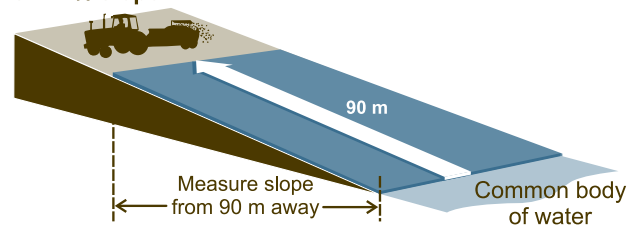

Setbacks for manure application on land with 12% slope or greater (on forage, direct-seeded crops, frozen or snow-covered land)

✓ Manure can only be applied once the slope is less than 12%.

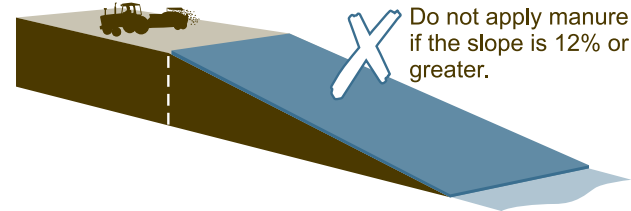

Figure 4.4.2 Slope-based manure application setback distances from common bodies of water on forage or direct seeded land.

Soil Nitrate-Nitrogen Limits

Under AOPA, soil NO₃-N limits have been set for the top 60 cm of soil. The maximum allowable level depends on productive potential of the soil group, soil texture, depth to water table and soil type (Table 4.4.3).

Table 4.4.3 Soil Nitrate-N Limits for Agricultural Soils in Alberta

Soil	Soil Texture		
	Coarse Textured Soils (i.e., > 45% sand)		Medium and Fine Textured Soils
	Depth to Water Table < 4m	Depth to Water Table > 4m	
Brown	80 kg/ha	140 kg/ha	140 kg/ha
Dark Brown	110 kg/ha	140 kg/ha	170 kg/ha
Black	1-40 kg/ha	170 kg/ha	225 kg/ha
Gray Wooded (Gray Luvisol)	110 kg/ha	140 kg/ha	170 kg/ha
Irrigated	180 kg/ha	225 kg/ha	270 kg/ha

Adapted from: Schedule 3, Standards and Administration Regulation, 2006

sidebar

To convert the values from Table 4.4.3 from kg/ha to lb/ac, multiply by 0.89.

sidebar

The following examples may help as a guide in determining the slope of the land:

- 4% slope is equal to a 3.6 m rise over a 90 m horizontal distance
- 6% slope is equal to a 5.4 m rise over a 90 m horizontal distance
- 12% slope is equal to a 10.8 m rise over a 90 m horizontal distance

more info



For more information on the record keeping requirements and forms can be found in the following resources:

www.agric.gov.ab.ca

www.nrcb.gov.ab.ca

- **AF. 2004. Wintering sites and livestock corrals, Agdex 096-4.**
- **AF. 2005. Manure management regulations for cow/calf producers, Agdex 096-6.**
- **AF. 2005. Manure spreading regulations, Agdex 096-5.**
- **AF. 2006. Permits and regulations for existing operations, Agdex 096-2.**
- **AF. 2007. AOPA: 2004 Reference Guide, Agdex# 096-1.**

Salinity Constraints

AOPA also sets limitations on manure application based on soil salinity, to ensure the salts in manure do not affect plant growth. Manure may not be applied at rates that, if after application, would result in a one decisiemens/metre (dS/m) increase in EC in the top 15 cm (6 in) of the soil. Manure application is prohibited on soils, if the EC of the soil in the top 15 cm is greater than four dS/m.

Currently, there is no simple and reliable way of predicting the extent to which a one-time application of manure is likely to impact soil EC at a given site. Regular soil sampling is the most reliable way to assess and monitor changes in soil salinity. It is important to identify saline areas during the site assessment since these areas may reduce the total area available for manure application.

NMPs Under AOPA

NMPs are **not mandatory for every person who applies manure**. Under AOPA, an approved NMP is required if a person wants to exceed the soil nitrate-nitrogen or salinity limits when applying manure. The NRCB can approve a NMP for applying manure in excess of the limits if the NRCB is satisfied that implementing the NMP will not adversely affect the soil or the environment.

Manure Handling Plans under AOPA

A person applying for a CFO permit can submit a manure handling plan to the NRCB for approval to reduce or eliminate the need to meet the manure application and storage requirements under AOPA. The NRCB may approve a manure handling plan that provides an alternative to complying with the manure application and storage requirements. For example, an operation may submit a manure handling plan where an agreement is in place with others who will be accepting the manure from the operation. Manure production and transfer records must also be kept in these situations.



→ summary

- AOPA requires that manure be incorporated within 48 hours of application, unless manure is applied to forages, direct-seeded, frozen or snow covered land.
- Manure may not be applied within 30 metres of a well.
- Manure application adjacent to common bodies of water requires a setback distance of 10 metres if injected and 30 metres if surface applied and incorporated within 48 hours.
- In situations where manure cannot be incorporated, manure may not be applied within 150 metres of a residence or other building or structure occupied by people, and the application setback distances from water bodies increases with slope grade (minimum 30 m).
- Under AOPA, manure application rates are restricted based on $\text{NO}_3\text{-N}$ in the top 60 cm of soil. The maximum allowable level depends on soil texture, depth to water table and soil type.
- Manure may not be applied if its application would result in a one dS/m increase in EC in the top 15 cm (6 in) of the soil.
- Manure may not be applied to soil if the soil EC, prior to application, is more than four dS/m. Regular soil sampling as part of a nutrient management plan is the most reliable way to assess and monitor changes in soil salinity.

Chapter 4.5

Manure Application Equipment

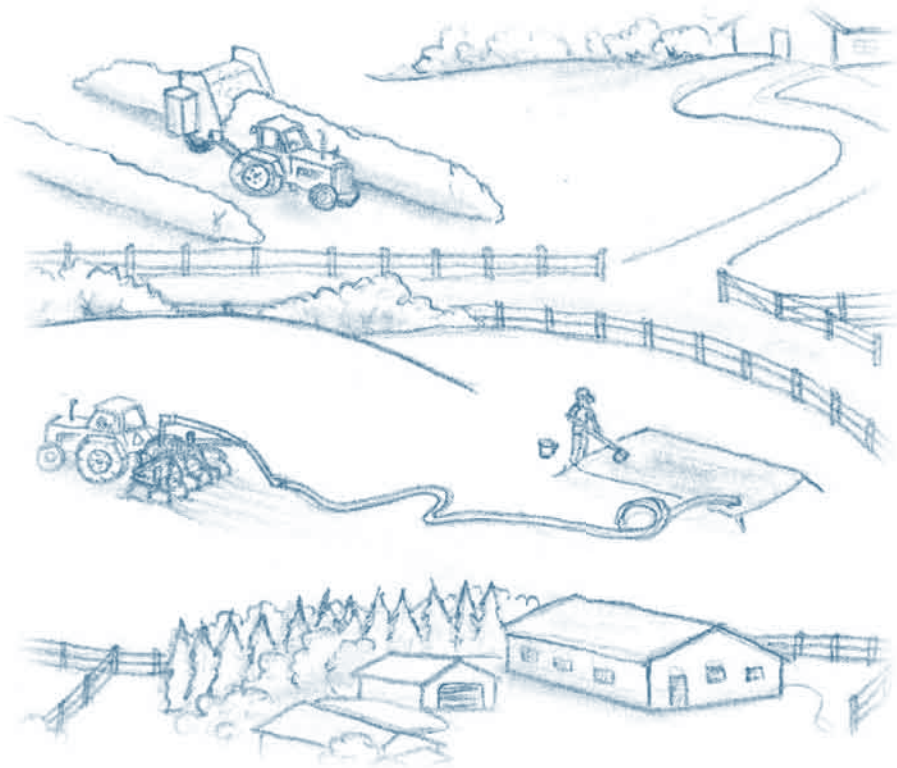

➔ learning objectives

- Describe common application systems for liquid and solid manure.
- Characterize the performance of several systems with regards to manure placement, ammonium conservation, odour nuisance, soil compaction and timeliness of application.

Important Terms

Table 4.5.1 Key Terms and Definitions

Term	Definition
Drag-hose, Dragline or Umbilical Applicator	A liquid manure application system where the application unit (e.g., cultivator) is connected to the manure storage lagoon by a long hose. A pump moves the manure down the hose to the cultivator where it is incorporated or broadcast.
Drop Tube or Drop Hose Applicator	A liquid manure applicator that uses a series of hoses, fitted along a boom at the back of the unit. These hoses apply manure beneath the crop canopy, closer to the soil surface and thereby reduce ammonia loss and odour and improve application uniformity.
Injection	The term is used to describe manure application methods that place the manure directly into the soil, in the same field operation as application.
Manifold	A chamber having several outlets through which a liquid or gas is distributed or gathered.
Opener	A tool used for opening or disturbing the soil such as discs, cultivator shovels or narrow knives.
Splash Plate	A liquid manure tank spreader that pumps the manure from the tank on to or into a metal plate (the splash plate) that deflects the manure creating an application pattern.

There are several options available for applying manure. It is important to recognize that the application system used has several implications for nutrient management, in particular nutrient placement and retention.

In many situations, producers may not have much choice as to the application method or equipment available. The trend in Alberta is towards using custom applicators and, therefore, the choice of application equipment and method is limited to those offered by the contractor. Time constraints and contractor availability often means that manure application happens when it fits into the schedule rather than when ideal weather conditions present themselves.

This chapter will summarize key features of different application options, so that strengths and limitations of each are more clearly understood.

Manure Application Systems

Liquid Manure

Liquid manure (less than 12% solids) can be surface applied or directly injected using a number of different systems, which are changing and improving rapidly. Liquid manure is typically stored under anaerobic conditions, which alters decomposition processes and the resulting end products. The result is that liquid manure tends to produce more odour than solid manure. Odour and related nuisance concerns have been the driver for improvements in liquid manure application technology. Injection systems, drag-hose equipment, and other methods of limiting the exposure of the manure to the air have partially alleviated the odour problems. At the same time, these application methods reduce nutrient loss, and therefore, preserve the fertilizer value of manure.

Tank spreader systems are the most common systems used to apply liquid manure in Alberta (Figure 4.5.1). In warmer and wetter parts of the U.S., irrigation equipment is also frequently used to apply liquid manure.



Figure 4.5.1 Examples of Common Liquid Manure Application Equipment

Manure injection involves the use of ground openers, such as discs, cultivator shovels or narrow knives (Figure 4.5.3). Typically, the openers are mounted on a tool bar and a manifold directs manure streams close to the openers, usually just behind them.



The Importance of Agitating Liquid Manure

During storage, liquid manure tends to settle into different layers within the facility, each with a distinct nutrient profile. By agitating liquid manure, solids are disrupted and re-suspended, which facilitates storage emptying and improves the consistency (i.e., nutrient distribution) of the manure applied.

Liquid manure can be agitated using various types of high volume pumps or propeller-type agitators (Figure 4.5.2). If the storage facility is large, it may be necessary to place agitators at several locations to get adequate mixing. Often the same pump can be used to agitate and load applicators.

more info



Additional information on drag-hose manure injection systems can be found in the following online publication:

Prairie Agriculture Machinery Institute and AF. 1997. A guide to pipeline manure injection systems. Research update 729. [www1.agric.gov.ab.ca/\\$department/deptdocs.nsf/all/eng9868](http://www1.agric.gov.ab.ca/$department/deptdocs.nsf/all/eng9868)

more info



To get more information about sprinkler and irrigation application systems for manure, consult the following online resource:

Koelsch, R. and Humenik, F. Not dated. Selecting the appropriate land application method. Lesson 36 in Livestock and poultry environmental stewardship curriculum. www.lpes.org/Lessons/Lesson36/36_1_Selecting_Application.pdf

sidebar

Potentially lethal gases such as hydrogen sulphide (H_2S) are released when liquid manure is disturbed. Take special care to ensure adequate ventilation when there are people or animals present, and never enter **a confined space where manure is present** without a respirator.



Figure 4.5.2 Example of a pump used to agitate liquid manure prior to application.

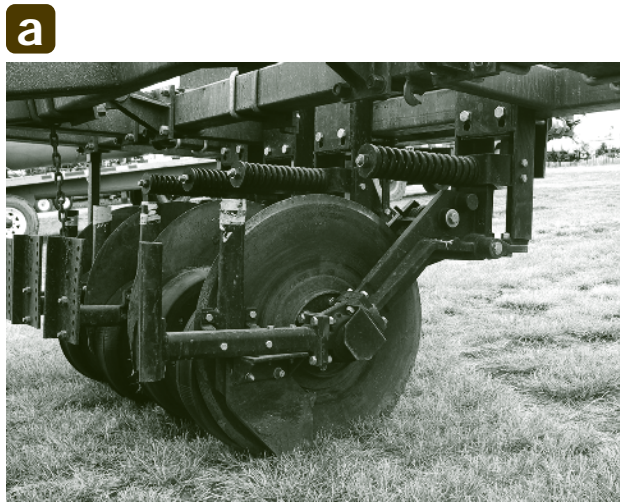

Figure 4.5.3 Four Types of Openers Available to Inject Liquid Manure. (a) Yetter disk opener (b) Sweep opener (c) Knife or Spike opener.

Solid Manure

Most solid manure (20% or more solids) and compost is spread using broadcasting equipment (Figure 4.5.4), followed by tillage to incorporate the manure into the soil. Delayed incorporation can result in increased odour, risk of nutrient loss in runoff and volatilization losses of manure nitrogen.

Truck-mounted box spreaders improve travel times from storage to field compared to trailer-mounted spreaders, which affects the length of time required to apply stockpiled manure. Soil compaction can be a problem, but is usually reduced by using dual or flotation tires, or by simply delaying application until field conditions are dry.



Figure 4.5.4 Examples of Common Solid Manure Application Equipment

Manure Incorporation and AOPA

Under AOPA, anyone who applies manure or compost (including composting material) must incorporate within 48 hours of application, except those who are applying manure to forage, direct-seeded crops, frozen or snow-covered ground. Manure or compost may be applied without incorporation in these situations, provided that application is at least 150 m from a residence or regularly occupied building.

Solid Manure Injection?

The University of Saskatchewan and the Prairie Agricultural Machinery Institute (PAMI) have designed a rear discharge box spreader that can spread solid manure and compost more evenly than present equipment. They are presently testing additional components, such as a flexible auger delivery system, that one day may make it possible to simultaneously incorporate solid manure during application.

You can visit PAMI online at: www.pami.ca; and the University of Saskatchewan, Department of Agricultural and Bioresource Engineering at: www.engr.usask.ca/dept/abe/.

more info



Specialists with AF recently completed an evaluation of several liquid manure injection technologies, which looked at characteristics such as manure placement, soil and residue disturbance, draft requirements and odour emissions. An executive summary of the study is available from the **AF publications office**, or downloaded from Ropin' the Web.

- **AF. Liquid manure injection technologies: Performance evaluation. Agdex 743-1.**

Download the complete project report from Ropin' the Web.

- **AF. 2005. Performance evaluation of five liquid manure injection technologies. [www1.agric.gov.ab.ca/\\$department/deptdocs.nsf/all/agdex10096/\\$FILE/743-1_report.pdf](http://www1.agric.gov.ab.ca/$department/deptdocs.nsf/all/agdex10096/$FILE/743-1_report.pdf)**



Key Features of Manure Application Equipment

Five important criteria can be used to compare performance of application equipment:

- Manure placement
- Nitrogen conservation
- Potential for odour nuisance
- Soil compaction
- Timeliness of manure application

The performance of selected application systems in relation to these characteristics is summarized in Table 4.5.2

Table 4.5.2 Performance¹ of Selected Application Systems for Each of the Five Characteristics Discussed

Application system	Uniformity of Application	Ammonium N Conservation	Odour Control	Soil Compaction	Timeliness of Application
<i>Solid spreading systems</i>					
Box spreader (tractor-pulled)	F	VP	F	F	P
Box spreader (truck-mounted)	F	VP	F	F	F
<i>Liquid spreading systems</i>					
Liquid tank spreader (with splash plates)	P	P	P	P	F
Liquid tank spreader (with drop hoses)	F	F	G	P	F
Liquid tank spreader (with knife injectors)	G	E	E	P	F
Liquid tank spreader (with shallow incorporation)	G	E	E	P	F
Drag-hose system (with shallow incorporation)	G	E	E	G	G

¹ VP = Very Poor, P = Poor, F= Fair, G = Good, E = Excellent

From Koelsch, R. and Humenik, F. Not dated.

Manure Placement

The goal of all application systems is to apply manure in an acceptable pattern where crops will have the greatest access to manure nutrients. When manure is applied and left exposed on the surface, nutrients in the manure are vulnerable to loss through volatilization. Immobile nutrients (potassium and phosphorus) will remain in the top layers of soil, making them largely unavailable to the crop, and more susceptible to loss through runoff. Ideally, manure should be injected or incorporated soon after application (Figure 4.5.5). This reduces the risk of nutrient losses and improves crop access to manure nutrients.









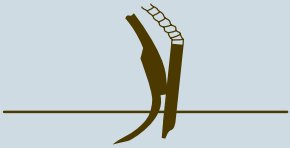
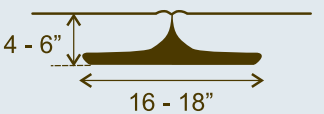

Row Crop Application Method	Placement of Manure (not to scale)	Application Implement (side views)
<p>A. Injection: vertical knife/chisel</p>		
<p>B. Injection: horizontal sweep</p>		
<p>C. Shallow incorporation: s-tine cultivator (staggered)</p>		
<p>D. Shallow incorporation: concave disks</p>		
<p>E. Injection: slot injection</p>		
<p>F. Surface application: aeration technology</p>		
<p>G. Injection: offset disk slot injection</p>		

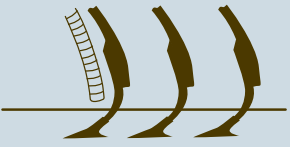

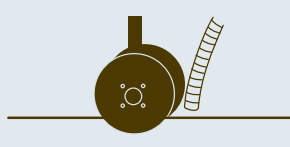
Figure 4.5.5 Placement of Manure Using Different Application Implements

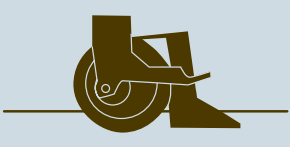
Adapted from Jokela and Cote 1994

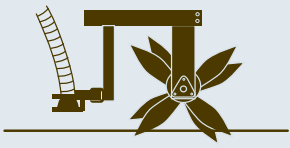

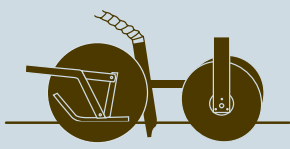
Manure placement can also be looked at in terms of the uniformity of spread, which will be discussed in more detail in the next chapter. Achieving a uniform distribution of manure will help to ensure that nutrients are applied uniformly to the field. Uniform application will help prevent nutrient deficiencies that may result in uneven crop growth. If operated properly, most application systems, with the exception of liquid tank spreader systems equipped with splash plates, will provide acceptable application uniformity (Table 4.5.2).

Nitrogen Conservation

The predominant form of crop available N in many manures is ammonium ($\text{NH}_4\text{-N}$), which is prone to loss through volatilization. The amount of $\text{NH}_4\text{-N}$ lost is a function of the application and incorporation strategy (both the method and relative timing) and the weather conditions during application (Table 4.5.3).

Application systems that get manure into the soil as soon as possible after application minimize the opportunity for $\text{NH}_4\text{-N}$ to volatilize. Warm and dry conditions favour greater volatilization compared to wet and cool conditions. Application strategies that help retain $\text{NH}_4\text{-N}$ will maintain the fertility value of applied manure and therefore, the economic value of the manure.

Potential for Odour Nuisance

Odour is the principle nuisance concern associated with manure application. Generation and emission of odours from manure is a complex process, but in general, application systems that minimize manure contact with air have fewer odour concerns (Table 4.5.2). For example, liquid application systems where manure is deposited directly on or into the ground (i.e., drop tubes and injection) will produce less odour compared to liquid application systems with splash plates. To minimize odour problems, incorporate manure either during or as soon after application as possible.

Soil Compaction

Field equipment weighed down by large volumes of manure may increase the risk soil compaction (Table 4.5.2). The risk is further aggravated if manure is applied in late fall or early spring when soils have higher soil moisture and are more vulnerable to compaction. Where possible, avoid applying manure at times when fields are most vulnerable to compaction. Alternatively consider using systems with a lower risk of compaction, such as drag-hose systems for liquid manure. Refer to Chapter 8.2 for additional ways that soil compaction can be minimized.

Timeliness of Manure Application

CFOs produce large volumes of manure that is typically applied only once or twice per year. Depending on the capacity of equipment, the application rate and the distance of the application area from the storage facility, manure application can take days or even weeks.

Any system that must return to the storage facility to be refilled will take the longest to apply stored manure (Table 4.5.2). Systems that use an intermediary, such as a nurse tank that transports manure from the storage facility to the application field and allows the applicator to stay in the field, will require less time. Liquid drag-hoses are the most time efficient application system because manure is continuously pumped from the storage to the applicator in the field.

A system's ability to get manure out into the field in a timely manner will save the operation money in labour and equipment costs. There is also the opportunity to minimize nutrient losses and nuisance (odour and transportation).

Table 4.5.3 Expected Ammonium Nitrogen Loss (in percent) in Relation to Application Method, Timing and Weather Conditions.

Application and Incorporation Strategy	Weather Conditions During Application				
	Average	Cool-Wet	Cool-Dry	Warm-Wet	Warm-Dry
Surface applied, incorporated within 1 day ¹	25 %	10 %	15 %	25 %	50 %
Surface applied, incorporated within 2 days	30 %	13 %	19 %	31 %	57 %
Surface applied, incorporated within 3 days	35 %	15 %	22 %	38 %	65 %
Surface applied, incorporated within 4 days	40 %	17 %	26 %	44 %	72 %
Surface applied, incorporated within 5 days	45 %	20 %	30 %	50 %	80 %
Not incorporated	66 %	40 %	50 %	75 %	100 %
Injected	0 %	0 %	0 %	0 %	0 %
Cover crop ²	35 %	25 %	25 %	40 %	50 %

¹ These percentages would also apply to liquid manure broadcast (without incorporation) on bare soils.

² These percentages would also apply to liquid manure broadcast (without incorporation) on land with residue, such as direct-seeded fields or forages.

Adapted from AF 2004.



➔ summary

- Liquid manure is either surface applied or injected using tank spreader or drag-hose application systems using several different ground openers.
- Solid manure is typically surface applied using box spreader systems.
- In order to minimize odour and nutrient losses, surface applied manure should be incorporated as soon as possible.
- With the exception of liquid tank spreaders equipped with splash plates, most commonly used application systems will provide acceptable application uniformity when used properly.
- Manure application systems that apply manure to the surface are associated with greater odour concerns and poorer ammonium N conservation. **Ammonium N losses are influenced by the interval** between application and incorporation, as well as climatic conditions.
- To minimize soil compaction, avoid applying manure when soils are most vulnerable to compaction. Alternatively, consider using systems with a lower risk of compaction, such as drag-hose application systems.
- All systems with boxes or tanks that must **be refilled increase the length of time it** takes to apply manure. **Liquid drag-hoses are the most time efficient system because** manure is continuously pumped from the storage to the applicator.

Chapter 4.6

Calibrating Manure Application Equipment

➔ learning objectives

- Describe two methods for calibrating manure application systems and situations where each is preferred.
- Determine the appropriate spacing between spreader passes to obtain uniform coverage with the manure.
- Explain how to achieve a desired application rate using the information generated from a calibration.
- Explain why calibration curves are useful for application equipment with multiple settings.

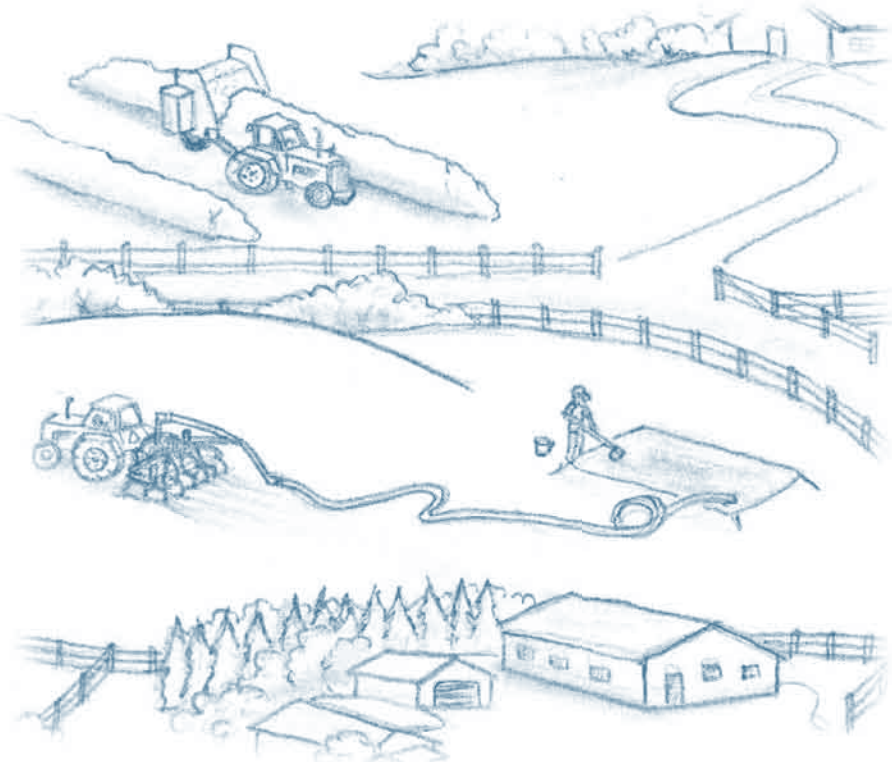

tip



Water can be used as an alternative source to liquid manure for the initial calibration of manure applicators. This approach is cleaner and will provide a relatively accurate calibration. Some fine tuning of the equipment may be required when liquid manure is being applied.



Important Terms

Table 4.6.1 Key Terms and Definitions

Term	Definition
Calibration	To check, adjust, or determine by observation or testing the rate or volume of manure being applied by a piece of equipment.
Corrected Target Speed	The target application speed of a spreader, that has been corrected to account for differences in density between the manure to be applied versus the manure used during the equipment calibration.
Effective Spreader Width	This is the spreading width that an implement can apply manure at a uniform application rate. An application pass one 'effective spreader width' from the last should provide an ideal application overlap that will result in a relatively uniform application.
Gross Weight	The total weight without deduction for tare or waste.
Net Weight	The weight of actual goods (manure), excluding container, wrapper or tarp; also called actual.
'Reference' Application Rate	Used to determine an application speed for a targeted application rate based on material with a difference in bulk density.
'Struck Load'	Is the volume contained in the level-full box. The volumetric capacity of spreaders may be given as a typical "heaped" load condition or as a "struck" load condition.
Tare Weight	The empty or clean weight of a container, wrapper or tarp.

To be able to apply manure at desired rates it is important to know the performance capabilities of application equipment. While manufacturers provide some basic specifications about the equipment, such as dimensions or capacity, seldom is any information provided about application rates.

Calibrating application equipment provides important information about what rates are possible with a particular piece of equipment, and also the speed (and settings) that can be used to achieve target application rates. There are two calibration techniques:

- The load-area method involves estimating the weight or volume of manure in a loaded spreader and then determining the area required to spread an entire load (or several loads).
- The weight-area method involves weighing the manure spread over a known area to calculate the rate at which the manure was applied.

A calibration technique should be selected based on the application equipment being used and the type of manure

being applied. If liquid manure is injected, use the load-area method since injected manure cannot be collected. Surface applications of liquid, solid or compost manure should be calibrated using the weight-area method.

Load-Area Calibration

The load-area calibration technique involves measuring the volume of manure in a typical load and the area required to spread the load at constant speed and applicator settings. Dividing volume in the load by the area used to spread the load will yield the application rate for that speed and setting. It may take several loads to cover a known area. In this case the total volume applied will need to be divided by the known area.

This technique requires a note pad, a calculator and flags or stakes to mark off the boundaries of the calibration test area. The distance between markers can be estimated by counting the number of paces between markers and multiplying this by the average distance traveled in a pace.

Follow the steps below to use the load-area technique to calibrate application equipment.

1. Determine the Capacity of the Manure Spreader

Manufacturer’s specifications will usually include the capacity of the spreader. However, for solid spreaders the capacity reported is often for a level or ‘struck’ load. If using heaped loads or if capacity of the spreader is unavailable, the capacity of the spreader will need to be estimated (Figure 4.6.1).

The manufacturer’s capacity specification may need to be converted into units that are compatible with those on the manure test report and used to express the recommended application rate (Table 4.3.3, Chapter 4.3). Record the capacity (specified or estimated) of the spreader.

Volume in cubic metres or feet can be converted into litres or gallons using the conversion factors in Table 4.6.2.

Table 4.6.2 Factors to Convert Between Measures of Volume

Start Units:	Multiply start units by factors in the appropriate column to get:				
	ft ³	m ³	L	US gal	Imp gal
Cubic feet (ft ³)		0.0283	28.32	7.481	6.229
Cubic metres (m ³)	35.31		1000	264.2	220.0
Litres (L)	0.0353	0.001		0.2642	0.2200
US gallons (US gal)	0.1337	0.0038	3.785		0.8327
Imperial gallons (Imp gal)	0.1605	0.0045	4.546	1.201	

Tank Spreaders

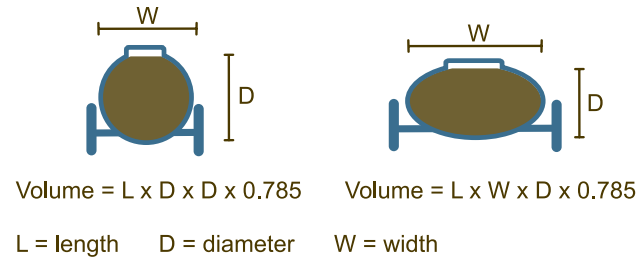

Figure 4.6.1 Volume Calculations for Various Manure Application Equipment.

sidebar

To determine the average distance traveled in a single pace, measure the distance traveled in 10 normal paces and divide by 10.





Calculating the Capacity of a Liquid Tank Spreader

A non-round tank spreader has a length of 8.5 m, a width of 3.75 m and diameter of 2.5 m. The volume of the spreader is:

$$\begin{aligned} \text{Volume (m}^3\text{)} &= 8.5 \text{ m} \times 3.75 \text{ m} \times 2.5 \text{ m} \times 0.785 \\ &= 62.55 \text{ m}^3 \text{ is the volume of the spreader} \end{aligned}$$

To convert this volume into litres:

$$\begin{aligned} \text{Spreader Volume (L)} &= \text{Spreader Volume (m}^3\text{)} \times 1000 \text{ L/m}^3 \\ &= 62.55 \text{ m}^3 \times 1000 \text{ L/m}^3 \\ &= 62,550 \text{ L is the volume of the spreader} \end{aligned}$$

2. Spread Manure on Calibration Test Area

While maintaining constant speed, spread the load (or loads) of manure on a calibration test area. To achieve uniform coverage with the manure, make passes with application equipment one-spreader width from the centre of adjacent passes.

3. Measure the Calibration Test Area

Use flags, stakes or some other reliable marker to mark out the boundaries of the calibration test area where the test loads of manure were spread. Measure the distances between the markers and calculate the area (in m² or ft²). The area covered by the test load(s) of manure can be converted to hectares (or acres):

$$\text{Calibration Test Area (ha)} = \text{Calibration Test Area (m}^2\text{)} \div 10,000 \text{ m}^2/\text{ha}$$

$$\text{Calibration Test Area (ac)} = \text{Calibration Test Area (ft}^2\text{)} \div 43,560 \text{ ft}^2/\text{ac}$$



Measuring the Calibration Test Area

Three loads of manure were spread onto a rectangular test area with a width of 92 m and a length of 205 m. The estimated area covered by the three test loads of manure is:

$$\begin{aligned} \text{Calibration Test Area (m}^2\text{)} &= 92 \text{ m} \times 205 \text{ m} \\ &= 18,860 \text{ m}^2 \text{ is the estimated area covered by the test loads} \end{aligned}$$

To convert this to hectares:

$$\begin{aligned} \text{Calibration Test Area (ha)} &= 18,860 \text{ m}^2 \div 10,000 \text{ m}^2/\text{ha} \\ &= 1.89 \text{ ha is the calibration test area} \end{aligned}$$

4. Calculate Application Rate

To calculate the application rate, multiply the estimated volume of manure applied by the number of loads applied and then divide by the area covered by the test loads:

$$\text{Application Rate} = (\text{Volume per Spreader Load} \times \text{Number of Loads}) \div \text{Calibration Test Area}$$



Calculating Application Rate

The volume of manure per spreader load is 62,550 L and the calibration test area covered by three loads of manure applied at a given speed was 1.89 ha. The application rate is calculated as:

$$\begin{aligned} \text{Application Rate (L/ha)} &= (\text{volume (L/load)} \times \text{number of loads}) \div \text{calibration test area} \\ &= (62,550 \text{ L/load} \times 3 \text{ loads}) \div 1.89 \text{ ha} \\ &= 187,650 \text{ L} \div 1.89 \text{ ha} \\ &= 99,286 \text{ L/ha is the application rate} \end{aligned}$$

Calculating Application Rate for a Dragline System

Dragline application systems are slightly easier to calibrate since application rate can be determined using the flow rate, the width of application and ground speed of the applicator. The application rate in a dragline system is calculated as:

$$\begin{aligned} \text{Application Rate (L/ha)} &= \\ &[\text{Flow rate (L/min)} \times 60 \text{ min/h} \times 10000 \text{ m}^2/\text{ha}] \div [\text{Speed (km/h)} \times 1000 \text{ m/km} \times \text{Width of application (m)}] \end{aligned}$$

Or,

$$\begin{aligned} \text{Application Rate (gal/ac)} &= \\ &[\text{Flow rate (gal/min)} \times 60 \text{ min/h} \times 43560 \text{ ft}^2/\text{ac}] \div [\text{Speed (mi/h)} \times 5280 \text{ ft/mi} \times \text{Width of application (ft)}] \end{aligned}$$

The conversion factors in the top and bottom lines of each equation are necessary so that the units in the calculation are compatible. The desired application rate can be achieved through altering any of the factors in the equation. Note that this strategy also works for other liquid application systems where flow rate can be manipulated.

s i d e b a r

If sheets or pans are used for several runs, the tare weight must be determined before each run to account for any residual manure remaining.

tip



Tarps are convenient for the purposes of collecting solid manure since they are easily secured to the ground, inexpensive, easy to clean, and typically come in standard dimensions. Long, shallow, plastic home organization boxes, though somewhat more costly, are equally convenient for liquid manure calibrations.



Achieving Target Application Rate in a Dragline System

The example below only shows the values for each of the known factors, since the units in this equation (particularly those of the conversion factors) can become confusing.

The target application rate for a field is approximately 13,000 L/ha. The field conditions dictate that ground speed should not exceed 6 km/h. The application width of the dragline system is approximately 4.9 m. The flow rate that would be required to achieve an application rate of 13,000 L/ha would be:

$$\text{Application Rate (L/ha)} = \frac{\text{Flow Rate (L/min)} \times 60 \text{ min/h} \times 10,000 \text{ m}^2/\text{ha}}{\text{Speed (km/h)} \times 1,000 \text{ m/km} \times \text{Width of application (m)}}$$

$$\text{Flow Rate (L/min)} = \frac{\text{Application Rate (L/ha)} \times \text{Speed (km/h)} \times 1,000 \text{ m/km} \times \text{Width of application (m)}}{60 \text{ min/h} \times 10,000 \text{ m}^2/\text{ha}}$$

$$= \frac{13,000 \text{ L/ha} \times 6 \text{ km/h} \times 1,000 \text{ m/km} \times 4.9 \text{ m}}{60 \text{ min/h} \times 10,000 \text{ m}^2/\text{ha}}$$

$$= \frac{382,200,000}{600,000}$$

$$= 637 \text{ L/min is the flow rate}$$

Weight-Area Calibration

The weight-area calibration technique directly measures the weight of manure delivered to a known area at a given speed and setting. This is then used to determine the application rate in t/ha (or tn/ac).

This technique requires one or more plastic sheets, tarps or collection trays; means for securing these in place (e.g., pegs, weights); a suitable scale to weigh the manure collected; a tape measure; a notepad and a calculator. Weighing can be made easier by having a large plastic pail or garbage can on hand.

Follow the steps below to use the weight-area technique to calibrate application equipment.

1. Prepare the Collection Sheets or Pans

Use either a single large sheet, or several smaller sheets installed side by side, spanning the equivalent of twice the spreader width to collect solid manure. If using a single long sheet, divide the sheet evenly into sections using paint, tape or another suitable method. Ensure that the total area covered by the collection sheets or pans is at least 9 m² (100 ft²). For liquid manure use a series of strategically placed shallow pans (Figure 4.6.2). For best results, use a minimum of 8 to 10 pans for the calibration.

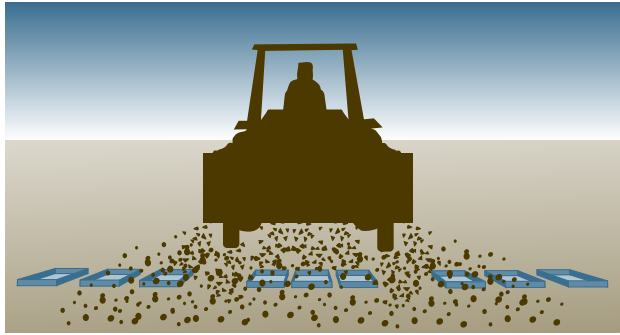

Figure 4.6.2 Sample Layout Pattern for Sheets or Pans

Determine the total collection area by multiplying length by width of each sheet or pans and then multiplying by the number of sheets or pans that will be used during the calibration. If the intention is to weigh manure directly on sheets or pans, pre-weigh the sheets or pans and record the empty or clean weight (i.e., tare weight) of each. Record the total collection area and the tare weight for each collection sheet or pan.

2. Secure Collection Sheets or Pans

Lay out collection sheets or pans in the desired pattern, across the equivalent of two spreader widths. If using several sheets, space them evenly or secure them side-by-side. Stretch sheets out to remove any wrinkles and secure to the ground using pegs or some other method. This will prevent them from being moved by wind or wheel pressure from the equipment passing over.

Since pans can be easily crushed by equipment, space the pans to allow space for equipment tires to pass in between. Marking out the spreader's path can help prevent collection pans from being crushed.

3. Make a First Pass with the Spreader

Perform a single pass with the spreader directly through the middle of the test area. Begin spreading prior to

reaching the test area to ensure the spreader is fully functional while passing over the collection pans or sheets.

4. Weigh Manure Collected

Weigh the manure collected either by directly weighing the sheet or pan with manure or by transferring the manure to a container that is easier to handle. Containers, such as a large plastic garbage can for solid manure, or a pail for liquid manure can be used for this purpose. Remember to weigh and record the weight of the container prior to beginning to establish a tare weight that can be subtracted from the gross weight. If using a single collection sheet, weigh the manure collected in each marked off section.

Use a scale that is appropriate for the specific situation. If using small sheets or pans to collect solid or liquid manure, either a kitchen (for less than 2 kg or 5 lb) or bathroom scale (up to 25 kg or 50 lb) is suitable. If collecting solid manure on larger sheets, a spring-tension scale or milk scale (more than 25 kg or 50 lb) might be more appropriate.

Remember that the weight that registers on the scale is the total weight of the manure plus the container. Subtract the tare weight of the sheet, pan or container to get the net weight of manure collected. Record the net weight of manure collected.

5. Calculate Application Rate

To calculate application rate in kg/m² (or lb/ft²), divide the total net weight of manure collected in kg (or lb) by the area of the sheet(s) or pans in m² (or ft²). To convert this rate to t/ha (or tn/ac) use the conversions below:

Application rate (t/ha) = Application rate (kg/m²) × 10

Application rate (tn/ac) = Application rate (lb/ft²) × 21.78

sidebar

Take special care to avoid spilling manure as this can affect the calibration considerably.



Calculating Application Rate

A series of six evenly spaced, 1.5 m² tarps, collected a total of 16.2 kg of solid manure. The resulting application rate is:

$$\begin{aligned}\text{Total Collection Area (m}^2\text{)} &= 1.5 \text{ m}^2/\text{tarp} \times 6 \text{ tarps} \\ &= 9 \text{ m}^2\end{aligned}$$

$$\begin{aligned}\text{Application Rate (kg/m}^2\text{)} &= \text{Weight of collected manure (kg)} \div \text{Total collection area (m}^2\text{)} \\ &= 16.2 \text{ kg} \div 9 \text{ m}^2 \\ &= 1.8 \text{ kg/m}^2\end{aligned}$$

$$\begin{aligned}\text{Application Rate (t/ha)} &= \text{Application rate (kg/m}^2\text{)} \times 10 \\ &= 1.8 \text{ kg/m}^2 \times 10 \\ &= 18 \text{ t/ha}\end{aligned}$$

Determining Spacing Between Spreader Passes

When using surface application systems, a uniform application can be achieved by adjusting the spacing between adjacent passes with the spreader so that the passes overlap. The spacing between passes that will result in the most uniform application can be determined by graphing the outcome of the first spreader pass.

Using graph paper, plot application rates on a graph where application rate (or discharge) is on the vertical axis and distance of the center of the collection pan, sheet or sheet section from the center of the spreader path is on the horizontal axis (Figure 4.6.3). Connect the data points with a line to develop a uniformity curve.

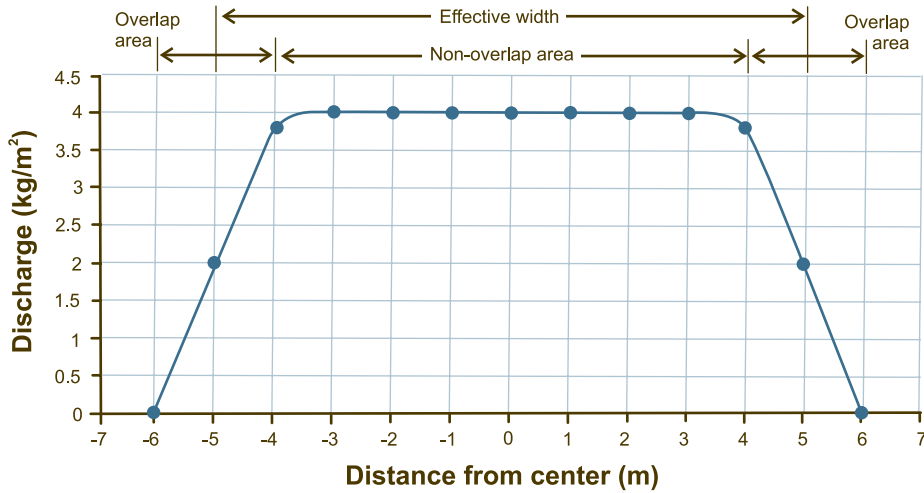

Source: B.C. Ministry of Agriculture, Forestry and Lands, 2005

Figure 4.6.3 Sample Application Uniformity Curve Generated from the Results of a Uniformity Test

The ideal spacing between spreader passes is equal to the effective spreader width. Using the graph, identify the horizontal distances to the left and right of the center where the application rate fell to 50 percent of the maximum observed during the test. The distance between these two points on either side of center is the effective spreader width. Spacing the passes one effective spreader width from the last should provide an ideal application overlap that will result in a relatively uniform application.

Verifying Application Rate and Spreader Pass Spacing

Once again, spread manure at the same speed and setting over the test area where sheets or pans are laid out, only this time make three passes. Spread the first pass directly over the center of the collection area. Make the remaining two passes, one effective spreader width to the left and right of the center of the first pass.

Weigh the manure collected and calculate the application rate for each of the pans, sheets or sheet sections across the width of the test area. If the spacing between spreader passes is correct the application rate across the width of the test area should be relatively consistent. If application rates appear to be heavier in between spreader passes, this suggests that the spreader passes should be made further apart. Conversely, if application rates are noticeably lighter in between, spreader passes should be moved closer together.

Record the average application rate across the width of the test area, the speed and setting (if applicable) used during the calibration. If applying solid manure the density of the manure should be recorded as well. This information can be used to quickly recalculate applications speeds and setting if manure with a different density is to be applied with the same machine and is discussed in the following section.





Using Calibration Results to Plan Manure Applications

Calibrating will provide an application rate that was achieved when travelling at a constant speed and equipment settings. Altering the travel speed of the spreader according to the relationship below will change the application rate:

Desired Application Rate

$$= \text{Calibration Test Speed} \times \text{Calibration Application Rate} \div \text{Target Speed}$$

This equation can be rearranged to yield the target speed to achieve the desired application rate:

Target Speed

$$= \text{Calibration Test Speed} \times \text{Calibration Application Rate} \div \text{Desired Application Rate}$$

If applying solid manure, a correction must be made for differences in density between the manure to be applied versus the manure used during the calibration:

Corrected Target Speed

$$= (\text{Calibration Test Speed} \times \text{Calibration Application Rate} \times \text{Present Manure Density}) \div (\text{Desired Application Rate} \times \text{Calibration Manure Density})$$



Calculating Ground Speed to Achieve a Target Application Rate

A calibrated solid spreader was found to apply manure with a density of 923 kg/m³, at a rate of 12.5 t/ha when traveling at a speed of 4 km/h. The target application rate for a field is 9 t/ha. The travel speed necessary to apply manure with a density of 794 kg/m³ at a rate of 9 t/ha using the calibrated setting for this applicator is:

Corrected Target Speed (km/h)

$$\begin{aligned} &= (4 \text{ km/h} \times 12.5 \text{ t/ha} \times 794 \text{ kg/m}^3) \div (9 \text{ t/ha} \times 923 \text{ kg/m}^3) \\ &= (39,700) \div (8,307) \\ &= 4.8 \text{ km/h is the approximate corrected target speed} \end{aligned}$$

Developing Calibration Graphs

Spreaders with multiple settings (e.g., PTO-driven) offer the advantage of being able to achieve multiple application rates through variable setting and ground speed combinations to accommodate field conditions. Considerable time can be saved in the future by developing calibration “curves” for each of the settings on the spreader. To do so, use the following procedure:

1. Use either the load-area or weight-area method to determine the application rate at a low and high speed for a specific setting (if applicable). Record the density of manure used during the calibration (for solid manure), the setting (e.g., PTO speed) and the travel speed of the spreader.
2. On a piece of graph paper, plot the application rate for the setting at low and high speeds on a graph with application rate on the vertical axis and speed on the horizontal axis (Figure 4.6.4).

3. Draw a straight line to connect the data points corresponding to the application rates at low and high speeds. This line is the calibration curve for that particular setting.
4. Repeat steps 1 through 3 for each available setting for the spreader.

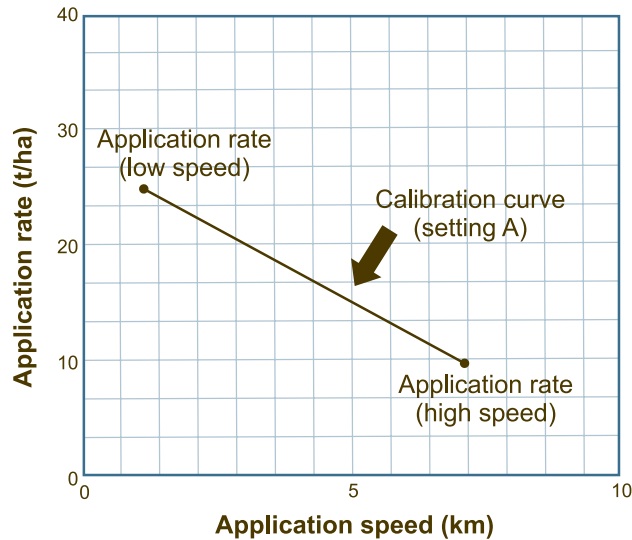

Figure 4.6.4 Sample Calibration Graph for a Manure Spreader

Once lines have been graphed for each of the settings, they can be referred to in the future when using this equipment. For each target application rate, identified along the vertical axis of the graph, a corresponding equipment setting and speed can be selected (Figure 4.6.5). Building a calibration graph is time consuming, but in the long run the overall benefit of the calibration graph is that it will save time. The calibration graph can be quickly referenced so that manure application rates, equipment settings and travel speeds can be adjusted to meet a variety of field conditions.

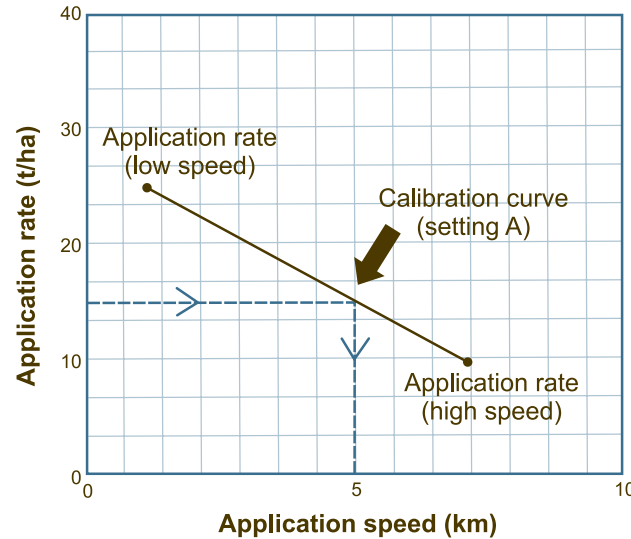

Figure 4.6.5 Identifying the Travel Speed from a Calibration Line.

Adjusting for Differences in Manure Density

Basically, if lower density manure is being applied, a higher travel speed is required to apply an equivalent amount of material that has a higher density. A calibration graph for a solid manure spreader, calibrated for a specific density of material can be used to determine the correct traveling speed for application of material with a different density.

If the density of the manure changes, the actual application rate can be derived from the vertical axis of the calibration graph by using the following equation.

‘Reference’ Application Rate

= Desired Application Rate (for the un-calibrated manure to be applied) x (Calibration Manure Density ÷ Density of Manure to be Applied)

tip



Completing this process can be very beneficial to custom manure applicators who are dealing with a variety of different types and densities of manure.





The equation will determine the manure ‘reference’ application rate that must be looked up, along the vertical axis of the calibration graph. A straight line can be drawn horizontally from this ‘reference’ application rate to the calibration line, for a given setting (Figure 4.6.6). From this identified point on the calibration line a vertical line can be drawn down identifying the travel speed, which will be required to achieve the desired application rate for the different density material.

For example, if the calibration curve was developed for manure with a density of 0.9 t/m³ and the manure to be applied had a density of 0.45 t/m³, the application rate of the new manure would have to be doubled in order to put on an equivalent amount of material. To double the application rate the application speed will have to be cut in half or settings adjusted. The calibration line can be used to determine the application speed needed to apply the desired rate of the lighter material.

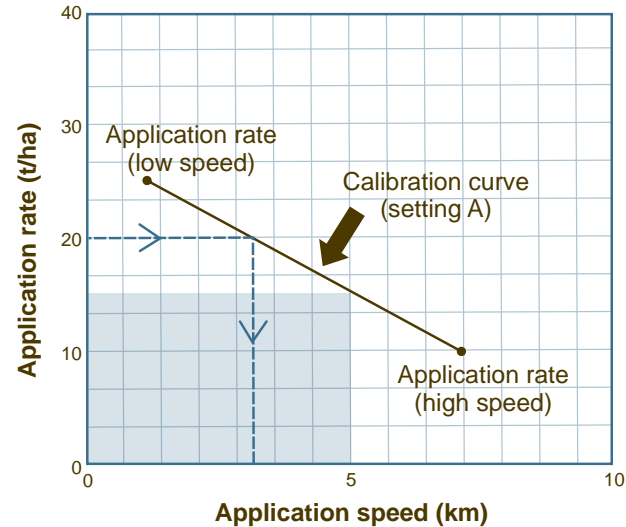

Figure 4.6.6 Using ‘Reference’ Application Rate to Determine Appropriate Application Speed.



Correcting Application Rate for New Manure Density in Order to Use an Existing Calibration Graph

A calibration graph for a solid manure spreader was based on cattle manure with a density of 0.72 t/m³ (Figure 4.6.6). Sheep manure with a density of 0.56 t/m³ is to be applied at a rate of 16 t/ha using the same spreader.

The ‘reference’ application rate needed to determine the appropriate speed using the existing calibration graph is calculated by:

‘Reference’ application rate (t/ha)

$$= 16 \text{ t/ha} \times (0.72 \text{ t/m}^3 \div 0.56 \text{ t/m}^3)$$

$$= 16 \text{ t/ha} \times (1.2857)$$

= 20.6 t/ha is the ‘reference’ application rate

The ‘reference’ application rate of 20.6 t/ha would be used on the vertical axis of the existing calibration graph to determine the appropriate speed for this particular applicator to apply the lighter sheep manure at a rate of 16 t/ha (Figure 4.6.6). This means that for this applicator to apply the lower density sheep manure, at a rate of 16 t/ha, this applicator would travel at the slower application speed needed as if it was applying 20.6 t/ha of the heavier cattle manure.

→ summary

- The load-area calibration is used for liquid manure injection systems and involves calculating the average area required to apply a single spreader load.
- The weight-area calibration involves weighing the amount of manure applied to a known area (usually plastic sheets, tarps or pans) and is used to calibrate surface application systems.
- Surface spreader passes should be approximately one effective spreader width apart to get relatively uniform coverage. Passes with injection equipment should be made immediately next to the previous.
- Altering the ground speed will change the application rate. If spreading solid manure, target ground speed must be corrected for differences in density between the manure to be applied and manure applied during the calibration.
- Calibration curves can be developed for spreaders with multiple settings by repeating the calibration for high and low speeds at each setting and graphing the results. This allows the selection of appropriate combinations of speed(s) and setting(s) to achieve a target application rate.

Chapter 5.1

Getting the Most Out of Commercial Fertilizer Applications

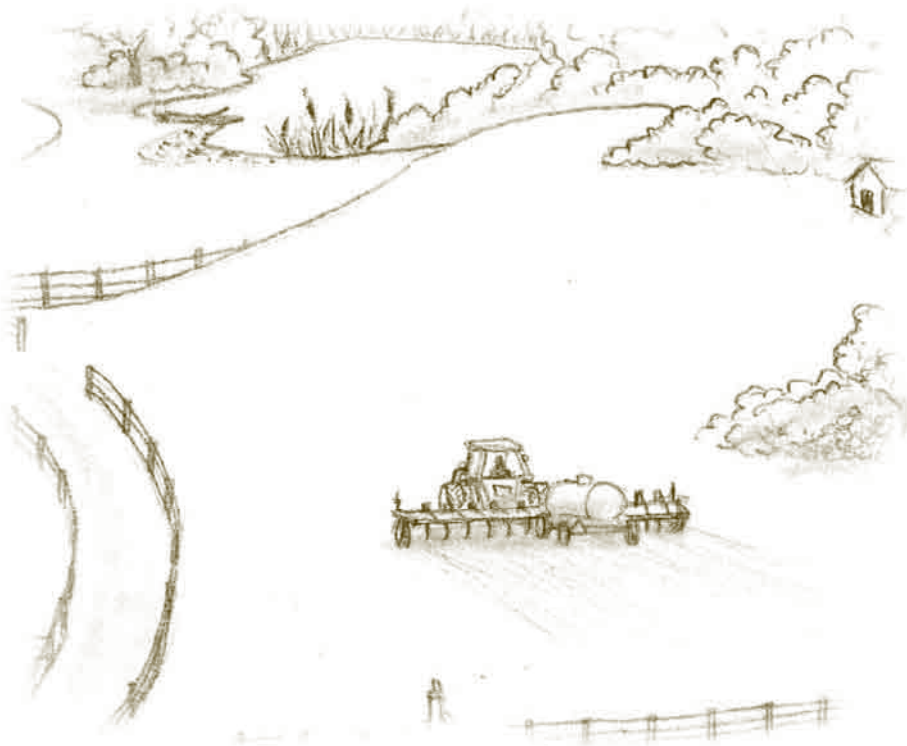

➔ learning objectives

- List five fertilizer placement methods and their impact on fertilizer effectiveness.
- List advantages and disadvantages of applying fertilizer in the fall, spring, and after crop emergence.



Important Terms

Table 5.1.1 Key words and Definitions

Term	Definition
Ammonia Toxicity	This occurs when the free ammonia ion (NH_3^+) is released when urea-N fertilizer converts to the ammonium form (NH_4^+). A high concentration of the free ammonia ion causes germination and seedling damage. Highly calcareous soils are more susceptible to ammonia toxicity than non-calcareous soils.
Banding	Any application method where the fertilizer is applied in concentrated strips, either on the surface or sub-surface.
Broadcast Application	Fertilizer applied on the soil surface.
Dribble Banding	Surface banding of liquid fertilizer.
Fertigation	Applying fertilizer using irrigation water and equipment.
Foliar Application	Applying liquid fertilizer to the leaf surface.
Knifing or “Knifing in”	Band application below the soil surface.
Broadcast and Incorporation	Incorporation of broadcast fertilizer using conventional tillage equipment.
Seed-Placed (in row)	Fertilizer placed in the same furrow as the seed.
Pre-Plant Application	Fertilizer application prior to seeding of the crop.
Salt Effect	The osmotic pressure or “pull” that fertilizers have on soil water. This osmotic pressure will prevent soil moisture, which is near the seed, from being accessed by the germinating seed and young seedling. This can be a major cause of germination and seedling damage. Salt effects are most severe when soil moisture is limited.
Seedbed Utilization (SBU)	The width of fertilizer and seed spread, relative to the row spacing, reflects the relative concentration of fertilizer in the seedrow. The higher the SBU, the more fertilizer that can safely be applied with the seed. For example a 7.5 cm spread with a 15 cm row spacing is 50% SBU ($7.5/15 \times 100 = 50\%$).
Side Banding	Fertilizer placed in a row near the seed during the one-pass seeding operation.
Side-Dressing	Fertilizer application in a row adjacent to the crop row.
Split Application	Fertilizer application is split into two or more applications.
Starter Fertilizer	Fertilizer applied when planting, usually in or near the seed row.

The balance of nutrients in manure does not match the nutrient requirements of crops. Strategic use of commercial fertilizers can address this imbalance by helping to optimize the use of manure nutrients and minimize the accumulation of nutrients (e.g., P) in soils that can occur with long-term, repeated applications of manure. As such, the judicious and efficient use of

commercial fertilizer is an environmentally responsible management practice.

This chapter will introduce important terms and concepts related to optimizing commercial fertilizer application including: fertilization, product placement methods, and the timing of commercial fertilizer applications.

Fertilizer Placement

The primary difference among fertilizer application techniques is where fertilizer is placed relative to the developing crop and its roots (Figure 5.1.1). This has implications for how effective the crop will be able to utilize certain nutrients.

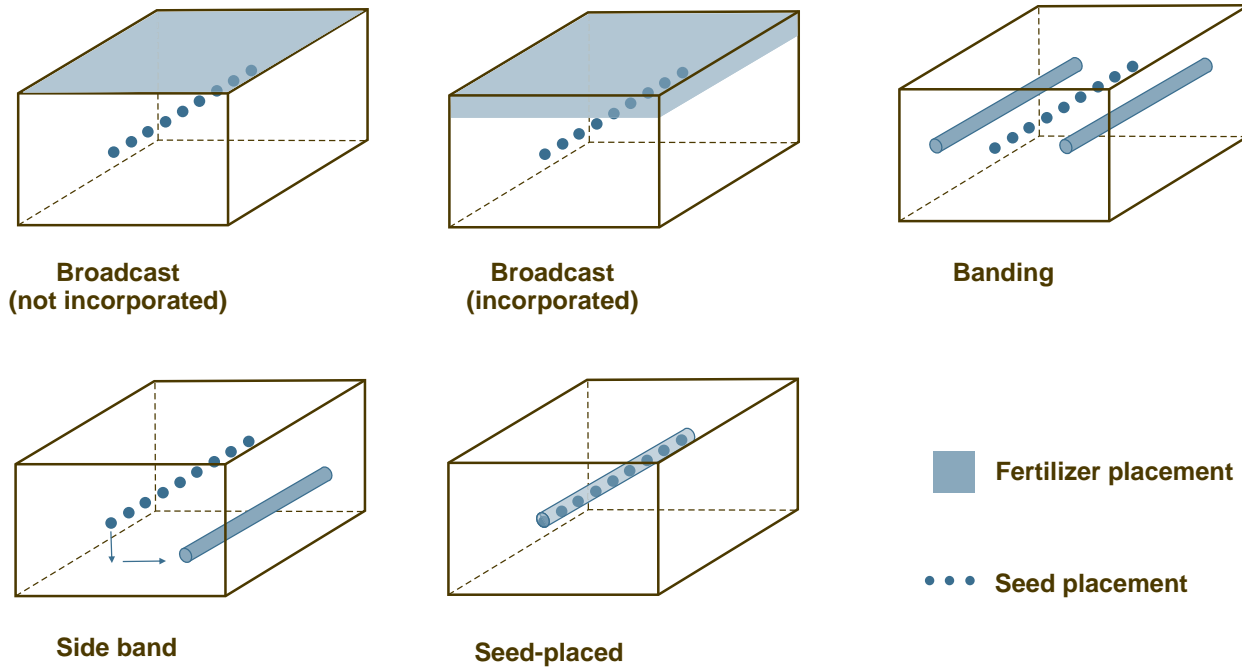

Figure 5.1.1 Placement of Fertilizer Using Different Application Techniques

Broadcast and Broadcast and Incorporation

Broadcasting spreads fertilizer across the soil surface. Broadcast fertilizer can be left on the soil surface or incorporated by a tillage operation after application. With incorporation, these nutrients are mixed into the surface layer of the soil where root interception is more likely to occur.

Broadcasting is generally the fastest and least costly fertilizer application method. On established crops it is usually the only practical way to apply fertilizer without damaging the crop. Elemental sulphur is particularly suited to broadcast applications because the granules

are left on the soil surface and exposed to weathering processes, which oxidizes the sulphur to plant available forms.

Broadcast fertilization has some limitations. Without adequate incorporation a portion of broadcast nitrogen fertilizers may volatilize and be lost to the atmosphere. Immobile nutrients (e.g., P, K, Cu) broadcast on the soil surface could be stranded above plant roots. These nutrients are inaccessible for root uptake or crop production and susceptible to loss through wind and water erosion, possibly ending up in environmentally



sensitive areas. Broadcasting, even with incorporation, mixes fertilizer with crop residue. As a result, microorganisms immobilize nutrients (primarily N) for weeks or months while they decompose the residue. Because of these limitations broadcasting is usually considered the least efficient way to apply most crop nutrients.



Seed-Placed

Seed-placed fertilizer refers to fertilizer placed within the seed row. It can be an effective placement method because the added nutrients are in close proximity to developing roots making them readily accessible to plants. This is especially important for immobile nutrients such as P and Cu.

There is no common nutrient loss process (e.g., volatilization or run-off) for seed-placed fertilizer. The problem with this method, however, is that fertilizer in the seed row can be harmful to seed, delaying or severely reducing crop emergence. This damage is due to ammonia toxicity or a salt effect from the fertilizer. The maximum fertilizer rate that can be safely placed in the seed row depends on the fertilizer used, crop type, soil moisture, and the width of spread of seed and fertilizer in the seed row (SBU). Urea (46-0-0) is the most damaging seed-placed fertilizer due to ammonia toxicity. Potash (KCl) and ammonium sulphate (20-0-0-24) are also problematic since these products induce a salt effect. Usually this is not as damaging as ammonia toxicity.

Band or Side Band

Banding is the application of fertilizer in a narrow row at seeding depth or slightly deeper. Banding can be done weeks or months prior to seeding, or during seeding depending on equipment. Side-banding refers to the

placement of fertilizer in a narrow row slightly to the side and below the seed row during the seeding operation. Banded and side-banded fertilizer applications have similar characteristics, and are both considered “banded” fertilizer. Mid-row banding places a row of fertilizer midway between two rows of seed, during the seeding operation. Side-banding and mid-row banding maintains a consistent distance between fertilizer and the seed, while fall banding or banding in a separate operation creates varying distances between fertilizer granules and the seed row.

Band placement is efficient for most fertilizers since the band is below the seed and roots will grow toward the fertilizer source. Banding creates a greater distance between seed and fertilizer, and this allows the opportunity to apply higher rates of fertilizer during seeding without a risk of ammonia toxicity and salt effect. For N, the narrow band of fertilizer is below crop residues so immobilization is not a factor. For P and K, the band has minimal soil contact and consequently little sorption occurs. There is no common nutrient loss process (e.g., volatilization or run-off) with spring banding.

Banding fertilizer may require an additional field operation and cost more because of additional energy requirements (e.g., fuel). Banding is not an effective placement for elemental sulphur because weathering and redistribution is limited.

Dribble banding refers to the application of liquid fertilizer in narrow strips on the soil surface before or after seeding. The effectiveness of dribble banding is more comparable to broadcasting than to banding fertilizer. Nutrient loss processes common to dribble banding and broadcasting include N volatilization and immobilization and P, K, and Cu stratification.

Getting the Best Results from Banding P Fertilizers

Here are some additional tips on successfully banding P fertilizers:

- Keep the spacing between bands narrow (less than 30 cm or 12 in), so P uptake is not delayed during early growth due to distance between bands and seedlings. On very low P soils stripping can occur. This is caused by poorer growth of plants midway between phosphate bands when the bands are too widely spaced.
- Band P fertilizer deep enough to avoid disrupting the bands during subsequent tillage and seeding operations.
- Avoid banding P and N fertilizers together if N is being applied at rates higher than 70 to 80 kg/ha (63 to 72 lb/ac). The high rate of N will reduce the efficiency of P fertilizers because plant roots cannot penetrate the concentrated N band and are less effective at taking up P.

Foliar

In foliar fertilization, nutrients are sprayed onto leaves, stems, and soil surfaces with conventional spraying equipment. Foliar applications are not effective for most nutrients (N, P, K, and S) because leaves cannot absorb enough nutrients for plant growth. Without rainfall or irrigation after application, foliar fertilizers are ineffective, and will only damage plants through fertilizer burn. Some forms of micronutrients are effective when foliar applied (Table 5.1.2).

Fertigation

Fertigation is the application of nutrients through irrigation water. It allows nutrients to be supplied throughout the growing season to meet crop demand. To be effective, nutrients should be delivered with a minimum of 1.5 to 2.0 cm of water to move the nutrients into the soil. Unlike foliar applications, fertilizer burn is not a problem with fertigation because of the amount of water that is applied.

If inadequate water is applied the fertilizer nutrients can be lost through volatilization or stranded at the soil surface out of reach of plant roots. Depending on the quality (hardness) of the water, precipitates (such as calcium phosphates) can form from the combination of fertilizer and cations in the irrigation water.





Table 5.1.2 General Micronutrient Application Guidelines

Nutrient	Fertilizer Form	Timing	Recommended Rate ¹ , kg/ha (lb/ac)			
			Broadcast and Incorporate	Banded	Seed-placed	Foliar
Copper (Cu)	Sulphate Oxysulphate	Spring or fall	3.9 to 5.6 kg/ha (3.5 to 5.0 lb/ac)	NR	NR	NR
	Oxysulphate	Fall	5.6 kg/ha (5.0 lb/ac)	NR	NR	NR
	Chelated	Spring	0.6 kg/ha (0.5 lb/ac)	NR	0.3 to 0.6 kg/ha (0.25 to 0.5 lb/ac)	0.2 to 0.3 kg/ha (0.2 to 0.25 lb/ac)
Zinc (Zn)	Sulphate Oxysulphate	Spring or fall	3.9 to 5.6 kg/ha (3.5 to 5.0 lb/ac)	NR	NR	NR
	Oxysulphate	Fall	5.6 to 11.2 kg/ha (5.0 to 10 lb/ac)	NR	NR	NR
	Chelated	Spring	1.1 kg/ha (1.0 lb/ac)	NR	NV	0.3 to 0.4 kg/ha (0.3 to 0.4 lb/ac)
Manganese (Mn)	Sulphate	Spring	56 to 90 kg/ha (50 to 80 lb/ac)	NR	4.5 to 22.4 kg/ha (4.0 to 20 lb/ac)	NR
	Chelated	Spring	NR	NR	NR	0.6 to 1.1 kg/ha (0.5 to 1.0 lb/ac)
Boron (B)	Sodium Borate	Spring	0.6 to 1.7 kg/ha (0.5 to 1.5 lb/ac)	NV	NR	0.3 to 0.6 kg/ha (0.3 to 0.5 lb/ac)

¹ Rates are in kg (or lb) of elemental Cu, Zn, Mn, and B per ha (or ac). NR = not recommended, NV = not verified.

Adapted from Barker, 2006

Timing of Application

The goal of applying fertilizer is to deliver nutrients to plants before or just as they are needed. In western Canada, fertilizers may be applied in the fall, in the spring prior to seeding, during seeding, or after seeding; either before or after the crop has emerged.

Fall Applications

The main advantage of fall application is the length of time available to fertilize. This can relieve time pressures in the spring relating to fertilizer handling and application.

Banding of N fertilizer is the most common fall application practice because N prices are often lower in the fall than in the spring. It is most effective when soil temperatures have cooled to less than 10°C, because soil microbial processes involving N are minimized. The greatest risk faced when considering fall application of N is the potential for denitrification N losses in the spring when soils can be saturated after spring snowmelt.

Losses from fall banded P and K are very rare. Research suggests that the timing of P fertilizer banding (fall versus spring) appears to have little effect on fertilizer

efficiency. Broadcasting elemental sulphur fertilizer in the fall allows more time for weathering and conversion to crop available forms.

Soil sampling should always occur prior to nutrient application, however, soil analysis results may not be available to plan fall fertilizer applications. A common practice is to split fertilizer application between fall and spring. A base rate is applied in the fall, followed in the spring by an application based on moisture conditions and soil test recommendations from fall sampling. Fall fertilizer application also means an extra field operation. This can add to production costs, reduce snow-trapping capability, and increase a field's erosion potential.

Since snowmelt is responsible for the bulk of runoff in Alberta, unincorporated fall broadcast nutrients are at risk of being lost. Wet conditions in early spring that occur on fine textured and poorly drained soils in central and northern Alberta can cause significant losses of fall applied nitrogen through denitrification. Fall broadcast applications of N are most subject to loss. Table 5.1.3 shows the relative efficiency of fall and spring broadcast and banded applications under various conditions.

Table 5.1.3 Relative Effectiveness of Different Methods and Timing of Nitrogen Application (yield improvement compared to spring broadcast and incorporation = 100)

Application Method	Soil Climate Categories			
	Dry ¹	Medium ²	Wet ³	Irrigated ⁴
Spring Broadcast and Incorporation	100	100	100	100
Spring Banded	120	110	105	110
Fall Broadcast and Incorporation	90	75	65	95
Fall Banded	120	110	85	110

- ¹ Well drained soils that are seldom saturated during spring thaw. Although spring and fall banded nitrogen were equally effective in research trials, fall banding may be more practical under farm conditions. The extra tillage associated with spring banding may dry the seedbed and reduce yields.
- ² Well to moderately drained soils that are occasionally saturated during spring thaw for short periods.
- ³ Poorly to moderately drained soils that are saturated for extended periods during spring thaw. In research trials conducted in the higher rainfall areas, spring broadcast nitrogen was well incorporated and seeding and packing completed within a short period of time. Under farm conditions, shallow incorporation or loss of seedbed moisture resulting from deeper incorporation may cause spring broadcasting to be somewhat less effective than shown here.
- ⁴ Well drained soils in southern Alberta that are seldom saturated during spring thaw.

From Kryzanowski, L., 2004

tip



Late summer applications of fertilizer are recommended for forage seed production to maximize yield, as forages are setting their yield potential in the fall.



tip



Research in Alberta suggests that, based on moisture conditions, fertilizing winter cereals at seeding to meet requirements is an efficient way of fertilizing fall-sown crops.



Spring Applications

Spring application in this discussion refers to fertilization prior to or at seeding. The idea is to provide immediately available nutrients to the growing crop. There are several advantages of spring versus fall application including:

- During spring application nutrients are applied close to when the crop requires them.
- Nutrients are not stored over the winter in the soil so they are not susceptible to early spring losses (e.g., runoff, denitrification). An exception is elemental S fertilizer, which has less opportunity to convert to crop available forms when applied in the fall.
- Spring application allows for more precise nutrient applications, since spring moisture conditions can be considered.
- Soil analysis results and changes in expected crop prices can be incorporated into planning.
- By applying fertilizer in the spring, high disturbance field operations can be avoided in the fall, leaving more standing crop residue to trap snow and enhance moisture retention.
- Applying in the spring may allow the possibility of combining the seeding and fertilizer operations into one-pass, reducing field operations.

Some of the disadvantages of spring application include:

- The soil disturbance associated with spring application can dry out the seedbed thereby reducing germination and yield potential.
- The time required to complete seeding and related field operations may increase.
- Regional weather conditions in the spring can have a large impact on demand for fertilizer, which can impact availability and cost.

Some producers purchase fertilizer in the fall and store it until spring. This requires suitable storage facilities, which can be a substantial cost. Storing fertilizer also has an environmental risk, since inappropriate storage can result in nutrient release to the environment.

Post-Emergent Applications

Post-emergent fertilizer application refers to an application after crop emergence including: fertigation, broadcast, banded, and foliar applications. The major advantage of post emergent fertilizer application is that it permits adaptation to dramatic changes in growing conditions after seeding (e.g., moisture conditions or nutrient deficiencies). When moisture conditions are better than expected, additional fertilizer can help to take advantage of the increased yield potential. Alternatively, excessive precipitation can lead to conditions that promote nutrient loss and additional fertilizer could be applied to compensate for losses.

In some instances, post-emergent nutrient applications can result in crop damage. This is influenced by crop type and stage of development, as well as environmental conditions at the time of application. For each nutrient, there are limits on the form and amount that can be safely foliar-applied to the crop.

A major challenge with post emergent applications is that to be effective nutrients must be taken up by the plant before productivity is limited by deficiencies. There is a very narrow window of opportunity for this to happen successfully. In addition, multiple applications represent additional costs.

summary

- Fertilizer can be applied in several ways including broadcast (with or without incorporation), seed-placed, banded, foliar, or fertigation.
- Broadcast applications, especially without incorporation, carry the greatest risk of nutrient loss. Broadcast application is recommended when using fertilizers containing elemental sulphur to promote weathering.
- Seed-placed and side-band applications are generally the most effective because nutrients are placed in close proximity to the seed.
- Foliar applications are not effective for most nutrients (N, P, K, and S) because leaves cannot absorb enough nutrients for plant growth.
- Fertigation allows nutrients to be supplied throughout the growing season using irrigation systems. If inadequate water is applied, fertilizer nutrients can be lost through volatilization or stranded at the soil surface out of reach of plant roots.
- The main advantages of fall application are lower fertilizer prices and greater time availability. Excessively wet conditions in **early spring can cause significant losses of fall applied N through denitrification.**
- Some advantages of spring application include nutrients are applied close to when the crop requires them and are not susceptible to early spring losses. A disadvantage of spring application is the **extra time required for field operations.**
- Post emergent fertilizer application permits adaptation to dramatic changes in growing conditions after seeding.

Chapter 6.1

Calculating Manure Application Rates and Fertilizer Requirements

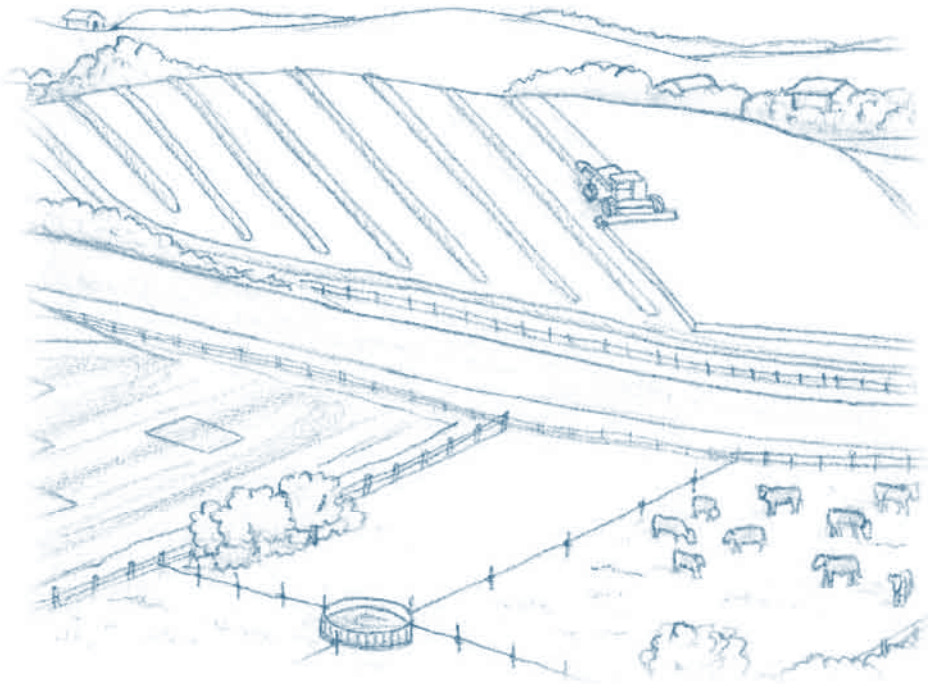

→ learning objectives

- Calculate manure application rates.
- Calculate amounts of residual nitrogen and phosphorus applied.
- Determine whether available land base is sufficient.
- Determine additional fertilizer requirements.



Important Terms

Table 6.1.1 Key Terms and Definitions

Term	Definition
N-Based Application	A manure application rate calculated to meet the nitrogen (N) requirements of the crop.
P-Based Application	A manure application rate calculated to meet the phosphorus (P) requirements of the crop.
Reference Nutrient	The 'nutrient' on which the manure application rate was based or developed (e.g., nitrogen, phosphorus).
Threshold Application Rate	A simple calculation to determine whether the eligible land base will be sufficient to accommodate the total annual manure collected.

One of the most critical tasks in manure nutrient management planning is determining the appropriate manure application rates to get the desired crop productivity. It is also necessary in certain scenarios to determine fertilizer application rates to meet any nutrient requirements not met through manure application. These activities involve using information discussed in earlier chapters, including:

- available land base
- soil nutrient profile
- crop nutrient requirements
- nutrient content of manure
- application method and conditions

This chapter will work through the procedure for calculating manure application rates and determining fertilizer requirements. A hypothetical case study will be used to illustrate and reinforce the principles in each step.

Calculating Manure Application Rates

Calculating manure application rates involves four steps:

1. Estimate available nutrient content of manure
2. Determine crop nutrient requirements

3. Determine basis for application rate calculation
4. Calculate manure application rate

If manure is sampled during loading or application use “book values” or historical information on bulk density and manure nutrient content to calculate manure application rates. Once bulk density and manure analysis information is available repeat the calculations using this information to determine the correct manure and nutrient application rates and determine whether additional fertilizer is required.

Once the application rate has been determined, estimate the amount of nutrients that will become available in that year plus subsequent years, from that application. If a whole farm nutrient management plan is being developed determine whether additional area is required to apply all of the manure at agronomic rates.

Large surpluses of manure may suggest a need to:

- Build cooperative relationships with surrounding landowners to secure additional land for manure application.
- Consider alternative treatment measures, such as solid-liquid separation technologies or composting to increase the distance manure can be transported economically.
- Develop marketing options for the manure produced.

Estimate Available Nutrient Content of Manure

Chapter 4.2 described techniques for manure sampling. Once the results of the manure analysis are available the amount of crop available nutrients in the manure can be calculated, as illustrated in Chapter 4.3. Crop available nutrient content is a main factor that will influence manure application rate calculations.

» Crop Available Nutrient Calculations

Several equations used to estimate crop available nutrient content of manure, originally presented in Chapter 4.3, are presented here for reference purposes. For a more detailed discussion of estimating crop available nutrient content refer to Chapter 4.3.

Crop Available N Calculations

$$\text{Organic N} = \text{Total N} - \text{NH}_4\text{-N}$$

$$\text{Available Organic N (year 1)} = \text{Organic N} \times 0.25$$

$$\text{Available Organic N (year 2)} = \text{Organic N} \times 0.12$$

$$\text{Available Organic N (year 3)} = \text{Organic N} \times 0.06$$

$$\text{Retained NH}_4\text{-N} = \text{NH}_4\text{-N} \times \text{Retention Factor}$$

(Table 4.3.4)

$$\text{Estimated Crop Available N} = \text{Available Organic N (year 1)} + \text{Retained NH}_4\text{-N}$$

Crop Available P Calculations:

$$\text{Estimated Crop-Available P (year 1)} = \text{Total P} \times 0.7$$

$$\text{Estimated Crop-Available P (year 2)} = \text{Total P} \times 0.2$$

$$\text{Estimated Crop-Available P (year 3)} = \text{Total P} \times 0.06$$

Crop-Available K Calculations:

$$\text{Estimated Crop-Available K} = \text{Total K} \times 0.9$$

Crop Availability of Other Nutrients in Manure

There is little need to be concerned about the crop availability of Ca, Mg and micronutrients (e.g., iron, zinc, copper) in manure. In Alberta soils deficient in nutrients other than N, P, K are rare, particularly if a field has received manure in recent memory.

Also due to the balance (or imbalance) of nutrients in manure, if application rate is based on either N or P, all other nutrients will likely be applied at rates several times higher than agronomic requirements.



Estimating Crop Available Nutrient Content

Lab analysis of liquid and solid manure sources yielded the following nutrient content information:

Source	Moisture	Total N (wet basis)	NH ₄ -N ¹ (wet basis)	Total P (wet basis)	Total K (wet basis)
Liquid	92 %	3.8 g/L	1.9 g/L	1.0 g/L	4.3 g/L
Solid	50 %	8.3 kg/t	2.0 kg/t	2.3 kg/t	6.9 kg/t

¹ NH₄-N is Ammonium-Nitrogen

Crop Available N

Liquid manure source:

$$\text{Organic N (g/L)} = 3.8 \text{ g/L} - 1.9 \text{ g/L}$$

$$\text{Organic N (g/L)} = 1.9 \text{ g/L}$$

$$\text{Available Organic N, year 1 (g/L)} = 1.9 \text{ g/L} \times 0.25$$

$$\text{Available Organic N, year 1 (g/L)} = 0.5 \text{ g/L}$$

Since the intention is to inject manure during wet/cool spring conditions:

$$\text{Retained NH}_4\text{-N (g/L)} = 1.9 \text{ g/L} \times 1.00$$

(from Table 4.3.4)

$$\text{Retained NH}_4\text{-N (g/L)} = 1.9 \text{ g/L}$$

$$\text{Crop Available N (g/L)} = 0.5 \text{ g/L} + 1.9 \text{ g/L}$$

$$\text{Crop Available N (g/L)} = 2.4 \text{ g/L}$$

Crop Available P

Liquid manure source:

$$\text{Crop Available P (year 1) (g/L)} = 1.0 \text{ g/L} \times 0.7$$

$$\text{Crop Available P (year 1) (g/L)} = 0.7 \text{ g/L}$$

Crop Available K

Liquid manure source:

$$\text{Crop Available K (g/L)} = 4.3 \text{ g/L} \times 0.9$$

$$\text{Crop Available K (g/L)} = 3.9 \text{ g/L}$$

Solid manure source:

$$\text{Organic N (g/kg)} = 8.3 \text{ kg/t} - 2.0 \text{ kg/t}$$

$$\text{Organic N (g/kg)} = 6.3 \text{ kg/t}$$

$$\text{Available Organic N, year 1 (kg/t)} = 6.3 \text{ kg/t} \times 0.25$$

$$\text{Available Organic N, year 1 (kg/t)} = 1.6 \text{ kg/t}$$

Since the intention is to surface apply during wet/cool spring conditions and incorporate within 2 days:

$$\text{Retained NH}_4\text{-N (g/kg)} = 2.0 \text{ kg/t} \times 0.87$$

(from Table 4.3.4)

$$\text{Retained NH}_4\text{-N (g/kg)} = 1.7 \text{ kg/t}$$

$$\text{Crop Available N (g/kg)} = 1.6 \text{ kg/t} + 1.7 \text{ kg/t}$$

$$\text{Crop Available N (g/kg)} = 3.3 \text{ kg/t}$$

Solid manure source:

$$\text{Crop Available P (year 1) (g/kg)} = 2.3 \text{ kg/t} \times 0.7$$

$$\text{Crop Available P (year 1) (g/kg)} = 1.6 \text{ kg/t}$$

Solid manure source:

$$\text{Crop Available K (kg/t)} = 6.9 \text{ kg/t} \times 0.9$$

$$\text{Crop Available K (kg/t)} = 6.2 \text{ kg/t}$$

Summary of crop available nutrient content for the solid and liquid manure sources in the year of application:

Source	Crop Available N	Crop Available P	Crop Available K
Liquid	2.4 g/L	0.7 g/L	3.9 g/L
Solid	3.3 kg/t	1.6 kg/t	6.2 kg/t

It may be necessary to convert units appearing on the lab report, depending on testing facility and the units used in subsequent calculations. Many of the common conversions were presented in Table 4.3.3 (Chapter 4.3).

Determine Crop Nutrient Requirements

Use fertilizer recommendations generated by a testing facility based on representative soil samples to determine crop nutrient requirements. Remember that lab recommendations for P and K are reported as kg or lb of P_2O_5 and K_2O , respectively, which is not useful when applying manure. Available P and K content of manure must be converted to available P_2O_5 and K_2O in order to calculate manure application rate using fertilizer recommendations.

To convert P to P_2O_5 , and K to K_2O , use the following equations:

$$P_2O_5 = P \times 2.29$$

$$K_2O = K \times 1.20$$

For situations where, for one reason or another, soil testing on an annual basis is either not possible or practical, an alternative strategy will need to be used. In order of preference, some alternatives are:

- Use fertilizer recommendations from comparable soil analysis results. This could include past recommendations for that field or recommendations for neighbouring fields under similar management.
- Use historical application rates, provided historical yield, quality (e.g., protein) and production factors (e.g., lodging, maturity) suggest that these rates were appropriate.
- Apply manure nutrients so as to replace nutrients removed by the crop at expected yields (Appendix 6). Information on historical yields can help estimate crop nutrient removal.

Note that none of these approaches are acceptable substitutes for soil testing in the long term but may be reasonable compromises if annual sampling of all fields is not possible. Remember that for a field to be eligible to receive manure AOPA requires soil analysis from within the last 3 years.

more info



A useful online calculator is available on **Ropin' the Web**, to estimate crop uptake and or removal for several crops at various yields. To access this calculator, visit **Ropin' the Web** and select the "Calculators" tab from the horizontal toolbar on the homepage. The calculator is called "Grains, Forage and Straw Nutrient Use".





Case Study: Determining Crop Nutrient Requirements

Based on the background information provided and results of the soil analysis the testing facility recommended the following fertilizer rates for a field:

Recommendations based on expected moisture conditions during growing season								
Dry (130 mm)			Average (200 mm)			Wet (270 mm)		
N	P ₂ O ₅	K ₂ O	N	P ₂ O ₅	K ₂ O	N	P ₂ O ₅	K ₂ O
22 kg/ha 20 lb/ac	22 kg/ha 20 lb/ac	-	44 kg/ha 40 lb/ac	28 kg/ha 25 lb/ac	-	78 kg/ha 70 lb/ac	39 kg/ha 35 lb/ac	-

Based on long-term weather patterns, expected crop prices and the fact that the manure has only a small cost associated with it (relative to fertilizer), manure application rate to be developed was based on the fertilizer recommendations for wet conditions.

Determine Basis for Application Rate

» N-Based Application

Current practice in Alberta is to base manure application on crop available N, which is the first limiting nutrient in most Alberta cropping scenarios. The impact this practice has on levels of other nutrients in the soil should be considered. By applying manure based on N, other nutrients including P and K will be simultaneously applied at rates that exceed crop removal. This is due to the typical nutrient content of most manure. This has three important implications:

- Applying nutrients above their agronomic requirement prevents the full economic value of manure to be realized.
- Research has clearly demonstrated that long-term application of P above agronomic rates is contributing to P build-up in surface soil layers to the point that the risk of runoff losses is increased. Loss of P to surface water is a significant environmental concern.

- High soil test levels of certain nutrients can impair the crop's ability to take up other essential nutrients (e.g., high soil test P can impair zinc uptake).

If manure is to be applied based on N, monitor soil test P levels regularly. Crops generally do not respond to soil test P levels above 112 kg/ha (100 lb/ac) in the top 15 cm of soil and higher levels increase the risk of runoff losses.

Due to equipment limitations it may be necessary to apply more than one-year's worth of manure, particularly if only small rates of manure application are suggested for a particular field.

» P-Based Application

One way of avoiding nutrient accumulation in soils is to apply manure based on P. At present, however, there is no one single prescribed strategy for applying manure on a P basis. One of the major constraints to P-based application is that current application technologies are not able to consistently apply manure at the low rates that would be required to meet agronomic P requirements for a

single crop year. Even if technology allowed, it has been estimated that doing so would likely increase the area required for manure application by anywhere from 3 to 6 times compared to N-based application.

A logical P-based application strategy, if land base allows, would involve applying manure so as to supply three to four years worth of P in a single application. One consideration for using this approach is that while only 70 % of total manure P will be available in the year of application, much of the remaining P will come available over the subsequent two years.

A P-based application strategy that supplies three to four years worth of P will require supplemental N fertilizer applications to support subsequent crops. Annual soil sampling is recommended to determine N fertilization requirements and to monitor levels of soil test P. If soil test P remains high after the third year subsequent manure applications should be delayed. Whenever applying multiple years worth of P take precautions to minimize the risk of P losses in runoff by adopting suitable land management practices (see Chapters 8.2 and 8.3).

If land base relative to manure production is restricted, arrangements will likely need to be made with neighbouring landowners to secure additional area.

Calculate Manure Application Rate

Calculate application rate by dividing the recommendation for the nutrient being used as the basis for application (i.e., reference nutrient, N or P) by its concentration in the manure.

The generic calculation of manure application rate is:

Application rate =
Reference nutrient recommendation ÷ Reference manure
nutrient concentration

Remember that if application is based on P, concentration of available P in the manure must be converted to a P_2O_5 basis in order to use the fertilizer recommendations from the soil analysis. In some instances, it may be also necessary to convert factors in the equation so that the units are consistent.



Case Study: Calculating Manure Application Rate

Recall that manure application will take place under wet, cool conditions, liquid manure will be injected and solid manure is surface applied and incorporated within two days. Application rates will be calculated for the following scenarios:

1. Single-year application based on manure available N
2. One-time application of two years worth of manure available N
3. One time, three-year application based on manure available P

To review:

- The liquid manure source contains:
2.4 g/L crop available N
0.7 g/L crop available P
3.9 g/L crop available K
- The solid manure source contains:
3.3 kg/t crop available N
1.6 kg/t crop available P
6.2 kg/t crop available K
- The fertilizer recommendations for the field, based on soil test results were 78 kg/ha of N and 39 kg/ha of P_2O_5





Scenario 1: N-based; Single-Year Application Rate

Liquid manure:

The target application rate to supply one year's worth of available N is:

$$\text{Application rate (metric units)} = 78 \text{ kg/ha} \div 2.4 \text{ kg/1,000 L} \times 1,000$$

$$\text{Application rate (metric units)} = 32,500 \text{ L/ha}$$

To convert this to imperial units:

$$\text{Application rate (imperial units)} = 32,500 \text{ L/ha} \times 0.089 \text{ (Table 4.3.3)}$$

$$\text{Application rate (imperial units)} = 2,893 \text{ gal/ac}$$

*Nutrient concentrations in g/L are the same as kg/1,000 L

Solid manure:

The target application rate to supply a single year's worth of available N is:

$$\text{Application rate (metric units)} = 78 \text{ kg/ha} \div 3.3 \text{ kg/t}$$

$$\text{Application rate (metric units)} = 23.6 \text{ t/ha}$$

To convert this to imperial units:

$$\text{Application rate (imperial units)} = 23.6 \text{ t/ha} \times 0.4461 \text{ (Table 4.3.3)}$$

$$\text{Application rate (imperial units)} = 10.5 \text{ tn/ac}$$



Scenario 2: N-based; One Time, Two-Year Application Rate

When applying multiple years' worth of N do not exceed AOPA $\text{NO}_3\text{-N}$ limits for the soil zone (Chapter 4.4). In calculating available manure N be sure to account for mineralization of organic N in the year following the application. Since approximately 12% of the organic N fraction will become available in the year following application, the crop available N estimate must be adjusted for additional N:

$$\text{Available Organic N (years 1 and 2)} = \text{Total Organic N} \times (0.25 + 0.12)$$

$$\text{Crop Available N} = \text{Available Organic N (years 1 and 2)} + \text{Retained } \text{NH}_4\text{-N}$$

Liquid manure

$$\begin{aligned} \text{Available Organic N, years 1 and 2 (g/L)} &= 1.9 \text{ g/L} \times (0.25 + 0.12) \\ &= 0.7 \text{ g/kg} \end{aligned}$$

$$\begin{aligned} \text{Crop Available N (g/L)} &= 0.7 \text{ g/L} + 1.9 \text{ g/L} \\ &= 2.6 \text{ g/L} \end{aligned}$$

The target application rate to supply 2 years worth of N would be:

$$\begin{aligned} \text{Application rate (metric units)} &= 2 \times 78 \text{ kg/ha} \div 2.6 \text{ kg/1000 L} \times 1000 \\ &= 60,000 \text{ L/ha} \end{aligned}$$

$$\begin{aligned} \text{Application rate (imperial units)} &= 60,000 \text{ L/ha} \times 0.089 \text{ (Table 4.3.3)} \\ &= 5,340 \text{ gal/ac} \end{aligned}$$

*Nutrient concentrations in g/L are equivalent to kg/1000 L

Solid manure

$$\text{Available Organic N, years 1 and 2 (g/kg)} = 6.3 \text{ kg/t} \times (0.25 + 0.12)$$

$$\text{Available Organic N, years 1 and 2 (g/kg)} = 2.3 \text{ kg/t}$$

$$\text{Crop Available N (g/kg)} = 2.3 \text{ g/kg} + 1.7 \text{ g/kg}$$

$$\text{Crop Available N (g/kg)} = 4.0 \text{ kg/t}$$

The target application rate to supply 2 years worth of N would be:

$$\begin{aligned} \text{Application rate (metric units)} &= 2 \times 78 \text{ kg/ha} \div 4.0 \text{ kg/t} \\ &= 39 \text{ t/ha} \end{aligned}$$

$$\begin{aligned} \text{Application rate (imperial units)} &= 39 \text{ t/ha} \times 0.4461 \text{ (Table 4.3.3)} \\ &= 17.4 \text{ tn/ac} \end{aligned}$$





Scenario 3: P-based; One Time, Three-Year Application Rate

Since residual manure P will be mineralized in the years following application, the same procedure as in the previous scenario is followed to correct the estimated crop available P content:

$$\text{Crop Available P (years 1, 2 and 3)} = \text{Total P} \times (0.7 + 0.2 + 0.06)$$

$$\text{Crop Available P}_2\text{O}_5 \text{ (years 1, 2 and 3)} = \text{Crop Available P} \times 2.29$$

Liquid manure:

$$\begin{aligned} \text{Crop Available P; years 1, 2 and 3 (g/L)} &= 1.0 \text{ g/L} \times (0.7 + 0.2 + 0.06) \\ &= 0.96 \text{ g/L} \end{aligned}$$

$$\begin{aligned} \text{Crop Available P}_2\text{O}_5, \text{ years 1, 2 and 3 (g/L)} &= 0.96 \text{ g/L Available P} \times 2.29 \\ &= 2.20 \text{ g/L} \end{aligned}$$

The target application rate to supply 3 years worth of P would be:

$$\begin{aligned} \text{Application rate (metric units)} &= 3 \times 40 \text{ kg/ha} \div 2.20 \text{ kg/1,000 L} \times 1,000 \\ &= 54,545 \text{ L/ha} \end{aligned}$$

$$\begin{aligned} \text{Application rate (imperial units)} &= 54,545 \text{ L/ha} \times 0.089 \text{ (Table 4.3.3)} \\ &= 4,854 \text{ gal/ac} \end{aligned}$$

*Nutrient concentrations in g/L are equivalent to kg/1000 L

Solid manure:

$$\begin{aligned} \text{Adjusted Crop Available P (kg/t)} &= 2.3 \text{ g/kg} \times (0.7 + 0.2 + 0.06) \\ &= 2.21 \text{ kg/t} \end{aligned}$$

$$\begin{aligned} \text{Crop Available P}_2\text{O}_5, \text{ years 1,2 and 3 (kg/t)} &= 2.21 \text{ kg/t Available P} \times 2.29 \\ &= 5.06 \text{ kg/t} \end{aligned}$$

The target application rate to supply 3 years worth of P would be:

$$\begin{aligned} \text{Application rate (metric units)} &= 3 \times 40 \text{ kg/ha} \div 5.06 \text{ kg/t} \\ &= 23.7 \text{ t/ha} \end{aligned}$$

$$\begin{aligned} \text{Application rate (imperial units)} &= 23.7 \text{ t/ha} \times 0.4461 \text{ (Table 4.3.3)} \\ &= 10.6 \text{ tn/ac} \end{aligned}$$

Calculating Amounts of Residual N and P Applied

There can be substantial excess application of certain nutrients depending on whether application rate is P-based or N-based. After calculating a target application rate, calculate the rates at which other nutrients will be applied.

Portions of residual organic N and P applied will become available in subsequent years. These will not be reflected in subsequent soil tests, but will impact fertilizer requirements.



Determining Application Rates of Other Manure Nutrients

Using the calculated application rates for solid and liquid manure from scenario 1 of the previous example, where manure application was based on a one-year supply of available N:

Solid application rate = 23.6 t/ha

Liquid Application rate = 32,500 L/ha

Available N applied in both situations = 78 kg/ha

The resulting application rates for total and available P and P₂O₅ are:

Liquid manure

Total P applied (kg/ha) = 32,500 L/ha ÷ 1,000 × 1.0 kg/1,000 L

Total P applied (kg/ha) = 32.6 kg/ha

Total P₂O₅ applied (kg/ha) = 32.6 kg/ha × 2.29

Total P₂O₅ applied (kg/ha) = 74.7 kg/ha

By using the factors presented earlier (Estimated crop available P in: year 1 = Total P × 0.7, year 2 = Total P × 0.2, and year 3 = Total P × 0.16), this translates to the following nutrient applied by the liquid manure application:

	Year 1	Year 2	Year 3
	kg/ha	kg/ha	kg/ha
Retained NH ₄ -N applied	61.8	N/A	N/A
Available organic N	16.3	7.4	3.7
Total crop available N	78	7.4	3.7
Available P	22.8	6.5	2.0
Available P ₂ O ₅	52.2	14.9	4.6

Solid manure

Total P applied (kg/ha) = 23.6 t/ha × 2.3 kg/t

Total P applied (kg/ha) = 54.3 kg/ha

Total P₂O₅ applied (kg/ha) = 54.3 kg/ha × 2.29

Total P₂O₅ applied (kg/ha) = 124.3 kg/ha

By using the factors presented earlier (Estimated crop available P in: year 1 = Total P × 0.7, year 2 = Total P × 0.2, and year 3 = Total P × 0.16), this translates to the following nutrient applied by the solid manure application:

	Year 1	Year 2	Year 3
	kg/ha	kg/ha	kg/ha
Retained NH ₄ -N applied	40.1	n/a	n/a
Available organic N	37.2	17.8	8.9
Total crop available N	78	17.8	8.9
Available P	38.0	10.9	3.3
Available P ₂ O ₅	87.0	24.9	7.5

side bar

The rate at which other nutrients were applied can also be calculated, provided the concentrations of these in the manure were analyzed and reported, the application rate and availability estimates (if applicable) are known.





For the solid manure source in the above example, total P would be applied in excess of crop requirements. This means that if this manure was applied annually, based on a single year's requirement of available N, P would begin to accumulate in the soil.

This example illustrates the value of doing these calculations as well as the value of soil and manure testing. Depending on the natural risks (e.g., presence of neighbouring water bodies, high soil test phosphorus) associated with this field it might be advisable to consider basing application on P recommendations. Remember that if you choose a P-based application strategy soil N and P status needs to be monitored to ensure adequate nutrients for subsequent crops.



Manure Supply versus Available Land Base

If a farm-scale, multiple field nutrient management plan is being developed it is important to determine whether the supply of manure will exceed the available land base eligible to receive manure.

Calculating the land base required to apply stockpiled manure requires three pieces of information:

- manure application rate
- area eligible to receive manure
- total volume or weight of manure to be applied

The method for calculating manure application rates was described earlier in this chapter. The area eligible to receive manure is determined during the site assessment, taking into account physical limitations and legislated application setbacks.

Refer to Chapters 3.1 and 3.2 for more information on site assessment and determining the area of a field eligible to receive manure. Legislated constraints to manure

application under the *Agricultural Operation Practices Act* (AOPA), which also impacts area available for application can be found in Chapter 4.4.

Use either standard estimates for manure production or estimate volume directly using the procedures and calculations outlined in Chapter 4.1 (preferred method). Solid manure is expressed in terms of weight, which requires that density of the material be considered. In the absence of a measured density average values for common livestock manures are presented in Table 6.1.2.

Table 6.1.2 Estimated Density of Selected Solid Manure Sources

Species/Class	Manure Density	
	kg/m ³	lb/ft ³
Beef, cows/finishers	655	40.9
Beef, feeders	641	40.0
Swine, farrow-to-finish	796	49.7
Swine, grow/finish	772	48.2
Poultry, broilers/pullets	320	20.0
Poultry, turkey toms	248	15.5
Sheep, ewes/rams	497	31.0
Goats, general	497	31.0
Horses, feeders	529	33.0

Derived from values presented in AOPA: *Manure Characteristics and Land Base Code* (2006).

In the event that manure supply exceeds eligible land base, additional land will need to be found in order to apply manure sustainably. This may require arrangements or formal agreements to be made with neighbouring landowners.

If eligible land base exceeds manure supply the issue then becomes how to prioritize fields for application to maximize economic benefit. Fields can be prioritized based on:

- distance to field from storage
- fertility requirements (e.g., high nutrient use crops, high fertilizer recommendations)
- value of the crop to be grown
- the presence of degraded soils (e.g., eroded areas, low organic matter, poor tilth) that would benefit from manure application
- the desire to minimize nuisance to neighbours or environmental risk
- accessibility or flexibility in crop management

Distance from the storage site to the application site is probably the biggest single factor influencing the economics of manure usage. In most situations, fields closest to the manure source are manured the most. For operations with a history of manure application, however, applying manure to fields further away may help to reduce nutrient build-up in fields closer to the manure source. In addition, this may help to extract greater economic benefit from manure nutrients since they will be used to support crop growth rather than contributing to nutrient surpluses in soil.

Crops with higher economic value (e.g., canola) may yield greater economic returns from the nutrients applied than lower value crops (e.g., oats). Degraded or poor quality soils can often benefit the most from manure application. This is due to soil building properties of manure as well as nutrient content, which help to improve the general productivity of these areas.

Fields may also be prioritized so as to minimize odour complaints from neighbours. Selecting fields with minimal natural environmental risk (e.g., slope or proximity to water bodies or other sensitive areas) is another strategy for prioritizing fields for application. Different cropping scenarios (e.g., silage production, fall cereals, forages) may offer potential for flexibility in manure allocation strategy. Fields that are drier earlier in the season may be given priority so manure application can begin earlier in the spring, reducing compaction issues and taking advantage of released nutrients.

» **Determining Whether Land Base is Sufficient**

A simple calculation can help a producer determine whether the eligible land base will be sufficient to accommodate annual manure production:

Threshold Application Rate =

Annual Manure Production ÷ Eligible Application Area

Based on the application strategy selected, if manure is applied at rates higher than this threshold, the eligible area will be sufficient. If manure is to be applied at a rate lower than this threshold, additional area will be required.

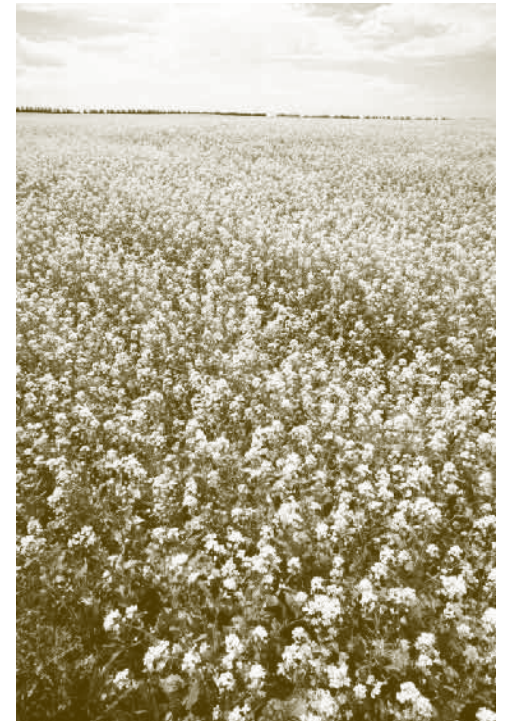



Determining Whether Available Land Base is Sufficient

From the earlier case study, the liquid manure source contained 3,200,000 L, while the solid manure source contained 984 t. The total area available for annual liquid manure application is 130 ha and the total area available to receive solid manure on an annual basis is 106 ha. The threshold annual application rates for these two manure sources and land bases are:

$$\begin{aligned} \text{Threshold application rate for liquid manure (L/ha)} &= 3,200,000 \div 130 \text{ ha} \\ &= 24,600 \text{ L/ha/yr} \end{aligned}$$

$$\begin{aligned} \text{Threshold application rate for solid manure (t/ha)} &= 984 \text{ t} \div 106 \text{ ha} \\ &= 9.28 \text{ t/ha/yr} \end{aligned}$$

Compare these threshold application rates to the application rates calculated in the case study:

Manure Source	Application Scenario 1 (N-based, single year application)	Application Scenario 2 (N-based, two year application)	Application Scenario 3 (P-based, three-year application)
Liquid	32,500 L/ha/yr	60,000 L/ha/2 yrs (= 30,000 L/ha/yr)	54,545 L/ha/3 yrs (= 18,181 L/ha/yr)
Solid	23.6 t/ha/yr	39 t/ha/2 yrs (= 19.5 t/ha/yr)	23.7 t/ha/3 yrs (= 7.9 t/ha/yr)

The total area of 130 ha, for the annual liquid manure application, has a threshold application rate of 24,600 L/ha/year. Therefore, there is sufficient land base available for the one-year and two-year N based application rates scenarios. Unfortunately, there is insufficient land base available for the liquid manure applied on a three-year P based application scenario. An additional 46 ha would be required to accommodate all the manure produced (3,200,000 L/year) if it was applied at the equivalent of 18,181 L/ha/year or 54,545 L/ha once every three years.

The total area of 106 ha, for the annual solid manure application, has a threshold application rate of 9.28 t/ha/year. Therefore, there is sufficient land base available for the one-year and two-year N based application rates scenarios. Unfortunately, there is insufficient land base available for the solid manure applied on a three-year P based application scenario. An additional 19 ha would be required to accommodate all the manure produced (984 t/year) if it was applied at the equivalent of 7.9 t/ha/yr or 23.7 t/ha once every three years.

» Estimating Additional Land Base Required

If it has been determined that the existing application area controlled by the operations is insufficient to accommodate annual manure production, the additional area can be estimated:

Additional Area Required = (Annual Manure Production ÷ Calculated Application Rate) - Current Eligible Area



Estimating Additional Land Base Required

The liquid manure source in the previous example had a total volume of 3,200,000 L and the intention is to apply this manure to meet the available P needs, three year application. The calculated application rate for this scenario is 18,181 L/ha, but the operation currently only has access to 130 ha. The additional land base required is:

$$\begin{aligned} \text{Additional Area Required (ha)} \\ &= 3,200,000 \text{ L/yr} \div 18,181 \text{ L/ha} - 130 \text{ ha} \\ &= 176 \text{ ha/yr} - 130 \text{ ha} \\ &= 46 \text{ ha/yr} \end{aligned}$$

The two examples above touch on some important calculations that CFO operators should consider. To apply manure at agronomic or sustainable rates many CFO's may require additional land to accommodate annual manure production. This issue is likely to become of greater concern to producers if legislation is introduced in the future that requires manure application to be based on phosphorus.

Estimating Remaining Fertilizer Requirements

Once manure nutrient application rates have been calculated (or verified after the fact) identify remaining nutrient deficits by subtracting nutrients applied (in manure) from fertility recommendations on the soil report. Fertilizer suppliers can typically develop a fertilizer blend customized to meet specific needs.

tip



Remember to account for nutrients that mineralize from manure with time when calculating fertilizer application rates for subsequent crops.



summary

- When calculating manure application rates consider the available nutrient content of manure, soil test results, crop nutrient recommendations and the application strategy (application method and basis for rate calculations).
- Once the basis for calculating application rates has been determined the application rates for N and P can be calculated by multiplying their estimated content in the manure by the application rate. If applying multiple years worth of manure, be sure to factor in mineralization of manure nutrients.
- There can be substantial excess application of certain nutrients depending on whether application rate is P-based or N-based. After calculating a target application rate, calculate the rates at which other nutrients will be applied. Portions of residual organic N and P applied will become available in subsequent years.
- Dividing the annual volume or weight of manure to be applied by the available land base will give the threshold application rate for an operation. By comparing this to the calculated application rate it is possible to determine whether the available land **base will be sufficient.**
- Estimating fertilizer requirements is easier because fertilizer recommendations are expressed on the same basis as fertilizer nutrient content, fertilizer nutrients are in crop-available forms and fertilizers can be custom blended to achieve a particular nutrient ratio.

Chapter 7.1

Record Keeping Requirements and the *Agricultural Operation Practices Act (AOPA)*

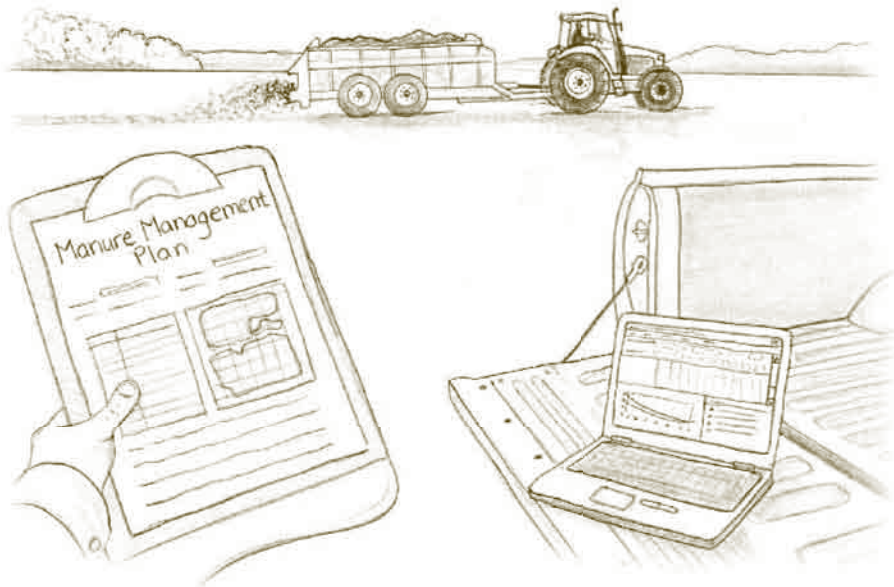

➔ learning objectives

- Identify who is required to keep manure management and handling records and how long they must be maintained under AOPA.
- Describe the records that must be kept by confined feeding operations, manure applicators, and for manure transfers.
- Identify required soil analysis information and minimum soil testing frequency under AOPA.

sidebar

AOPA record keeping requirements do not apply to grazing livestock. All livestock operations, however, are subject to the standards for manure collection, application and storage setback distances from neighbours and common bodies of water.



Important Terms

Table 7.1.1 Key Terms and Definitions

Term	Definition
Confined Feeding Operation (CFO)	Under AOPA, a CFO is defined as “fenced or enclosed land or buildings where livestock are confined for the purpose of growing, sustaining, finishing, or breeding by means other than grazing and any other building or structure directly related to that purposes but does not include residences, livestock seasonal feeding and bedding sites, equestrian stables, auctions markets, race tracks or exhibition grounds” (Standards and Administration Regulation under AOPA).

In Alberta, specific manure management records must be kept in order to comply with the Standards and Administration Regulation under AOPA.

Who Must Keep Records?

AOPA record-keeping requirements apply only to CFOs and individuals who transfer, receive, or apply more than 500 tonnes (t) (or approximately 500,000 L) of manure per year. Operations or individuals must maintain these records for a minimum of five years.

A common question asked by producers is: how many animals or animal units produce 500 t. Table 7.1.2 provides the estimated number of animals (or birds) it would take to produce 500 t of manure if they were in a confined area on an as removed from the pen basis.



Determining Whether an Operation Exceeds the 500 t Threshold

An operation winters 325 cows and 25 bulls for approximately 175 days per year, with calving season beginning towards the end of the confinement period in late March or early April.

Total Amount of Manure Produced = Number of animal x Amount of Manure Produced per animal per day
x Number of days the animals are confined

Manure produced by cows = 325 cows x 5.9 kg manure per day x 175 days
= 335,562.5 kg

Manure produced by bulls = 25 bulls x 5.9 kg manure produced/day x 175 days
= 25,812.5 kg

Total annual manure production = 335,562.5 kg + 25,812.5 kg
= 361,375 kg
= 361 t

Based on this estimate, this operation collects and handles only 361 t of manure per year and is therefore exempt from the record keeping and soil testing requirements under AOPA.

Table 7.1.2 Daily Manure Production and Estimated Population for Different Livestock to Produce 500 t Manure

Species/Class	Daily Manure Production ¹ (kg/day)	Assumed Length of Confinement (months)	Estimated Number of Animals to Produce 500 t of Manure
Beef			
Cows/Finishers	5.9	5	565
		8	354
Feeders (< 410 kg or <900 lb)	3.8	12	366
Feeder Calves (<250 kg or < 550 lb.)	1.5	12	926
Dairy			
Cows, Tie-stall Housing	63.5	12	22
Cows, Loose Housed	66.5	12	21
Cows, Dry	31.8	12	43
Replacement Heifers (breeding to calving)	27.5	12	49
Replacement Heifers (160 kg or 350 lb to breeding)	19.5	12	71
Calves (<160 kg or < 350 lb)	1.3	12	1,068
Swine			
Farrow-to-finish (per sow basis)	39.3	12	35
Farrow-to-wean (per sow basis)	12.1	12	115
Sows			
Weaner Pig	1.3	12	1,068
Grower Pig	2.2	12	623
Finisher Pig	3.7	12	375
Poultry (per 100 birds)			
Layers, Belt Cage	4.5	12	30,864
Layers, Deep Pit	5.9	12	23,540
Broilers	2.7	12	51,440
Breeders	7.2	12	19,290
Pullets	2.7	12	51,440
Turkey Hens	6.2	12	22,401
Turkey (Toms/Breeders)	9.0	12	15,432
Turkey Broilers	5.0	12	27,778

¹ Operations with more than one class or species of livestock will need to calculate total volume produced by factoring in daily manure production for each.





What Records Must Be Kept

The record keeping requirements are slightly different for CFOs and persons who transfer, receive, or apply more than 500 t of manure per year

Records for CFOs

CFOs must keep the following records on manure production and transfers (Figure 7.1.1):

- The volume or weight (estimated) of manure produced.
- The name and mailing address (or legal land description) of any person to whom control of 500 t (or more) of manure is transferred in a given year.
- The date(s) that manure is transferred.
- The volume or weight of manure transferred.

Operations that apply manure to land they control must also record information relating to application (discussed in the next two sections) in addition to that listed above.

CFO Manure or Compost Production Record (in compliance with Standards and Administration Regulation, Section 28 (2))			Name of operation: ABC Feeders
Operating Unit: Feedlot	Address: Box 99 Anywhere, AB	Legal Land Description: SE 6-18-22-W6	Year: 2006
Type of Livestock: Beef Finishers	Number of Livestock: 7,000	Manure Production Per Animal (t/year)*: 2.2 t/year	Total Volume/Weight (t or L): 15,400 tonnes
Est. Total N* (kg/t): 10 kg/t	Est. Crop N* (kg/t): 3.2 kg/t	*Values for these parameters are available in table form in the AOPA Manure Characteristics and Land Base Code available from AF.	
Record of Manure or Compost Transfers			
Date	Name	Address	Manure Volume/Weight (t or L)
April 18-21, 2006	Self	SW 6-18-22-W6	4,000 t
Sept. 21-26, 2006	J. Smith	NW 18-18-22-W6	5,080 t

Note: Table information in bold lettering is required by AOPA. Information in normal lettering is not required but is included to add clarity, especially for operations with more than one type of livestock.

Figure 7.1.1 Sample Record Keeping Form for CFOs

Records for Manure Transfers by Manure Applicators or Haulers

Persons involved in the transfer (i.e., persons who transfer control, haul or receive) of at least 500 t of manure per year must keep the following records (Figure 7.1.2):

- The name(s) and address(es) of the person(s) involved in the transfer (i.e., individual(s) who transferred control, hauled and received the manure).
- The date(s) during which the transfer occurred.
- The volume or weight of manure transferred, received or removed.

These record keeping requirements apply to custom manure applicators, producers who spread manure on their own land and anyone who receives 500 t (or more) of manure per year.



Manure Transfer #1: Transfer to J. Smith (Sept 2005)			
Manure or Compost Transfer Record Form (in compliance with Standards and Administration Regulation, Section 28(3), (4))			
Date:		Type (manure or compost):	
Sept 21-26, 2005		Solid manure	
	Transferred From	Removed by	Received by
Name	ABC Feeders	XY Corral Cleaners	J. Smith
Address	Box 99, Anywhere, AB	Box 33, Where, AB	Box 52, Here, AB
Volume/Weight (t or L)	5,080 t	5,080 t	5,080 t

Note: All information on this form is required. Each transfer requires a separate record.

Figure 7.1.2 Sample Record Form for Manure Applicators or Haulers Involved in Transfers of Manure



Records for Manure Application

Individuals applying 500 t (or more) of manure in a year to land under their control (owned or rented) must keep the following records (Figure 7.1.3):

- The name(s) and address(es) of the person(s) from whom manure is received (if applicable).
- The date(s) the manure was received (if applicable).
- The total volume or weight of manure that has been received.
- The legal land description of the land to which manure is applied.
- The area of the land to which manure is applied.
- The date(s) the manure is applied.
- The total volume or weight of manure applied.
- The application rates of manure nutrients and fertilizer by field and year.
- The date(s) of application and incorporation and the method(s) used for each field.
- Soil analysis results (see Soil Analysis Records in the next section).



Land Application Record (in compliance with Standards and Administration Regulation, Section 28(5))					
Owner	Legal Land Description	Field Name	Area	Soil Texture	
				0-15 cm	15-30 cm
ABC Feeders	SW 7-18-21-W6	All	64 ha	CL	CL
Soil Group (Dryland or Irrigated):				Dark Brown (Irrigated)	
Soil Test Records			Field Diagram: (or attach aerial photo)		
Date	Nitrate – N (0-60 cm)	Electrical Conductivity (0–15 cm) dS/m			
10/22/02	55 kg/ha	1.1			
10/14/05	35 kg/ha	1.1			
Record of Manure/Compost Sources					
Date received	Source of Manure		Volume or Weight (t or L)	Type of manure or compost	Estimated available N (kg/t or kg/1000 L)
	Name	Address			
Apr 18-21, 2006	Self	Box 99, Anytown, AB	4,000 t	Beef finisher	3.2kg/t
Sep 14, 2006	Compost Company	Box 32, Elsewhere, AB	2,900 t	Compost	0.5 kg/t
Nutrient Application Record					
Nutrient Application Record		Incorporation Record		Manure Application Rate (t/ha or L/ha)	Available N Application Rate (kg/ha)
Date	Volume or Weight Applied (t or L)	Date	Method Used		
May 5, 2005	Fertilizer	N/A	N/A	N/A	50 kg/ha
Apr 18-21, 2006	4,000 t	Apr 19-23, 2006	Cultivated	62.5 t/ha	200 kg/ha
Sep 14, 2006	2,900 t	Sept 16, 2006	Cultivated	40 t/ha	20 kg/ha

Note: Table information in bold lettering is required by AOPA. Information in normal lettering is not required, but is included to add clarity.

Figure 7.1.3 Sample Record Keeping Form for Land Applicators

more info



For more information on the record keeping requirements and record keeping forms can be found in the following resources (search by **Agdex number on the AF site**):

AF. www.agric.gov.ab.ca

NRCB. www.nrcb.gov.ab.ca

- AF. 2007. [AOPA: 2004 Reference Guide](#), **Agdex# 096-1.**
- AF. 2007. **Manure Management Record Keeping: What is required by AOPA, Agdex 096-3.**



Soil Analysis Records

If 500 t (or more) of manure is applied in a year, each field where manure is spread must be soil tested. Under AOPA, soil analysis information for each field receiving manure must be no older than three years, except for soil texture, which is a one-time analysis. These analyses must include:

- Extractable nitrate-nitrogen from a soil depth of 0 to 60 cm (0 to 24 in).
- Soil salinity based on electrical conductivity (EC) from a soil depth of 0 to 15 cm (0 to 6 in).
- Soil texture (one-time analysis) for depths of 0 to 15 cm (0 to 6 in) and 15 to 30 cm (6 to 12 in).

AOPA Record Keeping Forms

Blank forms that can be used to record the necessary information to comply with AOPA record-keeping standards are available from the AF Publications Office (toll free 1-800-292-5697) or can be downloaded from Ropin the Web by entering “AOPA Record Keeping” in the search window.

summary

- The record-keeping requirements in AOPA apply to CFOs and persons who transfer, receive or apply more than 500 t of manure per year.
- Records must be maintained for a **minimum of five years**.
- CFOs must record the estimated volume or weight of manure produced as well as information relating to transfers of manure. In addition, CFOs must record information pertaining to applications on land under their control.
- Individuals involved in the transfers of at least 500 t of manure per year must record contact information for all persons involved, transfer date(s) and volume(s) transferred.
- Individuals applying 500 t or more of manure in a year must record the following: contact information, dates (transfer, application, and incorporation), volumes (received and applied), a description of the application area (location and area), method of incorporation, manure (and fertilizer, if any) application rates, and soil analysis results.
- Soil analysis results (no older than three **years**) **are required for each field that receives manure and must include nitrate-nitrogen (0 to 60 cm), EC (0 to 15 cm) and a one-time determination of soil texture (0 to 15 cm and 15 to 30 cm).**

Chapter 7.2

AFFIRM and Alberta MMP Software

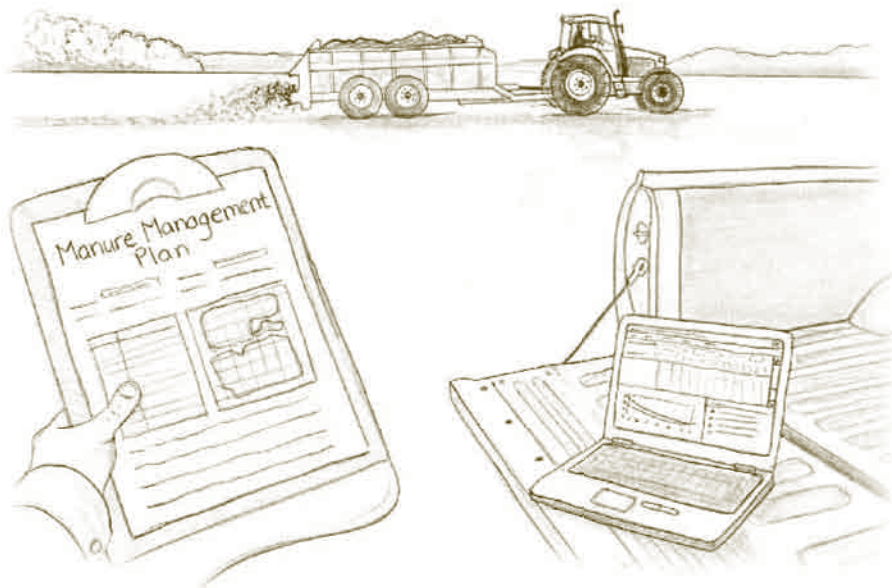

➔ learning objectives

- Identify information required to use the Alberta Farm Fertilizer Information and Recommendation Manager (AFFIRM).
- Identify information required to use the Alberta Manure Management Planner (MMP).
- Describe the output each software program can generate.



Important Terms

Table 7.2.1 Key Terms and Definitions

Term	Definition
Estimated Nitrogen Released (ENR)	An estimate of the total amount of crop available nitrogen that is released in the soil from the organic N pool over the growing season. It is related to soils organic matter content, moisture and temperature.
Farm Optimization	Systematic allocation of N fertilizer in 4.5 kg (10 lb) increments to those fields that will provide the highest economic return (i.e. the highest investment ratio) (IR) until all target investment ratios are achieved or the budget is exhausted.
Investment Ratio (IR)	The ratio of marginal return to marginal cost based on crop revenue and fertilizer costs. An investment ratio of 2:1 means that there is a two-dollar return for every one dollar invested.

There are two nutrient management planning and decision-making software tools available to Alberta producers free of charge. This chapter presents the basic information required for using AFFIRM and MMP software applications. This chapter is intended to be a general introduction to the software and is not intended to be a user guide. Please refer to the detailed user guides for full explanations and complete instructions for using these programs.

AFFIRM

The AFFIRM decision support software was developed by AF specialists to calculate crop nutrient requirements based on Alberta research and production economics. AFFIRM uses farm-specific information to generate fertilizer recommendations and to compare various cropping and economic scenarios. The software is used by extension specialists, farm consultants, agricultural retailers, producers, and students to select optimum fertilizer rates.

Records and Required Inputs for AFFIRM

The AFFIRM program has a series of windows to input farm-specific information. To generate fertilizer recommendations AFFIRM requires the following information:

- Producer and operation information
- Field location and soil group
- Soil information (including soil, previous crop and crop to be grown information)
- Fertilizer nutrient costs
- Expected crop price
- Farm fertilizer budget for farm optimization

Producer and Operation Information

In this window provide the name, address contact information for the operation and or producer (Figure 7.2.1).

Customer Information

Customer/Farm ID:

Farm name:

Last name:

First name:

Address:

City/Town:

Province:

Postal code:

Residential phone:

Business phone:

Fax:

eMail:

Read only

Sort by

Customer ID Farm name Last name First name Address City/Town

Ascending Descending

Figure 7.2.1 AFFIRM Producer and Operation Information

Field Location and Soil Group

Field location information is necessary to develop farm specific recommendations (Figure 7.2.2). AFFIRM can determine the soil group from the legal land description for the field (e.g., section-township-range-meridian). AFFIRM also allows the user to manually select the soil group from the 'Soil Map of Alberta'.

Field Information

Field ID#:

Field description:

Quarter section:

Section:

Township:

Range:

Meridian (W of):

Field size:

Soil group:

Ecoregion:

Ecodistrict:

Sort by

Field ID# Field description Soil group Ecoregion Ecodistrict Range Township

Ascending Descending

Figure 7.2.2 AFFIRM Field Location and Soil Group Information

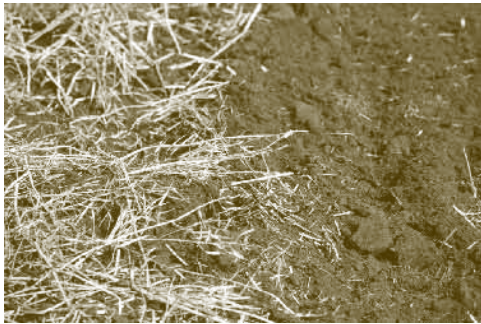

Soil Information

AFFIRM requires several pieces of information about each field (Figure 7.2.3):

- Previous crop, yield, tillage and residue management
- Soil analysis information including time of sampling time and depth(s), nitrate-nitrogen (NO₃-N), phosphorus (P), potassium (K), sulphate-sulphur (SO₄-S), soil pH and soil electrical conductivity (EC)
- Additional soil test information including micronutrients zinc (Zn), copper (Cu), manganese (Mn), iron (Fe), boron (B) and chloride (Cl), and CEC is optional
- Soil texture

Previous Crop: Canola **Soil Information** Current Crop: Feed barley

Sample depth: 0-6", 6-12", 12-24" ▼
 Soil sampling time: Spring ▼

Soil Test Results:
 Soil test laboratory: Norwest ▼

Depth	NO3-N	P	K	SO4-S	soil pH	soil EC	Soil texture	Zn	Cu	Mn	Fe	B	Cl	CEC
0-6"	22	10	100	15	6.5	0.1	Medium ▼	2.1	0.3	4.2	3.1	1.1		
6-12"	8			10	6.8	0.2	Medium ▼							
12-24"	2			13	7.1	0.3	Medium ▼							

Macro nutrient units: ppm or ug/g ▼
 Micro nutrient units: ppm or ug/g ▼

Figure 7.2.3 AFFIRM Soil Information

AFFIRM will calculate estimated nitrogen released (ENR) from soil organic matter (Figure 7.2.4). At a minimum, the software will use an average organic matter level for the appropriate soil zone. Actual soil analysis results for organic matter can be entered manually and will be used by AFFIRM to calculate ENR. AFFIRM also allows the user to enter a lab-calculated ENR.

Organic Matter (OM) and Estimated Nitrogen Release (ENR)

Soil test OM: Soil group OM:

PNR test: Lab analysis:

Lab calculated ENR:

AFFIRM calculated ENR:

Alert messages for ENR calculations:

- The ENR calculation is an estimate of the nitrogen release (mineralized) from soil organic matter and available for crop growth. It is dependent upon soil moisture and temperature during the growing season, residue management and landscape position.

Figure 7.2.4 AFFIRM ENR Calculator

tip



To get the latest version of AFFIRM, go to Ropin' the Web (search keyword: AFFIRM). A tutorial guide is also available for users at this site.





Fertilizer Nutrient Costs

AFFIRM fertilizer recommendations are based on expected yield responses of crops from research results and an economic analysis of marginal fertilizer cost to marginal yield returns. To make this economic analysis AFFIRM requires estimates of crop nutrient costs in \$ per lb (Figure 7.2.5). A calculator is built into AFFIRM to calculate individual crop nutrient costs based on the cost per tonne of individual fertilizers.

Fertilizer Nutrient Calculator ✕

	Fertilizer Type	Fertilizer Cost:		Actual Nutrient Cost	
Nitrogen Fertilizer	Urea (46-0-0) Granular	550	\$/tonne	0.54	\$/lb
Phosphate Fertilizer	Monoammonium Phosphate (11-52-0) Granular	450	\$/tonne	0.28	\$/lb
Potassium Fertilizer	Muriate of Potash (0-0-60) Granular	300	\$/tonne	0.23	\$/lb
Sulfur Fertilizer	Ammonium Sulfate (20-0-0-24S) Granular	350	\$/tonne	0.21	\$/lb
Boron Fertilizer			\$/tonne	0.00	\$/lb
Chlorine Fertilizer			\$/tonne	0.00	\$/lb
Copper Fertilizer			\$/tonne	0.00	\$/lb
Iron Fertilizer			\$/tonne	0.00	\$/lb
Manganese Fertilizer			\$/tonne	0.00	\$/lb
Zinc Fertilizer			\$/tonne	0.00	\$/lb

✔ Save
✕ Cancel
🗑️ Clear

Figure 7.2.5 AFFIRM Fertilizer Nutrient Cost Calculator

Expected Crop Price

Expected crop prices (dollars per tonne, bushel, ton or pound) are essential for AFFIRM's economics-based fertility recommendations (Figure 7.2.6).

Year	Crop Name	Sale Price	Yield Unit
2007	CWRS wheat	160.00	tonne
2007	Feed barley	150.00	tonne
2007	Canola	390.00	tonne
2007	Field peas	170.00	tonne

Figure 7.2.6 AFFIRM Crop Price Calculator

Field Recommendations

AFFIRM produces fertilizer recommendations for individual fields based on the crop selected, soil test information, previous crop history, soil zone, irrigation management and spring soil moisture (Figure 7.2.7). Fertilizer recommendations for N, P₂O₅, K₂O, and S are presented for dry, medium and wet moisture conditions.

Nitrogen recommendations are linked to the crop yield response and economic analysis. AFFIRM uses soil zone precipitation probabilities, spring soil moisture levels, soil test nitrogen and fertilizer nitrogen to calculate crop yield response. The crop yield response data in combination with crop prices, fertilizer nitrogen costs and investment ratio is used for the economic analysis to determine the optimum nitrogen fertilizer rate. The investment ratio (IR) is the ratio of the value of the expected yield increase from an additional 4.5 kg of fertilizer relative to the cost of the additional 4.5 kg of N fertilizer:

IR = Value of yield increase from additional 4.5 kg of N fertilizer (\$) ÷ Cost of additional 4.5 kg of N fertilizer (\$)

An IR greater than 1 indicates a profit is made (i.e., the additional yield produced from the extra fertilizer applied was enough to cover the extra fertilizer cost). An IR less than 1 indicates a loss, even though you may increase yield (i.e., marginal cost of fertilizer is more than marginal value of crop yield increase).

The user can change crop prices, fertilizer nitrogen costs, spring soil moisture conditions and IRs to test various cropping scenarios on fertilizer requirements. The economic analysis is presented in both tabular and graph formats.

AFFIRM provides alert messages to help with the interpretation of soil information. The messages will also help determine the impact on crop production and fertilizer management.

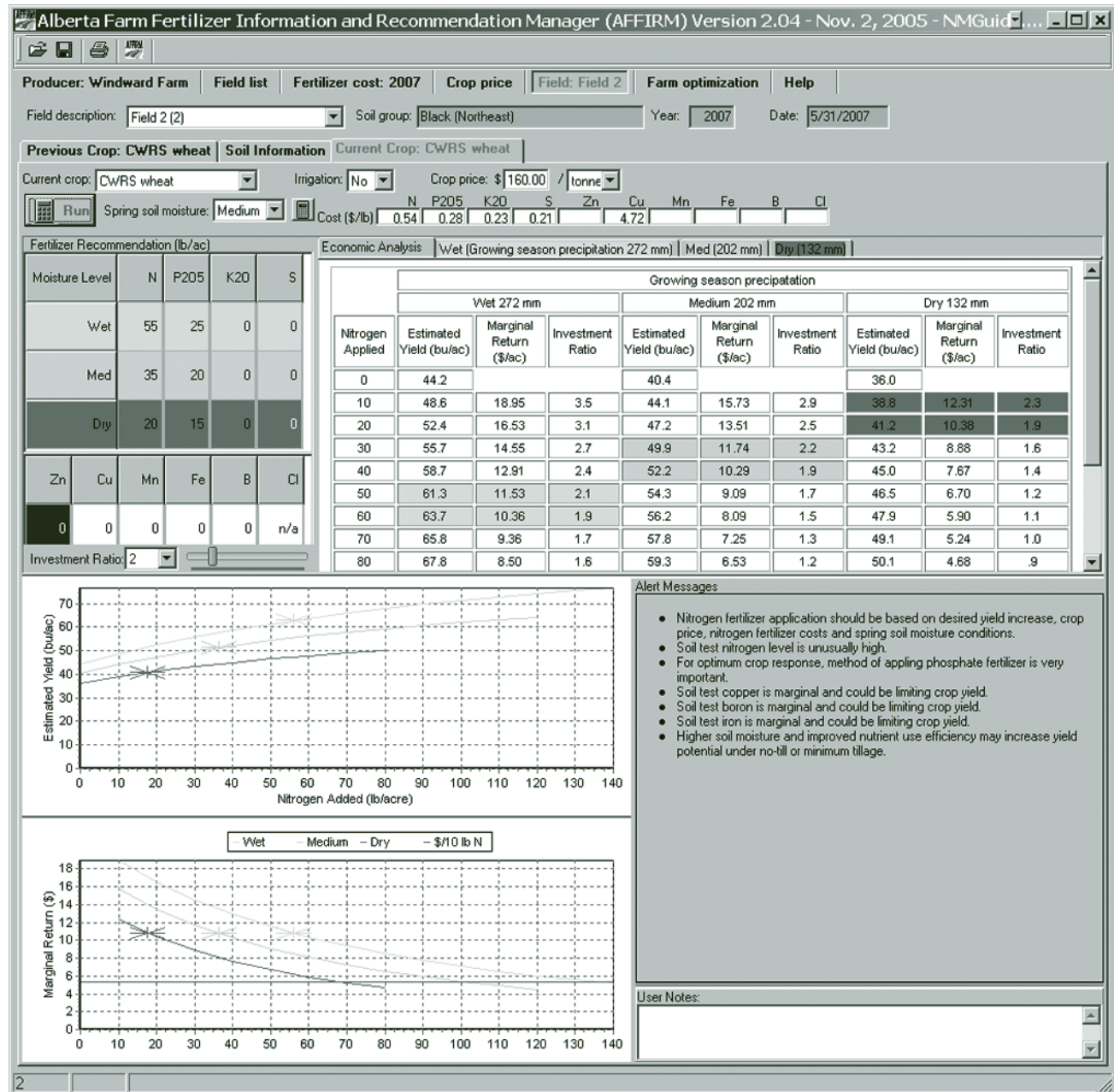

Figure 7.2.7 AFFIRM Field Recommendations

Farm Optimization

A unique feature of AFFIRM is the whole-farm fertilizer optimization function (Figure 7.2.8). The fertilizer budget for the entire operation needs to be entered into the program. AFFIRM then provides fertilizer recommendations per field with the aim of optimizing return on fertilizer investment.

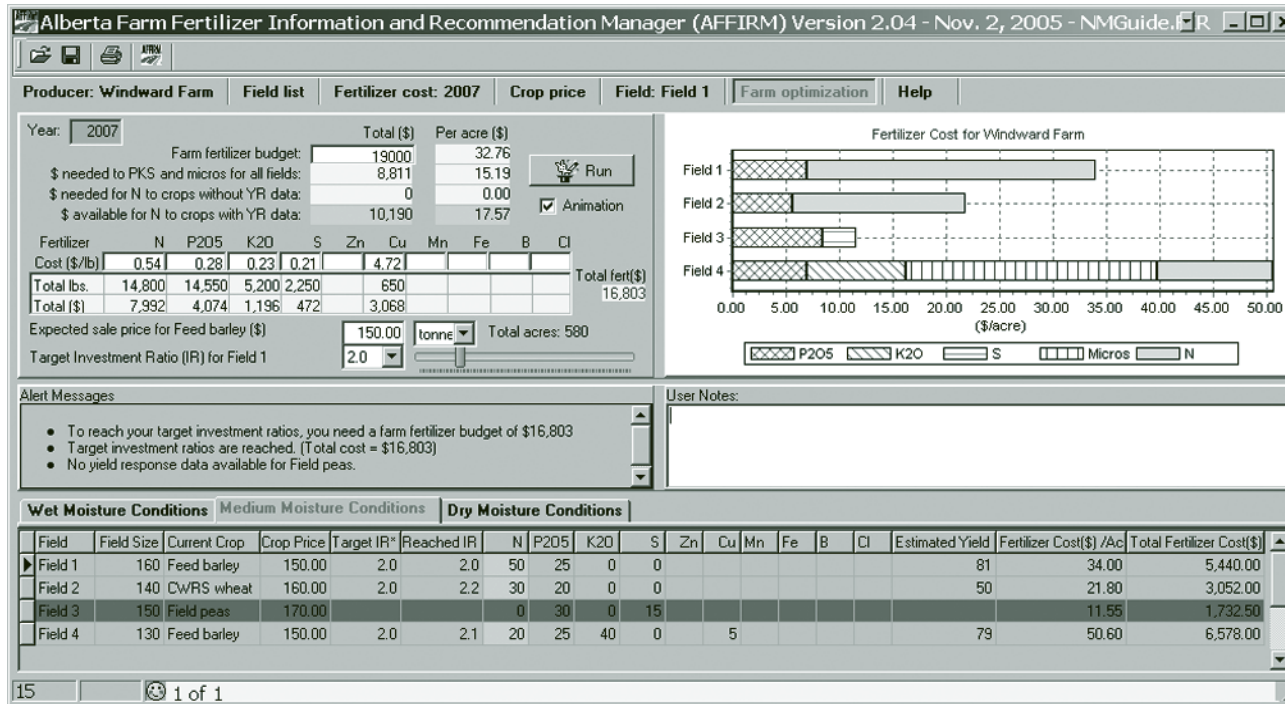

Figure 7.2.8 AFFIRM Farm Optimization Fertilizer Budget

tip



To get the latest version of MMP, go to [Ropin' the Web](#) and search keyword: Alberta MMP).

Guides and sample plans help you develop a nutrient management plan. For assistance in using MMP, contact Alberta's Ag-Info Centre toll free at 310-FARM (3276).

The end result of the AFFIRM optimization model is a whole-farm summary of where to allocate fertilizer, based on the farm fertilizer budget and the individual field and crop target investment ratios (Figure 7.2.9). Alert messages help to assess if the total budget allocated to achieve the target investment ratios is sufficient to cover fertilizer costs.

Alert Messages																	User Notes:	
<ul style="list-style-type: none"> To reach your target investment ratios, you need a farm fertilizer budget of \$16,803 Target investment ratios are reached. (Total cost = \$16,803) No yield response data available for Field peas. 																		
Wet Moisture Conditions			Medium Moisture Conditions			Dry Moisture Conditions												
Field	Field Size	Current Crop	Crop Price	Target IR*	Reached IR	N	P205	K20	S	Zn	Cu	Mn	Fe	B	Cl	Estimated Yield	Fertilizer Cost(\$)/Ac	Total Fertilizer Cost(\$)
Field 1	160	Feed barley	150.00	2.0	2.0	50	25	0	0							81	34.00	5,440.00
Field 2	140	CWRS wheat	160.00	2.0	2.2	30	20	0	0							50	21.80	3,052.00
Field 3	150	Field peas	170.00			0	30	0	15								11.55	1,732.50
Field 4	130	Feed barley	150.00	2.0	2.1	20	25	40	0	5						79	50.60	6,578.00

Figure 7.2.9 AFFIRM Farm Optimization Results and Alert Messages



Alberta MMP

The Alberta MMP software uses information about an operation's animals, manure storage, fields, crops and application equipment to plan manure applications (where, when, and how much). The software helps determine if an operation has sufficient total land base, seasonal land availability, manure storage capacity, and application equipment to manage its manure in an environmentally responsible manner. The Alberta MMP is based on Alberta soil, climatic and crop production information and is able to generate Alberta-specific reports, including record summaries that comply with AOPA record keeping requirements (refer to Chapter 7.1). The software gives the user the option of working in metric or imperial units.

Records and Inputs for Alberta MMP

The MMP program has a series of windows to input farm-specific information to develop a manure allocation strategy and prescribes manure application rates. MMP allows input of the following information:

- Producer and operation information
- Animal information
- Field description
- Livestock rations
- Field risk assessment
- Manure analysis information
- Soil analysis information
- Manure equipment information
- Crop information
- MMP recommendations
- Manure storage information
- MMP reports



Producer and Operation Information

The program requires general information about the operation including name, mailing address, contact information, county and length of the manure management plan (i.e., starting year, starting month, years in the plan) (Figure 7.2.10).

The screenshot shows the 'Manure Management Planner - SJ Farms Beef.mmp' window. The 'General' tab is active, displaying the following fields and values:

- Operation: SJ Farms
- Address: RR#1
- Town: Madden, Province: AB, Postal Code: T0T 0Y0
- Contact: Sandra Jones
- Office Phone: (403) 555-3434, Home Phone: (403) 555-2323
- E-mail Address: SJFarms@home.ca
- Notes: (empty text area)
- County: ROCKY VIEW (dropdown menu)
- Starting Year: 2003, Starting Month: September (dropdown menu), Years In Plan: 3

At the bottom of the window, there is a menu bar with buttons for New, Open, Close, Save, Save As, Tools, ? Help, About, and Exit. Below the menu bar is a status bar with the text 'Create a new manure management plan.'

Figure 7.2.10 Alberta MMP Producer and Operation Information



Field Description

The program requires information about each field (Figure 7.2.11). This includes field identification, total area, spreadable area, average slope (in % grade), predominant soil type, irrigation, and field ownership. The distance of the field from the manure source can also be entered, which will be used to prioritize fields for manure application.

Manure Management Planner - SJ Farms Beef.mmp

General Fields Assessment Soil Tests Crops Storage Animals Rations Analysis Equipment Nutrient Mgmt

Field ID	Subfield ID	Total Size (Acres)	Spreadable Size (Acres)	Storage Distance (Miles)	Predominant Soil Type (Name, Texture, Map Symbol, Slope Range)	Slope % (If Not Ave.)	Irrigated With Water
» A		102	60	1	ROCKYVIEW (RKV) SIL (ADRK1/UI 0.5-2%)		
B		106	105	1	ROCKYVIEW (RKV) SIL (ADRK1/UI 0.5-2%)		
C		97	95	1	ROCKYVIEW (RKV) SIL (ADRK1/UI 0.5-2%)		
D		82	82	1	ROCKYVIEW (RKV) SIL (ADRK1/UI 0.5-2%)		
E		195	195	1	ROCKYVIEW (RKV) SIL (ADRK1/UI 0.5-2%)		
F1		70	70	1	ROCKYVIEW (RKV) SIL (ADRK1/UI 0.5-2%)		
F3		86	33	1	ROCKYVIEW (RKV) SIL (ADRK1/UI 0.5-2%)		
G		47		1	ROCKYVIEW (RKV) SIL (ADRK1/UI 0.5-2%)		
H		117	117	1	ROCKYVIEW (RKV) SIL (ADRK1/UI 0.5-2%)		
I1		92	92	1	ROCKYVIEW (RKV) SIL (ADRK1/UI 0.5-2%)		
I2		93	93	1	ROCKYVIEW (RKV) SIL (ADRK1/UI 0.5-2%)		

Soil Info...

New Open Close Save Save As Tools ? Help About Exit

Create a new manure management plan.

Figure 7.2.11 Alberta MMP Field Description

Field Risk Assessment

The assessment window provides space to enter specific information that helps to characterize each field's natural risk of surface water contamination. Some of the information requested includes length of slope, presence of water bodies, presence of any conservation buffer strips and drainage. Although this information is not critical to developing manure application rate recommendations or allocating stockpiled manure, it can impact decision making for a particular field.

Soil Analysis Information

Soil analysis results for each field are used to calculate manure application rates (Figure 7.2.12). Space is provided to enter information for test year, organic matter content (%), P (along with the method that was used), K, Mg, Ca, Na, Al, soil and buffer pH, estimated or measured CEC, NO₃-N, EC and SO₄-S.



Manure Management Planner - SJ Farms Beef.mmp

General | Fields | Assessment | Soil Tests | Crops | Storage | Animals | Rations | Analysis | Equipment | Nutrient Mgmt

Field ID	Subfield ID	Test Year	OM (%)	P	P Test Used	K	Mg	Ca	Na	Al	Levels Are In Lb/A	Soil pH
A		2003	6.3	24	Modified Kelowna	228	548	2,370	71			7.3
B		2002	5.7	79	Modified Kelowna	425	333	1,791	16			7.2
C		2003	4.4	20	Modified Kelowna	215	554	2,647	59			7.5
D		2003	7.2	36	Modified Kelowna	357	511	2,657	55			7.5
E		2003	4.9	37	Modified Kelowna	261	619	2,711	137			7.7
F1		2003	6.8	36	Modified Kelowna	336	463	2,782	118			7.8
» F3			6.8	36	Modified Kelowna	336	463	2,782	118			7.8
G			7	15	Modified Kelowna	335	496	2,790	295			7.9
H		2003	7	15	Modified Kelowna	335	496	2,790	295			7.9
I1		2003	5.4	54	Modified Kelowna	324	587	2,503	123			7.5
I2		2003	6.8	129	Modified Kelowna	719	467	2,429	38			7.2

New Open Close Save Save As Tools ? Help About Exit

Enter the field's nitrate nitrogen level (or click the Calc button to calculate the depth-weighted average nitrate level).

Figure 7.2.12 Alberta MMP Soil Analysis Information



Crop Information

The planned rotation over the course of the MMP along with expected yields for each crop and year is entered using the 'Crops' window (Figure 7.2.13). If soil analysis information is unavailable MMP will use default N recommendations for the crop based on yield and soil zone.

Default fertilizer recommendations can be overridden by entering customized recommendations appearing on a soil analysis report or from some other source. The program also provides space to identify the source of the custom recommendations.

To account for N contributed by legume N-fixation, there is a column that allows entering the percentage of a forage stand made up of legumes.



Manure Management Planner - SJ Farms Beef.mmp

General | Fields | Assessment | Soil Tests | **Crops** | Storage | Animals | Rations | Analysis | Equipment | Nutrient Mgmt

Field ID	Subfield ID	Crop Year	Planned Crop (Or Second Crop If Double Cropping)	Yield Goal (/Acre)	Yield Units	Legume % Stand	Default N Rec (Lb/A)	Default P2O5 Rec (Lb/A)	Default K2O Rec (Lb/A)	Custom N Rec (Lb/A)
A		2004	Forage Grass-30% Legume	2	Ton	30	20	35	0	
A		2005	Forage Grass-30% Legume	2	Ton	30	20	35	0	
A		2006	Forage Grass-30% Legume	2	Ton	30	20	35	0	
B		2004	Forage Grass	2	Ton	0	60	0	0	
B		2005	Forage Grass	2	Ton	0	60	0	0	
B		2006	Forage Grass	2	Ton	0	60	0	0	
C		2004	Barley, Silage	6	Ton	0	100	10	0	
C		2005	Barley, Silage	6	Ton	0	100	10	0	
C		2006	Barley, Silage	6	Ton	0	100	10	0	
D		2004	Forage Grass	2	Ton	0	20	10	0	
D		2005	Forage Grass	2	Ton	0	20	10	0	

Buttons: New, Open, Close, Save, Save As, Tools, ? Help, About, Exit

Enter a phosphorus recommendation to use instead of the default (optional).

Figure 7.2.13 Alberta MMP Crop Information

MMP Recommendations

The 'Nutrient Management' window summarizes the recommended manure application rates by field, and allows the user to view the status of storage facilities and fields on a month-by-month basis (Figure 7.2.18).



Manure Management Planner - SJ Farms Beef.mmp

General | Fields | Assessment | Soil Tests | Crops | Storage | Animals | Rations | Analysis | Equipment | Nutrient Mgmt

Plan Month:	Sep 2003	Oct 2003	Nov 2003	Dec 2003	Jan 2004	Feb 2004	Mar 2004	Apr 2004	May 2004	Jun 2004
» Feedlot pile	769.4	3.6	478.6	773.6	1,068.6	1,363.6	1,838.6	2,313.6	609.4	1,068.6
Compost pile	581.5	7.0	48.5	90.0	131.5	173.0	214.5	256.0	-242.5	-200.0
Field pile	41.5	83.0	124.5	346.0	567.5	789.0	830.5	872.0	375.9	41.5

Field Status	Plan Month:	Sep 2003	Oct 2003	Nov 2003	Dec 2003	Jan 2004	Feb 2004	Mar 2004	Apr 2004	May 2004	Jun 2004
A		60 / 60									
B								F	105 / 105		
C			95 / 95								
D		82 / 82									
E									195 / 195		

Where Will Manure Be Applied?	Application Equipment	Days To Incorporate	Rate (/Acre) Calc...	Loads	Amount Applied	Area Covered (Acres)	Apply At Or For	Units	Avail N As Applied (Lb/A)
C (Barley, Silage '04 - Barley, Silage '03)	McKee Spreader	1	12	130	1,144	95.3	5,320	Feet/Load	102
M2 (Wheat, Winter '04 - Wheat, Winter '03)	McKee Spreader	1	8	5	44	5.5	7,990	Feet/Load	68
» F1 (Barley, Silage '04 - Barley, Silage '03)	McKee Spreader	1	11	6	52.8	4.8	5,810	Feet/Load	94

New | Open | Close | Save | Save As | Tools | ? Help | About | Exit

Figure 7.2.18 Alberta MMP Recommendations



The MMP software can generate several reports that serve as manure management plans, and can also generate completed forms that comply with record keeping specifications under AOPA (Figure 7.2.19).

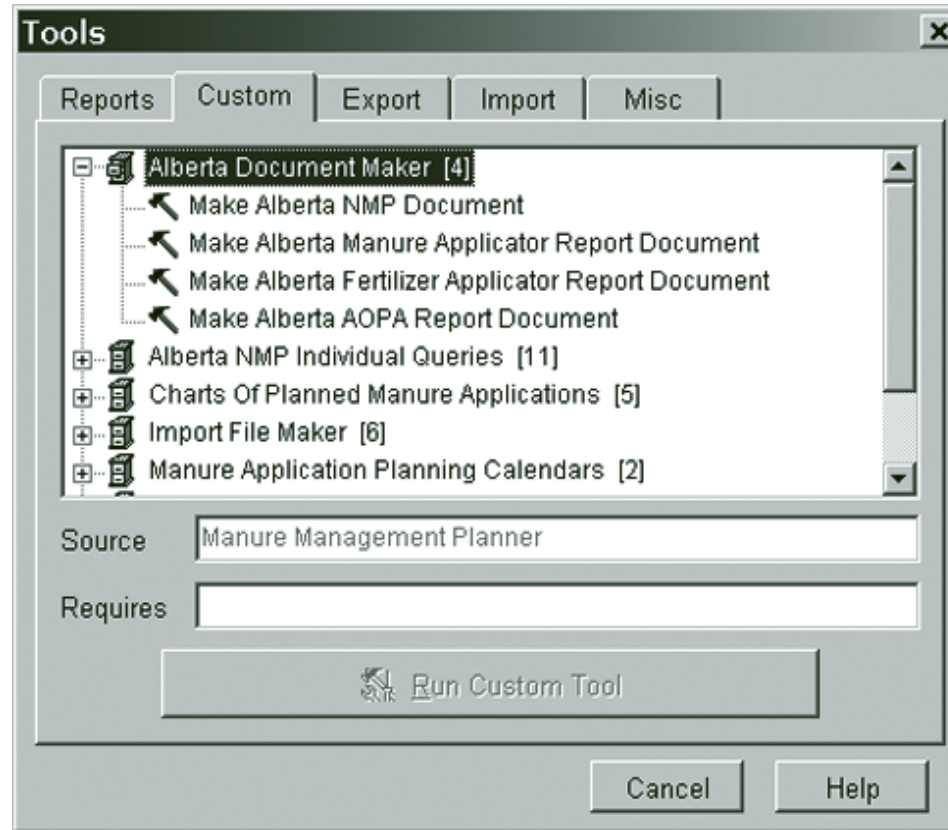

Figure 7.2.19 Alberta MMP Custom Reports Options

summary

- The AFFIRM software generates a fertilizer use strategy for an operation based on soil analysis, moisture conditions and production economics for selected crops with the goal of optimizing return on investment in fertilizer.
- **AFFIRM provides individual field fertilizer recommendations and whole farm optimization summaries based on budget limits and production economics.**
- The Alberta MMP software uses information about an operation's **animals, manure storage, fields, crops** and application equipment to plan manure applications. The software helps **determine if an operation has sufficient total land base, seasonal land availability, manure storage capacity and application equipment to manage its manure in an environmentally responsible manner.**
- **The MMP software will prioritize fields for manure application based on cropping strategy and distance from the storage facility. It also has the ability to generate several different reports, including completed forms that comply with AOPA standards for manure management record keeping.**

Chapter 8.1

Factors Affecting Runoff Nutrient Losses

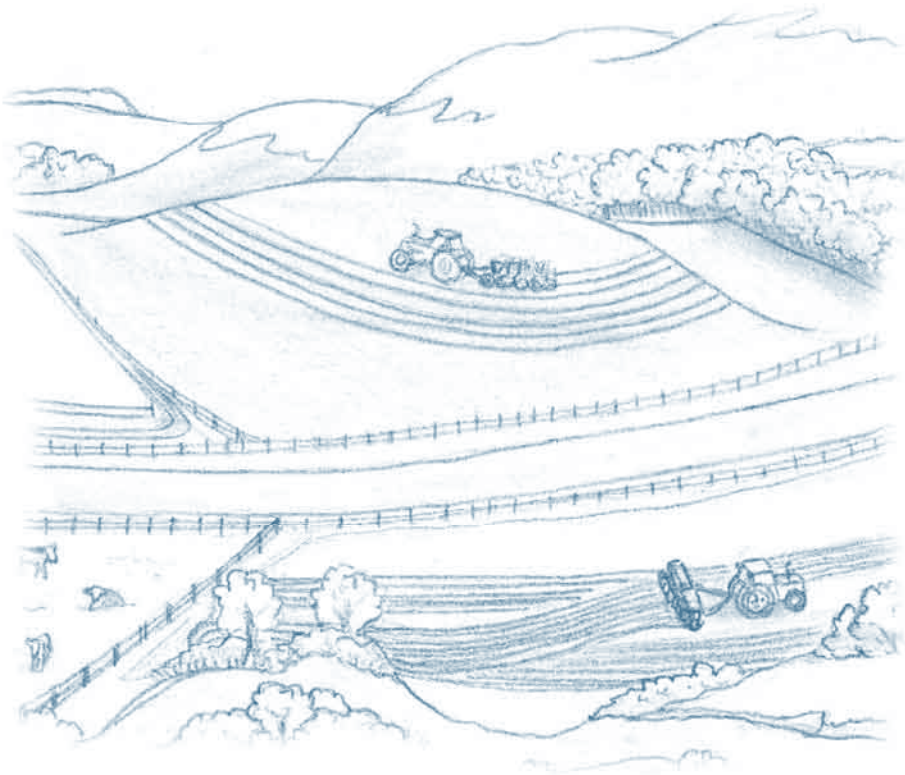

➔ learning objectives

- Explain how runoff, soil erosion and nutrient loss are related.
- Identify the factors that influence soil and nutrient erosion losses due to runoff.



Important Terms

Table 8.1.1 Key Terms and Definitions

Term	Definition
Infiltration	Is the process by which water on the ground surface enters the soil.
Fissures	Physical cracks in soil caused by the loss of water or frost action.
Erosive Energy	The ability of flowing water to detach and transport soil particles. The erosive energy of running water depends on its volume and velocity.
Surface Runoff	A term used to describe the flow of water, from rain, snowmelt, or other sources, over the land surface. It is part of the water cycle.
Water Holding Capacity	Describes the total amount of measurable water that can be retained in a soil profile, and held against gravitational pull.

Runoff is that portion of total precipitation (rain and snow) that does not infiltrate into the soil but instead flows over the soil surface. Snowmelt is responsible for more than 80% of runoff that occurs in Alberta. Runoff can transport nutrients from the field reducing the amount of nutrients available to support crop production. Nutrient-enriched runoff also contributes to accelerated eutrophication of surface water bodies, which can decrease water quality (Chapter 2.3).

Soil nutrients are lost through runoff in two main ways:

- Nutrients in soil solution can be lost as dissolved forms in runoff.
- Sediments carried in runoff can transport nutrients associated with soil mineral particles or organic matter complexes.

The application of nutrients, in excess of crop requirements, or at times when the crop is not using nutrients leads to accumulations of nutrients that can be lost to runoff. To minimize nutrient losses in runoff, apply manure and fertilizer at rates and times that coincide with periods of greatest crop uptake.

Aside from altering the rate and timing of nutrient application, it is difficult to design strategies that effectively target dissolved nutrient losses. Many of the

practices used to control water erosion can also reduce sediment-bound nutrient losses.

This chapter will look at factors that influence the occurrence and erosive potential of runoff. The two chapters that follow will focus on specific strategies and control measures that target these factors to reduce the risk of nutrient loss in runoff.

Timing, Rate and Form of Precipitation

Precipitation from rainfall and runoff from snowmelt are the driving factors for soil erosion. An understanding of how the timing, intensity and form of precipitation and runoff affect runoff potential will help in the design of strategies to control runoff and water erosion.

Timing and Rate

Timing and rate of precipitation are critical factors affecting runoff. High intensity storms will cause more runoff than low intensity storms. For example, considerable runoff may occur on a site that receives 50 mm of rain in one or two short, severe storms versus if the same volume of rain was to fall on the same site over the course of a week in several intermittent showers.

Likewise, a slow, steady springmelt event is associated with less erosion than a fast springmelt event, which may release a large quantity of water over a short period of time.

The condition of the soil at the time of rainfall or runoff is also important. Wet soils generally have lower infiltration rates than dry soils since pore spaces are already filled with water. In addition, certain types of clay swell upon wetting, which reduces the size and number of pores or small channels in the soil making it more difficult for subsequent precipitation to infiltrate.

The state of the soil at the time of the first major snowfall (i.e., snow remains until the following spring) also has an important influence on the amount and extent of runoff from a site (Figure 8.1.1).

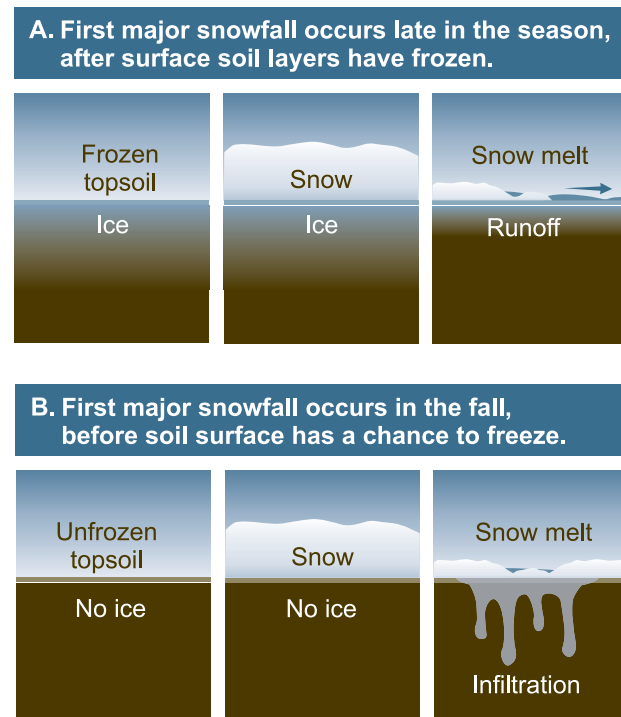

Figure 8.1.1 Effect of Timing of First Major Snowfall on Runoff

In the first scenario (Figure 8.1.1A), the first major snowfall occurs late in the year (e.g., mid to late November) after surface soil layers have frozen. The snow cover insulates the frozen ground resulting in increased runoff during spring thaw since the ground remains largely impermeable. In the second scenario (Figure 8.1.1B), the first major snowfall occurs earlier in the year (e.g., early to mid October). The insulation properties of the snow cover influence the extent to which ice crystals form in the surface layers of the soil. The result can be less runoff during spring thaw since surface soil has greater permeability to infiltration of melt water.

Forms of Precipitation

The majority of Alberta's surface water runoff is generated by snowmelt. Snowmelt runoff usually occurs in the early spring (March to April) as daytime temperatures warm to above zero. The water released from the melting snow is unable to infiltrate into partially or completely frozen soil resulting in surface water flow or runoff. This increases the risk of snowmelt water flowing from fields into surface water bodies compared to runoff from rainfall.

Water infiltration dynamics during snowmelt into thawing soils are complex. An important factor is the moisture content of the soil at the time of freezing. Soils that have drained prior to freezing allow greater water infiltration. Soils that were saturated at the time of freezing will have formed ice crystals, which effectively plug soil pores. Soil structure can be degraded in frozen saturated soils as aggregates break down from the force exerted by expanding water as it freezes. The resulting degradation of soil structure results in slower drainage and less water infiltration.



more info



To learn more about RUSLE and application to Canadian conditions, consult the following online document from Agriculture and Agri-Food Canada (AAFC):
 Wall, G.E., Coote, D.R., Pringle, E.A. and Shelton, I.J. (Eds). 1997. Revised Universal Soil Loss Equation for Application in Canada: A Handbook for Estimating Soil Loss from Water Erosion in Canada. http://res2.agr.ca/CRECO/pubs/pdf/rusle_e.pdf



Rainfall can be a source of runoff and erosion. The potential for rainfall to create runoff depends on soil conditions (e.g., frozen versus thawed), soil type, rainfall intensity and volume, slope, ground cover, the soil's water holding capacity and the soil's structural integrity (e.g., compacted or not). Some of the most erosive events in Alberta have occurred due to large rainfall events that have overwhelmed the capacity of existing drainage paths, waterways and soil to absorb and hold water and maintain structure.

The Revised Universal Soil Loss Equation (RUSLE)

The Revised Universal Soil Loss Equation (RUSLE) lists the main factors that contribute to soil erosion. An understanding of these factors and how they affect soil erosion helps with the design of sound strategies to control runoff. The Universal Soil Loss Equation (USLE) was developed in the United States in the mid 1960's, and was revised (RUSLE) for Canadian conditions in the 1990's to estimate soil losses due to surface runoff:

$$A = R \times K \times L \times S \times C \times P$$

Where,

A = soil erosion loss in tonnes/hectares

R = rainfall factor

K = soil erodibility factor

L = length of slope factor

S = slope factor

C = cropping system/ground cover factor

P = management practices factor

Soil Properties

Soil properties (e.g., texture, structure and soil organic matter) affect the size and amount of soil pores, and determine how easily water infiltrates and is held in the soil. Larger soil pores and fissures present in coarse textured soils generally allow faster infiltration while water infiltrates more slowly in fine textured soils.

Soil Structure

Well-structured soil with stable aggregates and an extensive network of pores allows water to infiltrate much easier than a poorly structured, compacted soil. Organic matter in a soil also influences infiltration in a couple of ways:

- Organic matter (especially coarse organic matter) is extremely porous so it allows water to infiltrate relatively easily.
- Organic matter enhances soil aggregate stability, which helps the soil to resist particle detachment by erosive forces and also promotes infiltration.

Soil Water Holding Capacity

The soil's ability to handle water once it has infiltrated (i.e., water holding capacity) is determined by texture and organic matter content. Medium textured soils generally have the highest plant-available water content (Figures 8.1.2, 8.1.3). Organic matter content is positively related to water-holding capacity of the soil since organic materials act like a sponge and can absorb several times their dry weight in water. Increased water holding capacity reduces the potential for erosion that can occur as a result of poor soil structure or texture (e.g., eroded soils, low organic matter soils).

While soil texture cannot be controlled, management and cropping practices can have an important impact on soil properties. Practices that retain or build organic matter and improve soil structure will improve the infiltration and water-holding potential of the soil.

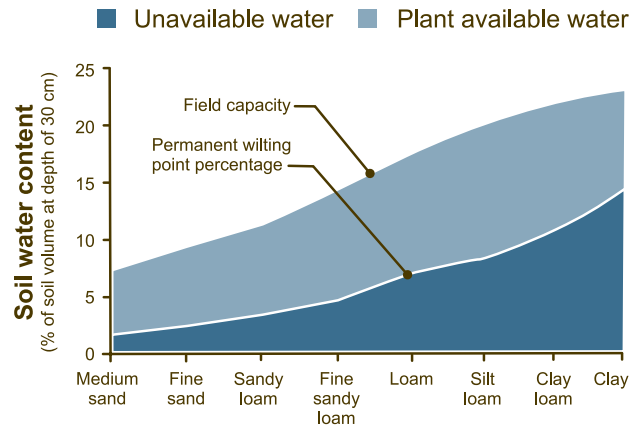

Drawn from data presented in Miller and Donoghue, 1990
Figure 8.1.2 Effect of Soil Texture on Soil Water Holding Capacity

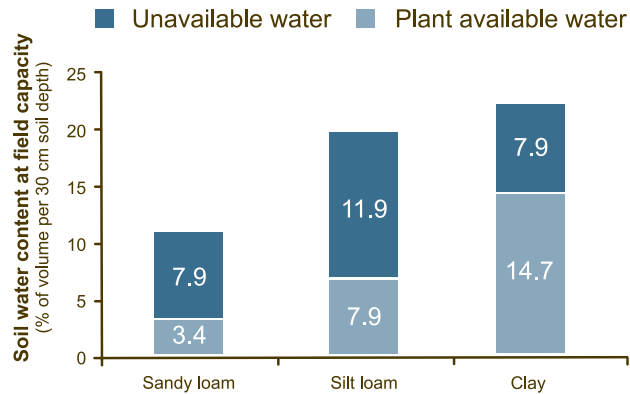

Drawn from data presented in Miller and Donoghue, 1990
Figure 8.1.3 Water Holding Capacities of Three Soils at Field Capacity

Slope

Soil slope has an important effect on runoff since a higher level of erosive energy is generated by water moving over steep slopes than by water moving over shallow slopes. Although precipitation and soil properties cannot be managed, there are management practices designed to reduce water erosion potential by interrupting the uniformity of the slope or by breaking slopes up into shorter segments. These act to slow down the runoff reducing the energy that can be used for erosion and allowing the soil particles suspended in runoff to be deposited back onto the soil.

Length and the grade of a slope influence potential soil (and therefore nutrient) loss. Simulations using the Water Erosion Prediction Project (WEPP) software with Alberta data demonstrate that the volume of runoff (measured as depth of runoff) increases as a product of slope length and grade (Figure 8.1.4).

WEPP

The WEPP model was developed in the United States through a collaborative effort between the Agricultural Research Service of the United States Department of Agriculture (USDA-ARS), the National (US) Soil Erosion Laboratory (NSERL) and Purdue University. It is designed to predict soil erosion losses at a field scale. The model incorporates soil, slope and climatic information to allow the user to see how management factors such as filter strips impact on soil losses.

To download and/or learn more about the WEPP model and its applications, you can visit the USDA-ARS website www.ars.usda.gov/main (search keyword: WEPP or NSERL).

side bar

The proportion of water available for plant use when a soil is moist but not saturated (i.e., at field capacity) will vary according to organic matter content, pore space and soil texture.



more info



For information on the soil temperature issue in direct seeding systems, consult the following resource, available from the **AF Publications Office (1-800-292-5697)** or search by Agdex number on Ropin the Web.

- Froebel, B. and Howard, A. 1999. Soil temperature and direct seeding. **AF. Agdex 590-2.**



—x— 50 m slope length —o— 200 m slope length —□— 500 m slope length

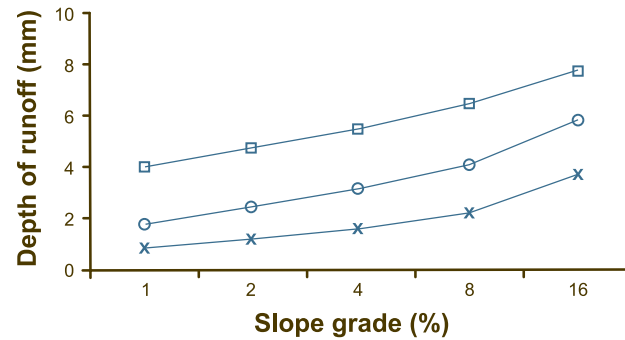

Provided by Andy Jedrych, AF

Figure 8.1.4 Predicted Runoff Volume (measured as runoff depth as a function of slope grade for slopes 50 m, 200 m and 500 m in length). From data generated for a WEPP simulation for a loam textured soil in central Alberta climatic conditions.

The volume of runoff from a site increases with increased grade and increased length of slope. An increase in the grade of the slope increases the gravitational force on water and, depending on soil factors (i.e., permeability, texture, etc.), may increase its tendency to flow along the surface rather than infiltrate into the soil. The relationship between runoff and soil/nutrient loss is illustrated in Figure 8.1.5.

Generally, the longer and steeper the slope the greater the sediment loss will be (Figure 8.1.5). In addition, soil loss is a function of soil texture, land use (e.g., crop type and stage, tillage regime) and climatic conditions. The energy of the water to detach sediment particles from the soil surface increases as the volume and intensity of the runoff increases.

—x— 50 m slope length —o— 200 m slope length —□— 500 m slope length

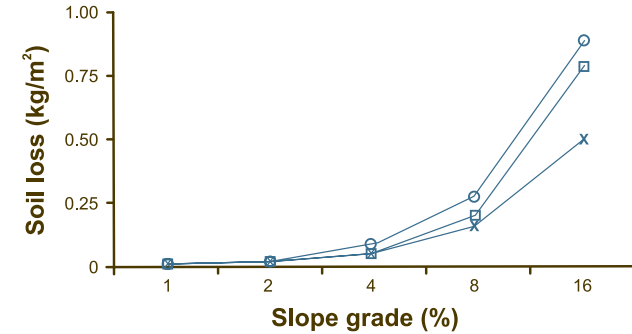

Provided by Andy Jedrych, AF

Figure 8.1.5 Predicted Surface Soil Loss, kg/m² as a Function of Slope Grade (for slopes 50 m, 200 m and 500 m in length). From data generated for a WEPP simulation for a loam textured soil in central Alberta climatic conditions.

Vegetation or Ground Cover

Many erosion control measures provide ground cover to protect the soil. It is particularly useful if ground cover is maintained high-risk periods such as during snowmelt runoff. Ground cover limits runoff by providing a physical barrier, which also increases the chance for runoff to infiltrate. Vegetative cover also serves as a filter to increase the removal of particles from runoff. Ground cover can be present in the form of living plants or as residue from the previous crop (Figure 8.1.6).

Vegetation and ground cover have several important effects on rainfall and runoff water:

- **Raindrop Buffering Effect.** Plants or plant residues reduce the impact of raindrops on the soil by intercepting raindrops and absorbing much of the energy. When raindrops strike bare soils, they can fracture soil aggregates and cause smaller particles to wash into and effectively plug soil pores. This reduces the permeability of surface soil layers resulting in reduced water infiltration.
- **Soil Channelling Effect.** Small channels created by intact stems and roots can serve as tiny “pipelines” that facilitate water movement into the soil. This effect is enhanced when a living canopy of leaves is present as these serve to direct precipitation towards the stem in a process referred to as “stem flow”.
- **Reservoir Effect.** Ground cover serves as a sort of in-field “reservoir” delaying the movement of water off the field and allowing more time for water to infiltrate. The stems of plants or standing crop residues serve as a physical barrier to water movement while vegetative debris on the surface may absorb some of the water and release it gradually so that it can be absorbed over a longer period of time.

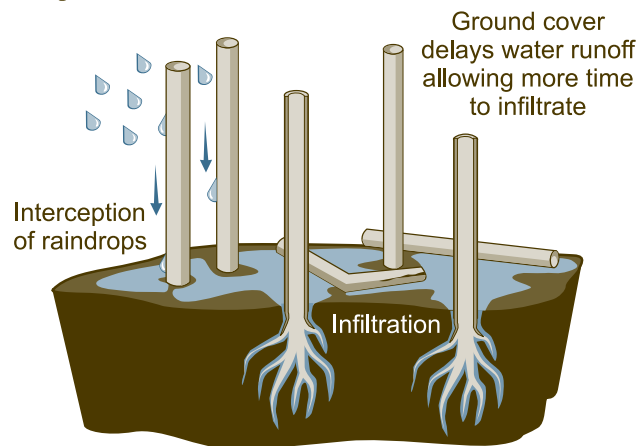

Figure 8.1.6 Ground Cover Enhances Water Infiltration and Control Runoff

Crop Residues and Soil Temperature

Crop residues reduce the severity of runoff in the spring by serving as a barrier against runoff as well as improving runoff infiltration into the soil. Crop residues left on the soil surface also trap snow, which serves as an insulation buffer against extremes in soil temperature. The cooler, moister conditions that result can delay seeding in direct seeding or reduced tillage management systems since the soil warms more slowly in the spring.



➔ summary

- Runoff and water erosion can transport **nutrients from the field either dissolved** in solution or associated with soil particles reducing the amount of nutrients available to support crop production.
- Precipitation patterns are a major factor in the generation of runoff. Most of the runoff in Alberta is generated by snowmelt.
- Timing and rate of precipitation are critical factors affecting runoff. High intensity storms will cause more runoff than low intensity storms.
- The condition of the soil at the time of rainfall or runoff is also important. Wet soils **generally have lower infiltration rates than dry soils since pore spaces are already filled with water.**
- Soil properties including texture, structure and organic matter content have **important influences on the permeability of a soil to water and its ability to hold water once it has infiltrated.**
- **Length and grade of slopes in a field** impact soil erosion and therefore nutrient losses. Several runoff control practices are designed to interrupt the continuity of **slopes to interfere with free-flow of runoff** down slope.
- Ground cover in the form of vegetation or crop residue can reduce erosion and nutrient losses by providing a physical barrier and protecting the soil surface from the erosive energy of rainfall, snowmelt and **concentrated flow.**

Chapter 8.2

Cropping Practices to Reduce Nutrient Losses in Runoff

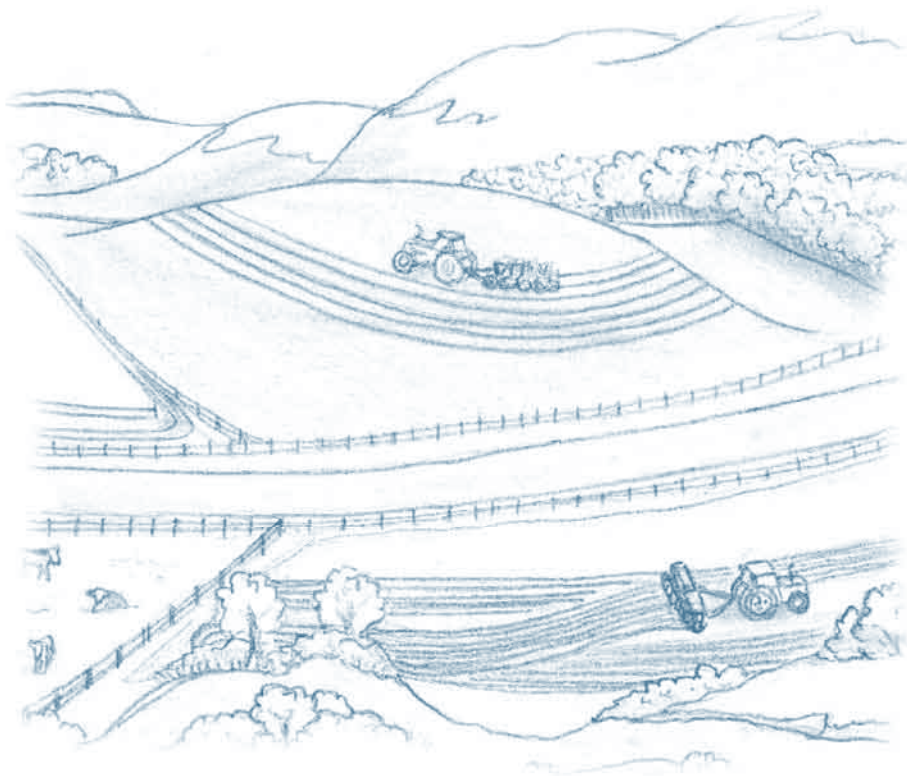

➔ learning objectives

- List four practices of managing manure application that can reduce nutrient losses in runoff and briefly explain how these practices reduce the loss of runoff.
- List two cropping practices to deal with slope concerns on sites at risk for erosion or nutrient losses in runoff.
- List at least five cropping practices that can be used to provide ground cover on sites at risk for erosion or nutrient losses in runoff and briefly explain how they reduce risk.

more info



This chapter is meant to provide an overview of the erosion control

benefits of selected practices. For more details about these practices consult the suggested references for each topic, contact Alberta's Ag-Info Centre, or contact a qualified consultant or service provider.



Important Terms

Table 8.2.1 Key Terms and Definitions

Term	Definition
Contour	Following the lay of the land perpendicular to direction of the slope.
Crop Biomass	The total plant matter produced by the crop (i.e., straw, roots and seed).
Direct Seeding	In this cropping system, no tillage operations are completed prior to the seeding of the crop. Generally, the crop is seeded directly into the stubble of the previous crop.
Percolates	The movement and filtering of fluids through porous materials (i.e., soil).
Reduced Tillage	In this cropping system, tillage operations are minimized leaving most of the plant residue on the soil surface. The primary tillage operation is seeding. The amount of soil disturbance varies with the equipment used. Reduced tillage systems replace most weed control tillage operations with herbicide applications.
Terraces	A leveled section of a hilly cultivated area designed as a method of soil conservation to slow or prevent the rapid runoff of surface water.
Zero Tillage or No-Tillage	This is a conservation cropping system in which the only operation that disturbs the soil is seeding and any simultaneous fertilizer application. While the amount of soil disturbance varies with the equipment used, in most practical situations only 10 to 30 % of the soil is disturbed.

This chapter will focus on management practices that are designed to prevent nutrient losses in runoff, primarily through addressing ground cover and slope. The practices discussed in this chapter generally do not require additional, specialized equipment and are cost-effective in contrast to installing more intensive runoff control measures, which are discussed in Chapter 8.3.

Manure application and no-tillage situations can increase the occurrence of nutrients on or near the soil surface and subsequently increase the amount of potential dissolved nutrients in water. Management practices that take into account the characteristics of runoff can be adopted to minimize the potential nutrient loss due to runoff. Practices that are effective at reducing nutrient losses from a field either reduce the source of nutrients on or close to the soil surface or reduce the flow of runoff.

Practices designed to reduce water erosion and nutrient losses from runoff generally fall into:

- Practices that manage the application of manure
- Practices that attempt to disrupt the continuity of a slope
- Practices that maintain or enhance ground cover
- Practices that reduce soil compaction

Practices that Manage the Application of Manure

Avoid Applying Manure on Snow-covered or Frozen Ground

Manure spread on snow-covered or frozen ground is in direct contact with snowmelt runoff water increasing the risk of nutrient transport. Higher levels of nutrients have been measured in runoff from land where manure was winter-applied as compared to non-manured land. Eliminating or minimizing winter application of manure reduces the chance of nutrient loss during runoff.

To eliminate the need for winter application, producers may have to increase their manure storage capacity. Adequate storage is required to contain the manure produced during the winter months and allow for application at more appropriate times. This may require the construction of larger and more costly manure holding facilities than presently used by some producers. Alternatively, a small group of producers may work together to construct and share a larger storage facility. This approach reduces the costs associated for individual farms while providing the benefit of an increase in storage capacity.

Apply Manure to Meet Crop Nutrient Requirements

Crops require approximately three to seven times the amount of N than they do P. As a result, applications of manure, which may have a 2:1 or even a 1:1 ratio of N to P can result in the over-application of P. The over applying of P above crop need results in the build-up in the soil. Applying fertilizer and manure at rates that meet crop nutrient requirements will reduce the risk of nutrient build-up in the soil. By reducing the concentration of nutrients on or near the soil surface, the amount of nutrients available for transport in runoff water will be reduced.

A significant implication to applying manure based on P requirements is the affect on land requirements and transportation costs. Since crops use significantly less P than N, a larger land base maybe required for manure application based on P requirements compared to N requirements. Operators may need to purchase more land, rent additional land or build partnerships with surrounding landholders to secure the land-base required for a P-based manure application program. An expanded land base may also result in increased transportation costs if manure has to be hauled greater

distances. Other manure management strategies such as composting or generating bio-fuels may offer alternatives to transportation.

A NMP may be adopted that calculates manure application rates based on multi-year crop P demands matching P uptake to crop removal in a rotation over three to five years. Operations may need to improve their MMP and feeding strategies to either reduce the opportunity of N loss from the manure or increase the amount of P retained in the animal to maintain a higher N to P ratio. Manure with a higher N to P ratio provides a better nutrient balance for crops, making it easier to manage and reduces the risk of P accumulation.

Time Manure Application to Maximize Crop Uptake

Apply manure just prior to seeding or as close as possible to the time of active crop growth. Nutrients from the manure application can be used and taken up by the crop reducing the opportunity for loss from the system. The crop canopy will also provide protection from erosion and loss by rainfall and volatilization. Application on unfrozen surfaces increases the opportunity for the movement of dissolved nutrients into the soil through water infiltration. In addition, there is a greater opportunity for spring applied nutrients to be absorbed by the soil compared to late fall manure applications reducing the risk to surface runoff losses. Avoid application without incorporation of manure in the late fall as this increases the risk of nutrient loss during spring snowmelt.

The challenge to early season manure application is time, conflict with spring seeding and the risk of soil compaction if soils are wet. Custom applicators may be used to manage time constraints. Field and crop selection are important considerations when managing seeding and manure application. Select crops that will be seeded





later in the season such as warm season crops, silage or fall cereals. Manure may also be applied to forage and pasture crops or injected between forage cuts. This increases the opportunity for manure application when the soil is drier reducing the risk of soil compaction while providing nutrients when needed the most. If manure must be applied in late summer or fall, select fields that are a low risk for snowmelt water runoff to reach surface bodies of water.

Incorporate or Inject Manure

The incorporation or injection of manure can reduce the exposure of manure to surface runoff events reducing the opportunity for dissolved nutrients to be carried from manured fields to adjacent bodies of surface water. In Alberta, manure must be incorporated within 48 hours of application unless it is applied to forage, reduced tillage systems or on frozen or snow covered ground (Chapter 4.4).

While incorporation does not fit well with perennial crops, direct seeding or no-tillage farming operations, the low disturbance liquid manure injection technologies have been shown to work well with these systems. Injection technologies allow for the direct placement of liquid manure into standing forages or stubble fields with minimal disturbance.

Alternatively, high disturbance tillage can be used to incorporate surface applied liquid or solid manure. Although tillage can be an effective means to incorporate manure, the negative consequences associated with tillage include reducing the amount of protective crop cover residue and the breaking up soil structure. The result can reduce the snow trapping ability of the field and lead to a greater risk of soil loss to erosion by water

and wind. However, some of the negative effects will be offset by manure application since organic matter in manure can protect the soil surface from erosion, promote water infiltration and improve soil structure.

Practices to Deal with Slope

The primary way to control runoff on problem slopes is to disrupt slope uniformity using practices such as farming on the contour or maintaining permanent ground cover. These practices generally work best on slight to moderate slopes (e.g., < 6 or 7 %) that are relatively uniform. For sites where runoff flow patterns are more concentrated, a combination of practices described in this chapter with more intensive constructed erosion control measures described in Chapter 8.3 may be required.

Farm on the Contour

Farming on the contour refers to performing field operations across the slope along the shape (or contour) of the land. This results in a series of small ridges and furrows that act as micro-terraces or obstacles to water attempting to flow down the slope. Field operations on the contour can be done to direct water flow toward an outlet such as a grassed waterway thereby providing additional runoff control and soil protection (Figure 8.2.1).

Generally, contour farming dramatically reduces erosion on gentle slopes but is less effective on steeper slopes. The presence of ground cover (e.g., standing crop residue) increases the effectiveness of contouring.

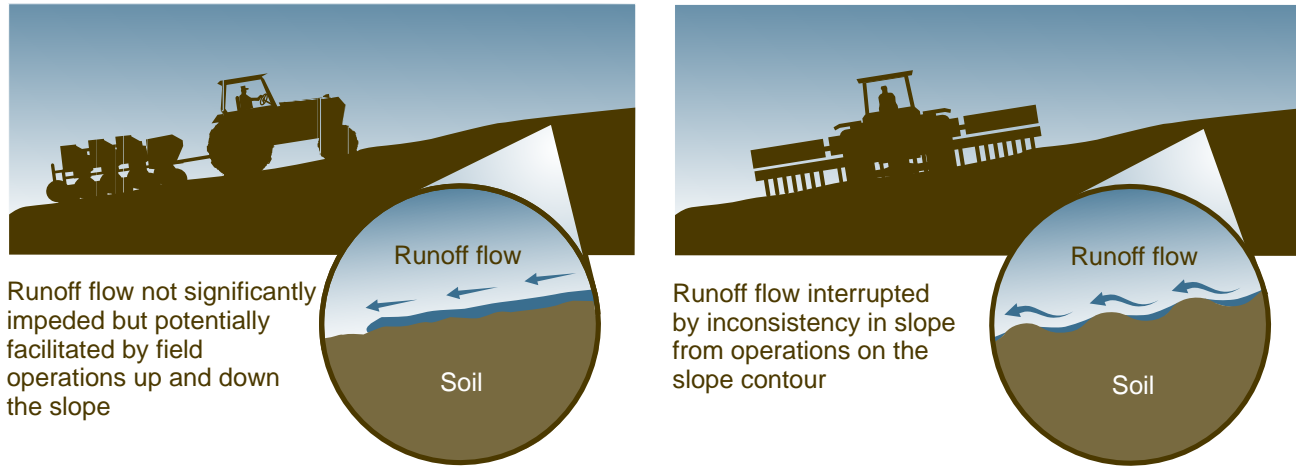

Runoff flow not significantly impeded but potentially facilitated by field operations up and down the slope

Runoff flow interrupted by inconsistency in slope from operations on the slope contour

Source: Hirschi et al., 1997

Figure 8.2.1 Slope Disruption Resulting from Farming on the Contour

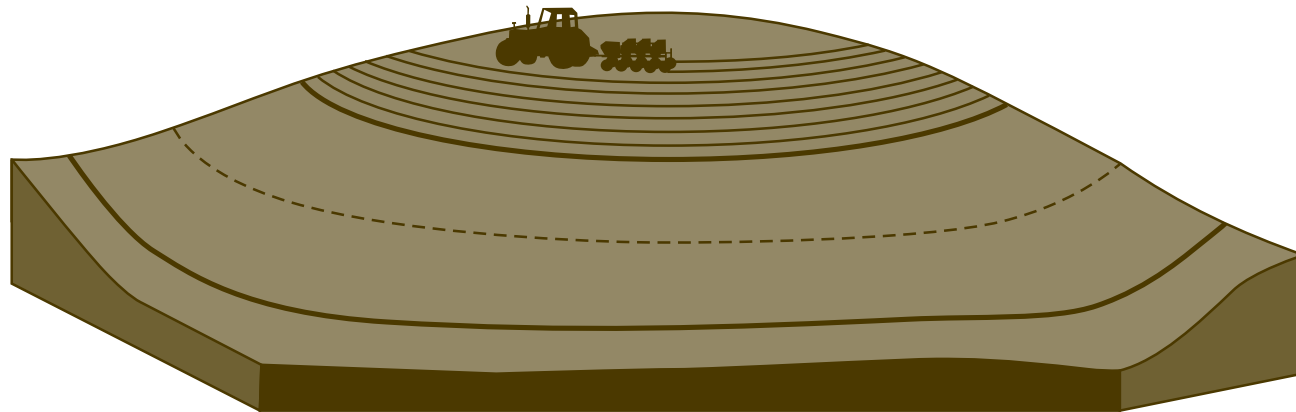

Source: Hirschi et al., 1997

Figure 8.2.2 Example of Farming on the Contour

sidebar

The effectiveness of farming on the contour on its own diminishes as slope length increases and the amount of residue or ground cover present decreases.

more info



To get more information about farming on the contour, consult the following online document:

USDA-NRCS. 2000. Contour farming. National Conservation Practice Standard #330. Electronic Field Office Technical Guide. United States Department of Agriculture – Natural Resource Conservation Service. <ftp://ftp-fc.sc.egov.usda.gov/NHQ/practice-standards/standards/330.pdf>

more info



For recommended minimum levels of crop residue to

minimize erosion (based on slope grade and length for various cropping systems and soil types), see the following online document from AF.

AF. 2005. A method for developing best management practices to prevent water erosion on farmland using WEPP. CAESA Soil Quality CSQ Research Factsheet 11. [www1.agric.gov.ab.ca/\\$department/deptdocs.nsf/all/sag5804](http://www1.agric.gov.ab.ca/$department/deptdocs.nsf/all/sag5804)

tip



For crop residue to retain snow-catching effectiveness it is

important that any fall soil disturbances minimize stubble knockdown and keep most of the crop residue on the surface.

Practices to Maintain or Enhance Ground Cover

One of the best ways to reduce erosion is to protect the soil surface with a cover of growing plants or crop residue. Surface cover cushions the impact of raindrops so soil particles are not as easily dislodged and moved. It also slows the flow of runoff giving the soil time to absorb more water thereby reducing the total volume of runoff and risk of erosion and nutrient loss.

Crop residues and roots stabilize soil aggregates, enhance infiltration and add to soil organic matter, which increases soil water holding capacity. Ground cover also provides insulation to the soil buffering against changes in soil temperature. This has important implications for runoff resulting from snowmelt (see Chapter 8.1).

Tillage Systems

Under conventional tillage management, there are several negative impacts including reduced soil moisture reserves, increased wind and water erosion risk, disruption of soil structure, accelerated organic matter decomposition, and depending on the implement used, compaction of sub-surface soil layers.

Conservation tillage systems have been promoted in western Canada for several decades. Conservation tillage is a general term that refers to several systems including zero tillage (zero-till), direct seeding and reduced tillage. All of these systems increase the amount of crop residue left on the soil surface and all have the same goal: to minimize erosion risk and conserve soil moisture.

Minimizing the Negative Impacts of Tillage

- Avoid fall tillage so ground cover is retained to trap snow and prevent soil erosion during the fall, winter and spring.
- Replace deep tillage with shallow tillage to minimize disturbance of soil.
- Reduce the number of tillage passes.
- Reduce tillage speed.
- Use implements that bury less crop residue (Table 8.2.2).
- Where possible, run tillage and seeding operations across the slope (as opposed to up and down the slope) to prevent runoff from eroding channels down the slope.
- Avoid field operations when the soil is wet.

Table 8.2.2 Residue Left by Various Tillage Implements

Tillage Implement	% Residue Left After One Pass	% Residue Left After 4 Passes
Wide-Blade Cultivator	90	60 - 65
Chisel Plow with Low-Crown Shovel	85	40 - 45
Chisel Plow with Normal Shovels	80	35 - 40
Chisel Plow with Normal Shovels Plus Mounted Harrows	60	10 - 15
Heavy Tandem or Offset Disc	35 - 65	5 - 15
Moldboard Plow	0 - 10	0

Source: AF

Fallow Systems

» Negative Impacts of Fallow

- Fallow systems result in decreased organic matter levels with time since little plant residues are returned to the soil during fallow years.
- Tillage raises soil temperatures and increases aeration and mixing of the soil, which increases the rate of decomposition of soil organic matter and crop residues compared to a soil with a growing crop. Declining soil organic matter content degrades the physical structure or tilth of the soil. Poorer soil structure results in less infiltration of precipitation into the soil resulting in increased runoff, further increasing the likelihood of soil and nutrient losses.
- Lack of plant residues on the surface as a result of repeated tillage operations leave the soil vulnerable to water (and wind) erosion.
- All fallow systems increase the risk of nutrients being lost from the soil through volatilization and leaching.
- Loss of crop available nutrients. As organic matter and crop residues decompose, soil microorganisms mineralize organic forms of crop nutrients to crop-available forms. Normally, these mineralized nutrients would be taken up by growing crops but in fallowed fields they remain in the soil and may be lost either through leaching or gaseous emissions.
- Impact on groundwater recharge. Crop plants are large consumers of soil moisture and play an important role in regulating soil moisture conditions. Under fallow conditions, more precipitation percolates down through the subsoil and enters the groundwater. This can transport water-soluble crop nutrients (e.g., nitrate) to groundwater sources and impact groundwater quality. Downward movement of water can also move salts to groundwater discharge areas causing groundwater levels to rise in these discharge areas and potentially increase salinity.

Conservation Fallow

Conservation fallow maintains plant residues on the soil surface, which helps to reduce soil erosion while still providing weed control and soil moisture conservation benefits. With no tillage, stubble and other residues from the preceding crop are left undisturbed, erect and anchored, as are the remains of the dead weeds. This practice protects the soil from wind and water erosion and increases snow catching. The shade provided by the residues keeps the soil surface cooler and together with less tillage-induced aeration of the soil reduces evaporation.

At the end of summer fallow period, typically 60 to 80% of the protecting stubble remains. Losses during this period are due to the normal decomposition from ultra-violet radiation, chemical oxidation and microbial activity.

Winter Cereal Production or Cover Crops

Another strategy for maintaining ground cover during periods of high runoff risk from snowmelt is to include winter cereals in crop rotations or selectively planted in vulnerable areas. Winter cereals begin growing and using nutrients in the fall reducing the opportunity for the loss of applied nutrients (i.e., manure or fertilizer) later in the season. Even though winter cereals do not grow much during the winter, the crop prevents free flow of snowmelt water in the spring and the roots anchor soil particles. This reduces the risk of erosion and sediment-bound nutrient losses in the spring. Later in the season, winter cereals provide ground cover that buffers raindrop impact during rainfall events helping to preserve soil structure and reduce the risk of soil erosion.

Fall rye has the best winter hardiness and produces the most soil cover followed by winter triticale and then

more info



AF has over 30 publications relating to direct seeding and reducing tillage, including:

- 1996. Soil quality and moisture conservation benefits of direct seeding. **Agdex 570-6.**
- 1999. Direct seeding systems: terms, definitions and explanations. **Agdex 570-7.**
- 2006. Making the move to direct seeding. **Agdex 570-5.**

Another excellent resource is Reduced Tillage LINKAGES (www.reducedtillage.ca), which has a network of specialists throughout Alberta that can provide advice on issues relating to reduced tillage production systems.

The Prairie Farm Rehabilitation Administration (PFRA) with AAFC also has information relating to reduced tillage in the following online documents:

- Brandt, S. 2006. Tillage practices that reduce soil erosion. www.agr.gc.ca/pfra/soil/tillage_e.htm
- PFRA. 2006. Economics of zero till. www.agr.gc.ca/pfra/soil/swork1.htm

more info



For more information on the benefits of conservation fallow

is available in the following online document, accessible through Ropin' the Web.

- AF. 1993. Summer fallow and soil conservation. **Agdex 570-3.**

The PFRA with AAFC also has information relating to the economics of conservation fallow in the following online document:

- PFRA. 2006. Economics of conservation fallow. www.agr.gc.ca/pfra/soil/swork3.htm



winter wheat. Winter cereals for water erosion control should be planted as early as possible to maximize growth and soil cover before the dormant period. They can then be terminated in spring with herbicide and planted to spring crops or left and harvested as a winter crop. Spring cereals planted in late summer or early fall will also provide good winter cover and may substitute for winter cereals in some situations.

Green Manures

Green manuring is the practice of growing and terminating a short-term crop, which can include cereals, oilseeds and legumes, part way through the growing season. A green manure crop is grown to provide short-term ground cover during the growing season reducing the risk of erosion and runoff.

Traditionally, green manuring was used prior to the availability of nitrogen fertilizers to boost soil fertility. Legumes such as peas, lentils, or clovers, which “fix” atmospheric nitrogen are the preferred options for manuring because the residues from these crops have a high concentration of nitrogen that is readily released for subsequent crops.

The traditional practice is to bury crop biomass, which returns most of the fixed nitrogen and plant material to the soil. To provide protection from surface erosion, however, some crop residue must be left on the soil surface. This can be accomplished by either desiccating the crop using herbicides or by haying the crop.

Perennial Forages in Crop Rotations

Including perennial forages in long-term crop rotations is perhaps one of the most effective ways to minimize soil and nutrient losses from runoff. Perennial forages can be grown on poorer soils or on sites where slope is a serious constraint. This allows these areas to remain productive while minimizing erosion.

They provide dense ground cover, which protects the soil from erosion through buffering against raindrop impact filtering soil from runoff and slowing the speed of runoff thereby altering its erosive potential. In addition, the fibrous roots hold the soil in place.

Forages improve soil structure improving the ability for water to infiltrate into the soil and reduce runoff and erosion. Soil structure is improved through contributions to the soil organic matter pool as well as through the root structure of forages which tends to be finer than annual crops and creates a large number of small channels in the soil.

Conservation crop rotations designed to address erosion concerns typically alternate forages with cereals and oilseeds or legumes. Including legumes in the rotation will also boost soil nitrogen levels and improve soil fertility. Legumes can return about 60% of the plant material and nitrogen to the field. Perennial forage crops that are hayed can be added to the crop rotation to mine surplus nutrients such as phosphorus and potassium reducing the risk associated with nutrient build-up in the soil.

Forages can be successfully established by direct seeding. Forage stands can be terminated using herbicides and then an annual crop can be direct seeded into the field minimizing the exposure or bare ground and reducing the negative affects of tillage operations of increasing the risk of erosion and nutrient loss.

Retaining Crop Residues

Crop residues include straw, chaff and roots. Crop type and yield influence the amount of crop residue produced (Table 8.2.3). Leaving or returning crop residue to the land can help reduce runoff related soil and nutrient loss.

Table 8.2.3 Typical Amounts of Straw and Chaff Produced per Bushel of Grain

Crop	Soil Zone	Pounds of Straw Per Bushel of Grain*	Pounds of Chaff Per Bushel of Grain**
HRS Wheat	Brown	50	20-25
	Dark Brown	65	
	Black, Gray	80	
CPS Wheat	Brown	40	20-25
	Dark Brown	50	
	Black, Gray	60	
Barley	Brown	30	5-10
	Dark Brown	35	
	Black, Gray	45	
Oats	Brown	30	5-10
	Dark Brown	35	
	Black, Gray	45	
Canola	Brown	40	15-20
	Dark Brown	50	
	Black, Gray	60	
Peas	Brown	40	20-25
	Dark Brown	50	
	Black, Gray	60	

* Amount of harvestable straw, assuming about 80% recovery in cereals, and 50% in peas and canola, with 5 to 10 cm (2 to 4 inch) stubble left.

** Amount of harvestable chaff, assuming little or no weed chaff.

Adapted from: Hartman, M. 1999. Estimating the Value of Crop Residues. AF, Agdex 519-25

Standing stubble increases snow catch and has more benefit than loose, surface residue for wind erosion control. Surface residue that is well anchored with some standing stubble is also very effective for water erosion control, maintenance of good soil structure, increasing infiltration rates and preventing soil drying. Retaining straw and chaff on the surface of a field offers many benefits including increased snow catch, infiltration, reduced evaporation, increased soil organic matter, improved soil structure and plant nutrient cycling, reduced erosion risk and reduction of some weed species.

more info



AF has several publications relating to winter cereal

production, including:

- AF. 1998. Direct seeded winter wheat. **Agdex 112/22-1.**
- AF. 1999. Winter wheat in the Parkland area of Alberta. **Agdex 112/11-1.**
- AF. 2001. Winter cereals for pasture. **Agdex 133/20-1.**

These can be ordered from the **Publications Office** (1-800-292-5697) or viewed on **Ropin' the Web**.

Another resource is the online winter cereal production manual maintained by the University of Saskatchewan at: www.usask.ca/agriculture/plantsci/winter_cereals/index.php

Ducks Unlimited also has some information available on winter cereal production available at www.wintercereals.ca.



Practices that Reduce Soil Compaction

As was discussed in the previous chapter, soil structure influences infiltration of water into the soil and the extent and severity of runoff. Traffic from heavy field equipment, especially when soils are moist, compresses the soil structure compacting and sealing the soil surface and preventing water infiltration. Water from precipitation then has a greater tendency to accumulate on the soil surface setting the stage for runoff events resulting in soil and nutrient loss.



Tips for Preventing Soil Compaction

- Avoid wheel traffic on soils that are too wet
- Use wide, dual tires or tracks
- Maintain minimal tractor tire inflation pressure for an acceptable tire lifespan
- Avoid heavy, oversized equipment that exceeds job requirements
- Combine or eliminate field operations to minimize number of passes on the field
- Minimize tillage on soils in the spring
- Keep openers and shovels sharp
- Adopt practices that build soil organic matter and improve structure
- Vary the depth of primary tillage operations from year to year
- Use track-type tractors or tractors with four-wheel drive or mechanical front-wheel drive instead of two-wheel drive
- Vary directions of field operations

Additional Resources

More information on green manuring is available in the following document from **Ropin' the Web**:

- AF. 1993. Legume green manuring. Agdex 123/20-2.

Other valuable online resources with information on green manure include:

- McGill University. Not Dated. The basics of green manuring. EAP Publication 51. <http://eap.mcgill.ca/Publications/EAP51.htm>
- National Sustainable Agriculture Information Service. 2003. Overview of cover crops and green manures. <http://attra.ncat.org/attra-pub/covercrop.html>
- Sustainable Agriculture Network. 1998. Managing cover crops profitably. 214 pg. www.sare.org/publications/covercrops/covercrops.pdf
- University of California (Davis). 2006. Cover crop database. Sustainable Agriculture Research and Education Program. www.sarep.ucdavis.edu/ccrop/search_ccrop.html

AF has several publications relating to forage production, including:

- 2005. Perennial forage establishment in Alberta. 120/22-3.
- 2006. Varieties of perennial hay and pasture crops for Alberta. Agdex 120/32.
- 2006. Applying manure on perennial forage. Agdex 538/120-2.
- 1999. Removing forages from the rotation in a direct seeding system. Agdex 519-17.
- 1999. Residue management for successful direct seeding. Agdex 570-4.

- 1999. Estimating the value of crop residues. Agdex 519-25.
- 1999. Handling difficult crop residue conditions in direct seeding systems. Agdex 519-2.

The Alberta Forage Manual (Agdex 120/20-4) is available from the Publications Office for a price of \$10.00.

These publications and others can be ordered from the Publications Office (toll free in Canada 1-800-292-5697), or can be downloaded from the publications page on www.ropintheweb.com.

PFRA with AAFC also has information relating to crop residue management in the following online document:

- PFRA. 2006. Managing crop residues on the prairies. www.agr.gc.ca/pfra/land/residue_e.htm

More information on soil compaction is available in the following online documents:

- DeJong-Hughes, J., Moncrief, J. F., Voorhees, W. B. and Swan, J. B. 2001. Soil compaction: causes, effects and controls. University of Minnesota Extension Service. www.extension.umn.edu/distribution/cropsystems/DC3115.html
- Manitoba Agriculture, Food and Rural Initiatives. Soil management guide: soil compaction. www.gov.mb.ca/agriculture/soilwater/soil/fbe01s10.html
- Petersen, M., Ayers, P. and Westfall D. 2006. Managing soil compaction. Colorado State University Cooperative Extension Service. www.ext.colostate.edu/PUBS/crops/00519.html
- Kok, H., Taylor, R.K., Lamond, R.E. and Kessen, S. 1996. Soil compaction: problems and solutions. Kansas State University Cooperative Extension Service. www.oznet.ksu.edu/library/CRPSL2/AF115.pdf



→ summary

- Manure spread on snow-covered or frozen ground is in direct contact with snowmelt runoff water, increasing the risk of nutrient transport.
- Applying fertilizer and manure at rates that meet crop nutrient requirements will reduce the risk of nutrient build-up in the soil and potential for transport.
- Apply manure just prior to seeding and active crop growth, so that plants take up nutrients and reduce the opportunity for nutrient loss.
- The incorporation of manure can reduce its exposure to surface runoff events.
- **Conducting field operations across the slope (on the contour) produces micro channels that intercept and slow the flow of runoff down the slope.**
- Permanent cover can be grown on sloped land to help hold the soil in place and **promote water infiltration, reducing soil and nutrient losses.**
- Conservation tillage and conservation fallow systems increase the amount of crop residue left on the surface soil surface, minimizing erosion risk and conserving soil moisture.
- Winter cereals use nutrients in the fall, their roots anchor soil particles, provide ground cover and reduce the opportunity for erosion nutrient losses.
- A green manure crop is grown to provide short-term ground cover during the growing season, reducing the risk of erosion and runoff.
- **Minimizing traffic from heavy field equipment can prevent the compaction of soils and maintain water infiltration, reducing the risk of erosion losses.**

Chapter 8.3

Constructed Erosion Control Measures to Reduce Nutrient Losses In Runoff

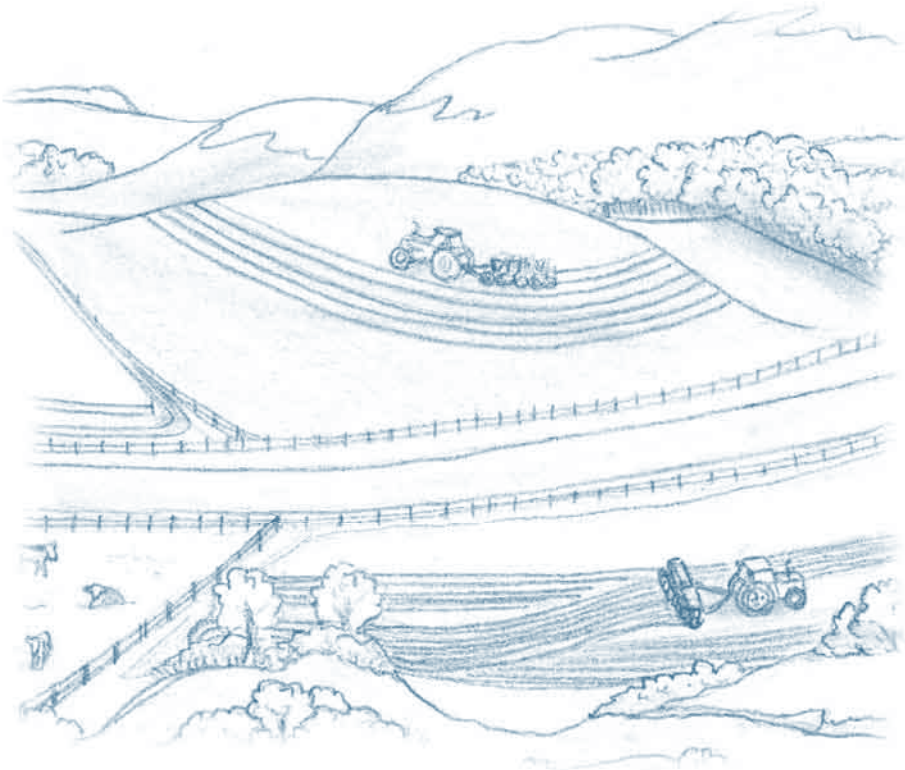

→ learning objectives

- List four constructed erosion control measures and briefly explain how each reduces the risk of erosion and nutrient losses due to runoff.



Important Terms

Table 8.3.1 Key Terms and Definitions

Term	Definition
Basin	Earthen structure used to store water as it runs off or is generated from upstream land or facilities. While this water is being held or ponded, solids and some contaminants can be settled out of the water column.
Berm	Generally refers to a low earthen mound above natural ground level. They are used to control erosion and sedimentation by reducing the rate of surface runoff.
Diversion Channel or Interception Ditch	Earthen channels that are constructed below the existing surface to contain water within its banks. Used to divert and/or control water coming onto croppled land and stop water erosion from causing nutrient loss from the soil.
Drop Structures	These structures are often characterized as a vertical drop of several feet onto a horizontal stilling basin to dissipate the energy of flowing water and allow relatively low velocities (nonerosive) to exit the drop structure area. Many types exist such as drop inlet pipe, sloped pipe, chute spillways, grade controls and lined waterways.
Geotextiles	These are permeable, durable fabrics which, when used in association with soil, have the ability to separate, filter, or drain liquid and reinforce or protect soil. Filter cloth is commonly used term for a widely used fabric to keep fine soil particles from washing out from below higher cost materials or structures.
Grassed Waterways	Broad, shallow, saucer-shaped channels, which are grassed and designed to move surface water across farmland without causing soil erosion.
Gullies	A small valley or ravine worn away by running water and serving as a drainage-way after prolonged heavy rains.
Ponding	Water that collects in small depressions, into a pond or large puddle.
Run-on	Surface water originating upslope of a particular parcel of land. This water may be from natural runoff from upslope land parcels, natural areas or controlled releases from facilities.
Sheet Flow or Sheet Runoff	Runoff that flows uniformly across the landscape and not in concentrated channels or gullies.
Vegetative Field Borders (VFB)	Areas of natural or managed vegetation located at the edge of a croppled field to retain and buffer the passage of nutrients onto another land parcel, watercourse or water body.
Water Bodies	Bodies of surface water, including lakes, streams, rivers, wetlands and sloughs.

This chapter looks at more intensive control measures to deal with runoff from snowmelt or rainfall on fields with long, continuous slopes with a greater than 6 % grade. This chapter focuses on constructed erosion control measures to supplement in-field management practices to reduce erosion and nutrient losses in runoff.

The control measures discussed in this chapter are often more expensive and require more planning than the practices described in the previous chapter. Services from a professional engineer may be needed. Also, in contrast to the management practices in the last chapter, their placement on croppled land may reduce the net productive area. Despite these drawbacks, these measures can dramatically reduce the amount of soil and nutrients loss from high-risk areas for many years and even decades if they are properly designed and maintained.

Combining several constructed erosion controls with the practices discussed in the previous chapter is most effective for reducing slope-related runoff nutrient losses.

Note that much of the information available on constructed erosion control measures is based on experience in warmer areas of the United States with high annual precipitation where the majority of runoff is a result of rainfall. Although most runoff is from spring snowmelt, in Alberta some intense rainfall early in the growing season has caused the most erosive runoff events. Because of these differences in types of runoff, not all measures used in the warmer areas are applicable to Alberta. If control measures are applicable, tips are included to successfully implement these controls under Alberta conditions where possible.

Grassed Waterways

Grassed waterways are broad, shallow, saucer-shaped channels designed to move surface water across farmland without causing soil erosion. There are three features of this control measure:

- The key component of this control is the vegetative cover in the waterway, which slows the speed of water flow in the watercourse and serves as a physical filter that removes sediment (and sediment bound nutrients) from water flow. As long as sediment deposition is not excessive, the sediment-bound nutrients trapped by the vegetative cover can then be used to supply the nutrient requirements of waterway vegetation.
- Waterways are typically constructed along the natural surface drainage pattern in a field. In many cases these are built to rehabilitate gullies formed as a result of the erosive force of surface runoff events.
- Ideally, the waterway conducts water to a suitable outlet, typically a ditch, water body or other control structure such as a settling basin.

Advantages of Grassed Waterways

- Earthwork during construction is minimized and potential licensing requirements are reduced when existing field drainage patterns are followed.
- If designed properly, they can be safely crossed by farm machinery.
- Grassed waterways are capable of handling large flows, which makes them suitable for handling larger drainage areas.
- Once vegetation in the waterway is firmly established, maintenance requirements are minimal.
- Provided the waterway is properly maintained, waterway vegetation can serve as a valuable source of forage for livestock.

As a guideline, use grassed waterways when working with a drainage pathway handling runoff from area greater than 20 ha (50 ac). Grassed waterways are most effective on sites where runoff flow tends to concentrate in identifiable channels, which in some cases may erode to form gullies. Use other controls such as zero till for smaller areas.

If properly sized and constructed, grassed waterways will safely transport water down slopes. This characteristic makes them suitable for use as an outlet for contour cropping operations and as run-on diversion channels. Once the velocity of water running down a grassed channel exceeds about 1.2 metres per second (4 ft/s), the grass channel lining may need to be reinforced or alternative methods such as drop structures to reduce the channel grade should be investigated.

more info



The Association of Professional Engineers, Geologists and Geophysicists of Alberta (APEGGA) regulates the practice of engineering, geology and geophysics in our province under a mandate in the provincial *Engineering, Geological and Geophysical Professions Act*.

The association website (www.apegga.org) has some useful advice on how to **find a consultant or contact APEGGA with questions:**

Phone: Toll free (in North America) 1-800-661-7020

Email: email@apegga.org



tip



Appropriate authoritative agencies such as Alberta Environment should be contacted in regards to any licensing requirements for the outlet of Grassed Waterways or diversions. Phone (780) 427-2700.



Design and Installation Recommendations

Use the following design and installation recommendations to maximize effectiveness and ease of maintenance of grassed waterways. The services of a professional engineer may be required depending on complexity and impact of adjacent landowners or infrastructure.

- Design and construct waterway to handle the required flow of water. The flow of water is influenced by amount and timing of snowmelt or precipitation, site topography, watershed area, soil conditions and crop type. Water flow is also influenced by management practices in the field (e.g., direct seeding and reduced tillage compared to conventional tillage). Ensure that the initial bare-soil condition and the more stable grass-covered condition are considered in the design relative to the potential risk of extreme rainfall events during establishment.
- The degree of erosion control provided by the waterway is related to the density of plant cover in the waterway. Therefore, timing of construction is important. Complete construction and seeding of the waterway in spring to ensure sufficient plant growth before snowmelt runoff the following spring. Construction should begin at the outlet and proceed upstream in the event of a rainfall runoff event during construction.
- Design waterways to be saucer-shaped (Figure 8.3.1). This shape spreads the flow of water over a greater surface area slowing its velocity and reducing its erosive force. This design also makes it easier to cross the channel with machinery and mow or harvest the vegetation. Use a standard width of the bottom of the waterway of 3 m (10 ft). The bottom portion of the channel should not be constructed horizontally but rather tilted slightly to one side so rills do not form in the bottom of the channel during lower flows before grass is established.

- Design waterways in conjunction with other limiting structures. Sometimes routing waterways through existing or newly placed culverts or other control structures is necessary. Care needs to be taken in the hydraulic design of these structures and also the entrance and exit of the waterways to prevent destruction of the structure.
- If the slope is very steep other erosion control structures and materials can be implemented. Some examples are filter cloth, geotextiles, and various drop structures to dissipate some of the energy of the water.

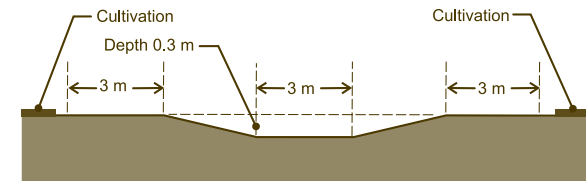

Figure 8.3.1 Cross Section of a Typical Constructed Grassed Waterway

- The side-slopes of the waterway should be 10:1 but no steeper than 4:1. A slope of 4:1 means 4 horizontal feet to one vertical foot. This ensures that the waterway functions properly but can still be crossed with equipment safely.
- Remove brush, rocks and other debris from the work area before construction. If these obstructions are not removed or buried, water will erode more quickly around them causing gullies or ponding to form. Any fill that is used in the channel should be packed hard.
- Remove topsoil from the working area, stockpile and replace after construction. Allow extra depth of the waterway to accommodate return of topsoil after construction. After spreading, level and harrow the topsoil to provide a smooth bottom and a good seedbed. Spread excess soil away from the sides, so runoff from adjoining land can flow easily into the waterway.

- Seed across the waterway (Figure 8.3.2). In the same way that farming the contour of a slope reduces erosion, seeding perpendicular to the direction of the water flow helps increase friction and further slow the flow of water in the waterway.

Step 1: Seed along the outer edges, leaving the center one-third unseeded.



Step 2: Seed the center by gently steering from side to side to make one-half of a figure-eight.

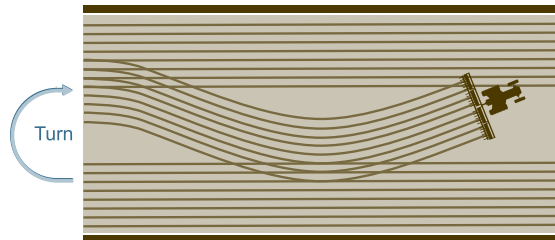

Step 3: On the return trip, seed the remaining areas and make the other half of the figure-eight.

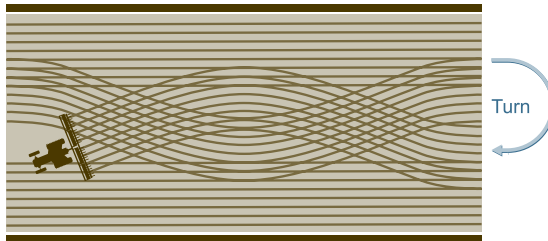

- When establishing the waterway, use forage mixes that establish quickly and contain sod-forming, long lived grass species. To be effective, the waterway must have well-established vegetation capable of withstanding the force exerted by the flow of water through the waterway and prolonged submersion under water. Use a hardy cover crop such as fall rye to protect the waterway until grass becomes established. Since fertility can be an issue in newly constructed waterways, apply inorganic fertilizer to help the plants gain a foothold.



more info



For more information on the design, installation and maintenance of grassed waterways can be found in the following online resources:

- AAFC – PFRA. 1989. Manitoba Soil Conservation Resource Manual - Water Erosion. www.agr.gc.ca/pfra/soil/soilc02a.htm
- Ontario Ministry of Agriculture, Food and Rural Affairs. 1994. Grassed Waterways. Agdex 751. www.omafra.gov.on.ca/english/engineer/facts/94-039.htm
- AF. 2002. Grassed Waterway Construction. Agdex 573-6.

Figure 8.3.2 Recommended Seeding Pattern for Grassed Waterways

more info



For more information on the design, installation and maintenance of earthen berms can be found in the following online resources:

- Ontario Ministry of Agriculture, Food and Rural Affairs. 1990. Use of Earthen Berms for Erosion Control. Agdex 751. www.omafra.gov.on.ca/english/engineer/facts/99-047.htm

tip



VFBs are an “edge-of-field” beneficial management practice.

Use them in combination with crop and field management practices that minimize soil and nutrient losses in runoff. The VFB on their own have limited ability to reduce the amount of nutrient lost from a field, particularly from large, sloping sites. They are much more effective if used with direct seeding, reduced tillage and conservation fallow.



Figure 8.3.3 Constructing Grassed Waterways.

Run-on Diversion Channels or Basins

In certain situations it may be possible to divert or control water coming onto cropped land and stop water erosion from causing nutrient loss from the soil. This water may be from natural runoff from upslope land parcels or natural areas or controlled releases from intensive livestock operations.

Diversion Channels or Berms

Earthen channels are constructed below the existing surface to contain water within its banks whereas berms are built above grade and pond or divert water back onto cropped land upslope.

Constructing a run-on diversion channel (or interception ditch) may be most suitable when an alternative waterway, natural or manmade, has adequate safe capacity a short distance away with minimal elevation rise between them. Because a change to natural flow patterns is caused, careful planning and approval is required ahead of construction.

Terracing is a coupling of a channel and a berm and provides a similar result as run-on diversion channels but it is integrated on to the cropped land. Terracing breaks up the length of a slope. Multiple diversion channels or berms are formed at intervals perpendicular to the dominant field slope (following contours) and divert water to a safer, less erodible outlet. Terracing is common in some parts of the world especially where they can be constructed by hand on smaller farms. These have been tried in Alberta with mixed results but are not commonly constructed or seen.

Basins

Basins can store water as it runs off or is generated from upstream land or facilities. While this water is being held or ponded, solids and some contaminants can be settled out of the water column. Water with less sediment in it is less erosive. Examples of basins on agricultural landscapes include feedlot catch basins, exercise yard runoff basins, sediment control basins, and irrigation return flow catchments. Basins are most effective when they are regularly emptied so as to have the maximum volume available for runoff retention with less earthwork construction. Water held temporarily in basins can be emptied in a number of ways including:

- Release it to downstream channel at a lower flow rate or at a better time when less erosion is likely to occur.
- Spray irrigate it over a larger land area at rates not to cause runoff or erosion

Vegetative Field Borders

Vegetative field borders (VFB) are areas of natural or managed vegetation situated between a non-point source of pollution, such as a field that has received manure or fertilizer, and an environmentally sensitive area, most often a water body.

Properly designed VFBs provide protection to surface water quality by removing sediment, organic matter, some nutrients and pesticides from runoff at the edge of the field before it enters the surface water bodies.

Other Benefits of VFBs:

- They provide a habitat for wildlife.
- They provide a source of forage or hay for livestock.
- They become an area to turn equipment around at the end of field rows.

VFBs are most effective on sites with slight to moderate slopes where the runoff pattern from the field tends to be uniformly spread rather than concentrated in channels (i.e., sites prone to sheet erosion).

VFBs reduce nutrient export from fields that have received manure or fertilizer application through two main mechanisms:

- **Physical filtering.** Any sediment-bound nutrients are trapped in the strip rather than being carried into the adjacent water body. Larger-sized soil particles (i.e., sand and silt) and soil aggregates settle from the runoff within a relatively short distance into the filter. Fine particles such as clay may take a longer distance to settle out and, depending on runoff conditions, may not be deposited in the strip to any large extent. This filtering action would have little impact on reducing soluble nutrient concentrations in runoff.
- **Infiltration.** The velocity may be slowed to the point that water is allowed to penetrate into the soil allowing dissolved nutrients to be used by vegetation in the strip. With time this will result in the accumulation of nutrients within the VFB. For the VFB to function properly it must be regularly harvested to remove plant growth and accumulated nutrients. This mechanism does not work well in areas where soil conditions (i.e., compacted or frozen) during runoff impede infiltration.

Periodic monitoring of the nutrient status of the soil is required to prevent the VFB from becoming overloaded and turning into a nutrient source.

Establishing VFBs

When planning installation of a VFB, consider several site-specific characteristics:

- soil properties
- steepness of the slope
- expected quantity and timing of runoff
- shape and area of the field draining into the filter
- management practices in use on the field that drains through the VFB.

The most important factors influencing the effectiveness of a VFB are:

- The width of the VFB depends on its desired function and adjacent spaces. The width of a VFB to stabilize field edges that border steep ditches or steep banks will be smaller than the width necessary to effectively capture nutrients in runoff.
- For the VFB to filter runoff efficiently, runoff must pass through the strip in a shallow, uniform flow (i.e., sheet flow). This means they must be situated where runoff can be filtered before it concentrates in natural or manmade drainage channels which are influenced by the topography within the field.
- VFBs should be seeded perpendicular to the slope to create conditions that allow for shallow, uniform flow to enter the filter.
- Select suitable vegetation to ensure long-term effectiveness of the VFB. Suitable plants should have a dense top-growth, a fibrous root system, provide good, uniform soil cover and be suited to local soil and climatic conditions.
- If border vegetation is to be used for forage production, consider agronomic factors such as yield, feed quality and herbicide compatibility.

sidebar

Heavy use of VFBs as field roadways should be avoided due to the risk of compaction and resulting loss of effectiveness as a filter.



sidebar

Other terms used interchangeably with VFB include grass barriers, riparian buffer strips and conservation buffers. This guide uses the term VFB to refer to all of these structures since they all perform the same basic function.

more info



For more information on the design, installation and maintenance of VFSs can be found in the following online resources:

- **AF. 2003. Buffer Zones for a Healthy Watershed:** [www1.agric.gov.ab.ca/\\$department/deptdocs.nsf/all/irr6419](http://www1.agric.gov.ab.ca/$department/deptdocs.nsf/all/irr6419)
- **Ohio State University Extension. The Economics of Vegetative Filter Strips** <http://ohioline.osu.edu/ae-fact/0006.html>



VFBs on Steep Slopes

Runoff from slopes greater than 10 % would overwhelm the capacity of the VFB to remove sediment and contaminants from runoff. Since most major runoff events in Alberta occur during a relatively short period during spring thaw, consider alternative control strategies for sites with steep slopes.

Among vegetation types, grasses are more effective than broadleaf plants in reducing erosion and filtering nutrients since they form a dense sod, have a fibrous root system and provide more extensive ground cover. Sod forming grass species are preferred to bunchgrasses since they form a more consistent ground cover reducing the likelihood of channelling through the VFB, thereby reducing its effectiveness. Legumes such as alfalfa or clovers may be seeded in a mixture with grasses in order to improve fertility of the stand. However, legumes can reduce the capacity to filter sediment, and as such should not be used as the dominant species in a VFB.

Trees and shrubs require additional maintenance but are superior for stabilizing streambanks, reducing flood risk and maintaining groundwater quality. Select tree and shrub species suitable for site conditions, to minimize problems with establishing and maintaining the VFB.

Maintain Natural Wetlands and Sloughs

Water bodies such as wetlands and sloughs provide a place for runoff waters to pond temporarily or completely depending on their size and the area draining to them. Unlike previous measures discussed in this chapter, they may require no additional investment other than their maintenance and protection.

Advantages of Natural Wetlands and Sloughs

- Slow the movement of water through a landscape or watershed reducing the erosion or destruction that can result.
- Provide an interface between surface water, groundwater and the air where shallow groundwater supplies can be recharged or evaporation can generate new rainfall.
- Improved water quality downstream due to the filtering and biological processes that are part of this aquatic environment.
- Provide a habitat for local wildlife.

While land area unavailable for cropping or lost crop production to wildlife may be viewed as disadvantages, the advantages are growing. Those listed above plus potential social and stewardship incentives to maintaining natural wetlands and sloughs are becoming more apparent.

Keeping in place natural waterways leading in or out of wetlands and sloughs may be all that is required to maintain this productive aquatic environment. Conservation farming practices such as zero till can reduce sediment deposit in these water bodies. Sediment deposits can shorten the effective lifespan of these water bodies, reduce their volume holding capacity and cause them to spread further onto productive crop land during major runoff events. Remote livestock watering devices, fencing, or use of alternative pastures for livestock production can reduce damage to key flow components in sloughs or wetlands. Vigilance in reporting unauthorized upstream water diversions or pumping may also keep this water body intact.

→ summary

- Grassed waterways reduce erosion and nutrient loss by physically holding the soil together and removing suspended sediment **through infiltration and filtering from runoff on sites where flow is concentrated in channels.**
- **VFBs are edge-of-field plantings of sod-forming species that can remove some sediment through infiltration and filtering from runoff on sites where flow is less concentrated and more uniform.**
- Diversion channels or berms may be used to divert or control water coming onto croppd land and stop water erosion from causing nutrient loss from the soil. Basins can be used to store water as it runs off or is generated from upstream land or facilities reducing the risk of erosion and the transfer of nutrients from the soil.
- Terracing is a coupling of a channel and a berm. Terracing breaks up the length of a slope and diverts water to a safer, less erodible outlet reducing the risk of erosion and the transfer of nutrients from the soil. This control structure is not typically used on cropland in Alberta.
- Maintaining natural wetlands and sloughs in an agricultural landscape can reduce the damage of major runoff events by collecting and slowing water runoff.
- Remember to follow up on any approval or licensing requirements for the projects you undertake.

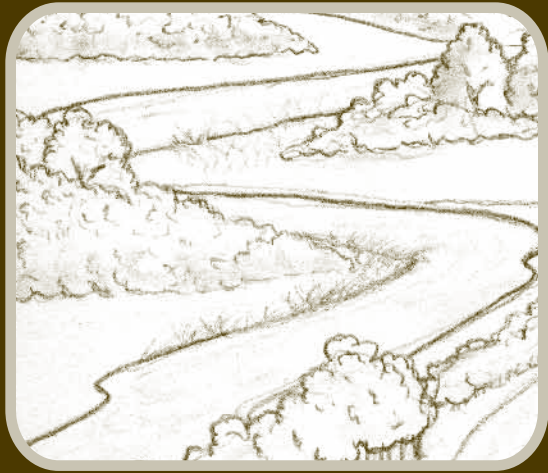

Appendices

Appendix 3A

Acreage Grid Map for Aerial Photo Interpretation

Appendix 3B

Products Available from the Air Photo Distribution Office

Appendix 3C

List of Laboratories Offering Soil and Manure Analysis Services

Appendix 3D

How to Use a Slope Gauge

Appendix 4A

Standard Values for Manure Nutrient Content and Estimated Daily Manure Production

Appendix 6A

Crop Nutrient Uptake and Removal Coefficients

Appendix 6B

Calculating Expected Nutrient Uptake and Removal

Appendix 3A

Acreege Grid for Map and Aerial Photo Interpretation

» How to use this grid

1. Photocopy this grid onto a transparency sheet.
2. Place grid over the area to be measured.
3. Use a non-permanent, find tipped overhead pen and trace the area of interest.
4. Count the number of dots within the outlined area (**Note:** when dots fall on the area boundary, count every other dot).
5. Use the tables on the next page to estimate area.

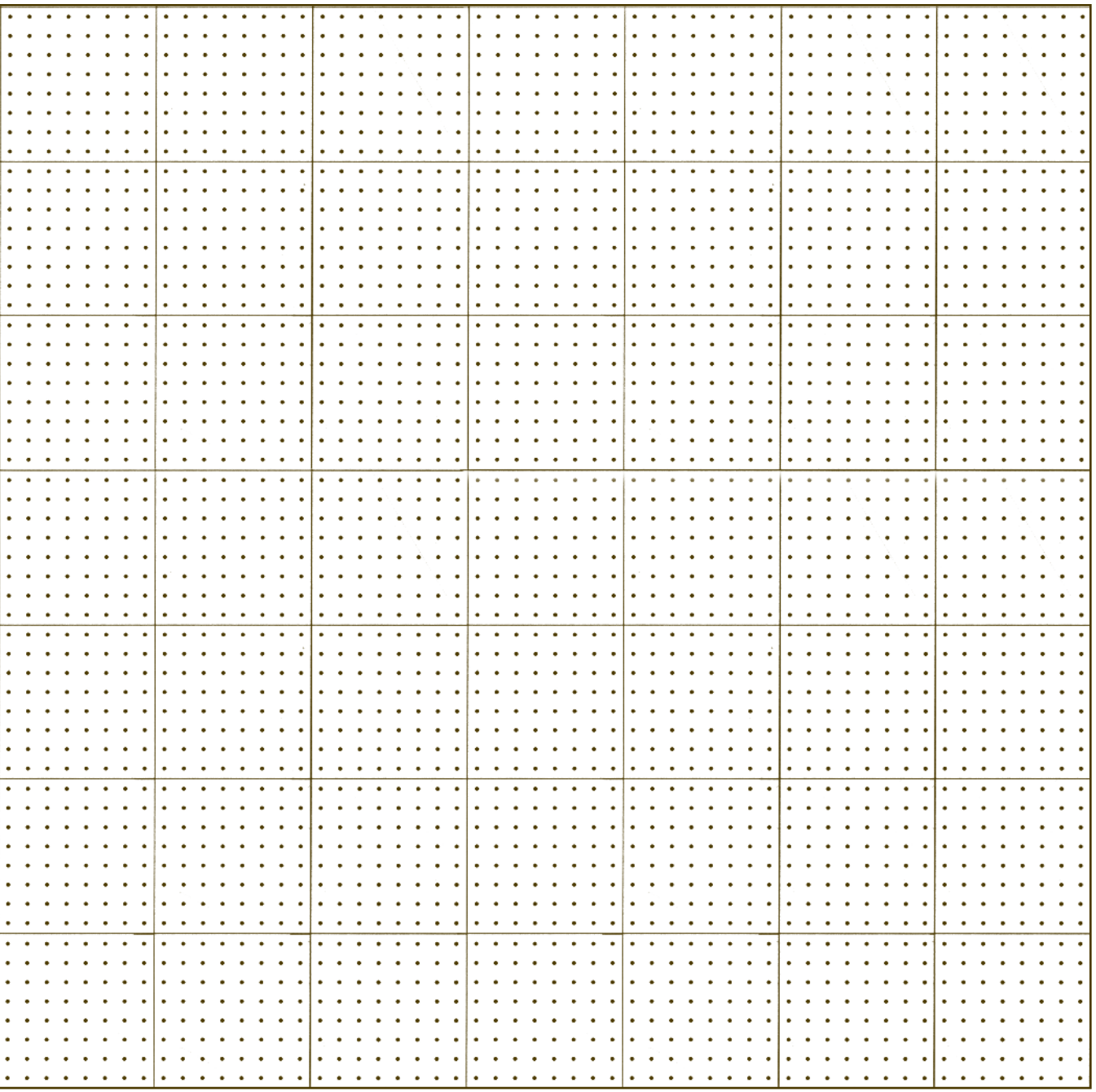

Common map scales plus approximate metric measurements and estimates of area

Relative Scale	Scale in Centimetre and Metres	Centimetres per Kilometer	Hectares per Map Square (2.5 x 2.5 cm)	Representative Hectares for Each Dot in the Square
1:5,000	1 cm = 50 m	20.000	1.613	0.025
1:10,000	1 cm = 100 m	10.000	6.452	0.101
1:15,000	1 cm = 150 m	6.667	14.517	0.227
1:20,000	1 cm = 200 m	5.000	25.807	0.403
1:30,000	1 cm = 300 m	3.333	58.066	0.907
1:31,680	1 cm = 317 m	3.157	64.752	1.012
1:40,000	1 cm = 400 m	2.500	103.229	1.613
1:60,000	1 cm = 600 m	1.667	232.265	3.629
1:63,360	1 cm = 633.6 m	1.578	259.008	4.047

Common map scales plus approximate imperial measurements and estimates of area

Relative Scale	Scale in Inches and Feet	Inches per Mile	Acres per Map Square (1 x 1 in.)	Representative Acres for Each Dot in the Square
1:5,000	1 in = 417 ft	12.672	3.986	0.062
1:10,000	1 in = 833 ft	6.336	15.942	0.249
1:15,000	1 in = 1250 ft	4.224	35.870	0.560
1:20,000	1 in = 1667 ft	3.168	63.769	0.996
1:30,000	1 in = 2500 ft	2.112	143.480	2.242
1:31,680	1 in = 2640 ft	2.000	160.000	2.500
1:40,000	1 in = 3333 ft	1.584	255.076	3.986
1:60,000	1 in = 5000 ft	1.056	573.920	8.970
1:63,360	1 in = 5280 ft	1.000	640.000	10.000

Appendix 3B

Table 3B-1. Listing, Description and Prices (as of October 2006) for Products Available from the Air Photo Distribution Office¹

Product Name	Description	Price ²		Notes
		B&W	Colour	
Contact Prints	Contact prints are photographic copies made directly from the film negatives. The image size is approximately 25 cm (9.5 in.) square. The photographs are printed on matte photographic paper.	\$8.75 (Regular) \$17.50 (Rush)	\$12.00 (Regular) \$24.00 (Rush)	Pre 2004 False colour IR photography is no longer available as contact prints but available in digital and laser copy format.
Diapositives	Diapositives are copies of photographs printed on clear film rather than photographic paper.	\$11.00	\$11.00	Diapositive orders will be processed and ready for pick up at our Edmonton office within 10 business days.
Laser Prints	Laser prints would be appropriate for situations where photographic quality contact prints are not required. They are created from the existing contact prints within the Reference Library using a 600 dpi laser copier.	\$6.00	\$7.00	Laser prints are typically produced within five business days. Small quantities may be obtained as you wait; larger orders will take longer.
Digital Photography	High-resolution (default 800 ppi) aerial photos are in digital MrSID file format.	\$13.50 (800 ppi) \$16.50 (1200 ppi)	\$13.50 (800 ppi) \$16.50 (1200 ppi)	Digital format (MrSID = GIS image format) orders processed within 3-5 working days delivered free by ftp site or on CD for \$10.00. Higher ppi values and different file types are available upon request. <i>Note: MrSID file format is directly supported by the major GIS programs. Other free MrSID viewers are also available for download from the Air Photo Office ftp site.</i>
Laser Enlargements	Laser enlargements are derived from the original contact prints and are printed out at 600 lpi.	\$12.00	\$12.00	Laser enlargements (up to ×4) and up to 11×17-in. paper size can be done while you wait, but depends on the order size. The advantage of laser enlargements is that the turnaround time is quick and it is the lowest price enlargement.
Digital Enlargements	High-resolution digital enlargements are created from scanned prints/negatives and printed out at 2400 lpi.	\$20.00	\$20.00	The enlargement factor is limited only by the size of the area to be enlarged up to 11×17-in. paper size. Faster turnaround time than contact enlargements and better quality and higher enlargement factor than laser enlargements.
Photographic Enlargements	Photographic enlargements are available from aerial photographs and are made directly from the film negative.	\$28.00 – \$125.00 (Size-dependent)	\$28.00 – \$125.00 (Size-dependent)	An area of a photograph can be enlarged up to a paper size of 100 x 100 cm with the most common paper size being 25 x 25 cm and 50 x 50 cm. Orders processed within 10 working days.

Source: http://www.srd.gov.ab.ca/land/g_air_products.html

Prices are those quoted on the Air Photo Distribution Office website **effective June 2006** and are subject to change. To confirm prices for specific products and quantities, please contact Air Photo Distribution Office in Edmonton by phoning the Alberta Government toll free line 310-0000 and requesting (780) 427-3520.

Appendix 3C

List of Laboratories Offering Soil and Manure Analysis Services within Canada

Important note: This list is current as of July, 2007. Please contact individual companies to get more information regarding cost and the roster of services they provide. Contact information for these companies is provided for your information only and should not be interpreted as an endorsement or as a guarantee of quality service.

» [Bodycote Norwest Labs](http://www.bodycotetesting.com)
(www.bodycotetesting.com)

Edmonton

7217 Roper Road, Edmonton, AB T6B 3J4
Phone: (780) 438-5522 Fax: (780) 434-8586
Toll Free in western Canada: 1-800-661-7645
Email: Edmonton@bodycote.com

Calgary

#9, 2712-37 Avenue N.E., Calgary, AB T1Y 5L3
Phone: (403) 291-2022 Fax: (403) 291-2021
Toll Free in western Canada: 1-800-661-1645
Email: Calgary@bodycote.com

4605 – 12 Street, NE, Calgary, AB T2E 4R3
Phone: (403) 291-3024 Fax: (403) 250-2819
Toll Free in western Canada: 1-800-331-8266
Email: Calgary@bodycote.com

Grande Prairie

11301-96 Avenue, Grande Prairie, AB T8V 5M3
Phone: (780) 532-8709 Fax: (780) 539-061
Email: GrandePrairie@bodycote.com

» [ALS Laboratories](http://www.alsglobal.com/Environmental/Labs/Overview.aspx)
(www.alsglobal.com/Environmental/Labs/Overview.aspx)

Edmonton

9936 - 67th Avenue, Edmonton, AB T6E 0P5
Phone: (780) 413-5227 Fax: (780) 437-2311
Toll-Free: 1-800-668-9878
Email: Edmonton@alsenviro.com

Calgary

Bay 7, 1313 - 44th Avenue NE, Calgary, AB T2E 6L5
Phone: (403) 291-9897 Fax: (403) 291-0298
Toll Free: 1-800-668-9878
Email: Calgary@alsenviro.com

Grande Prairie

9505-111 Street Grand Prairie, AB T8V 5W1
Phone: (780) 539-5196 Fax: (780) 513-2191
Email: GrandePrairie@alsenviro.com

Fort McMurray

Bay 1, 245 MacDonald Cr, Fort McMurray, AB T9H 4B5
Phone: (780) 791-1524 Fax: (780) 791-1586
Toll Free: 1-800-668-9878
Email: FortMcMurray@alsenviro.com

Saskatoon

819 58 Street East, Saskatoon, SK S7K 6X5
Phone: (306) 668-8370 Fax: (306) 668-8383
Toll Free: 1-800-668-9878
Email: Saskatoon@alsenviro.com

» **Midwest Laboratories Canada**
(www.midwestlabscanada.com)
#8, 4001B-19th Street N.E., Calgary AB T2E 6X8
Phone: (403) 250-3317 Fax: (403) 250-5249
Email: mwl@midwestlabscanada.com

» **Lakeside Labs**
PO Box 800, Brooks AB T1R 1B7
Phone: (403) 362-3326 Fax: (403) 362-8231
Email: leshured@myipplus.net

» **Sandberg Labs**
Sandberg Labs Ltd.
3510 - 6th Avenue N, Lethbridge AB T1H 5C3
Phone:(403) 328-1133 Fax:(403) 320-1033
Email: sandberg@agt.net

» **A&L Canada Laboratories Inc.**
2136 JetStream Rd., London ON N5V 3P5
Phone: (519) 457-2575 Fax: (519) 457-2664
Website: www.al-labs-can.com
Email: alcanadalabs@alcanada.com

Appendix 3D

How to Use a Slope Gauge

1. Photocopy the bottom portion of this page and mount to a wood surface approximately 8" x 9".
2. Tack nails in each of the three marked points on the sheet to use as sighting pins.
3. Attach a small weight to a 10" string and hang it from the nail on Point 1.
4. Keep the sighting pins in your line of vision and aim at the point on an object or person that is the **same height** from the ground as your eyes. For example, let's assume you're aiming at a person who is taller than you. If that person's chin is the same height from the ground as your eyes, aim for their chin (see illustration). If you're aiming at a stick, tie a ribbon around the point on the stick that is at your eye level then aim at the ribbon.

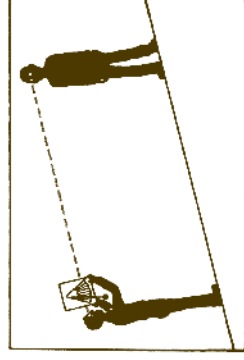

5. The person or object does not need to be any particular distance away.
6. You can aim the slope gauge either up or down the slope.
7. Hold the slope gauge as steady as possible and make sure the weighted string can swing easily across the scale.
8. After you have finished sighting, hold the string at the point where it comes to rest on the scale.
9. Read the percent of slope directly from the scale and record your measurement. You may want to take several measurements on the same slope to check your accuracy.

POINT 1

Hang weight on a string from this point

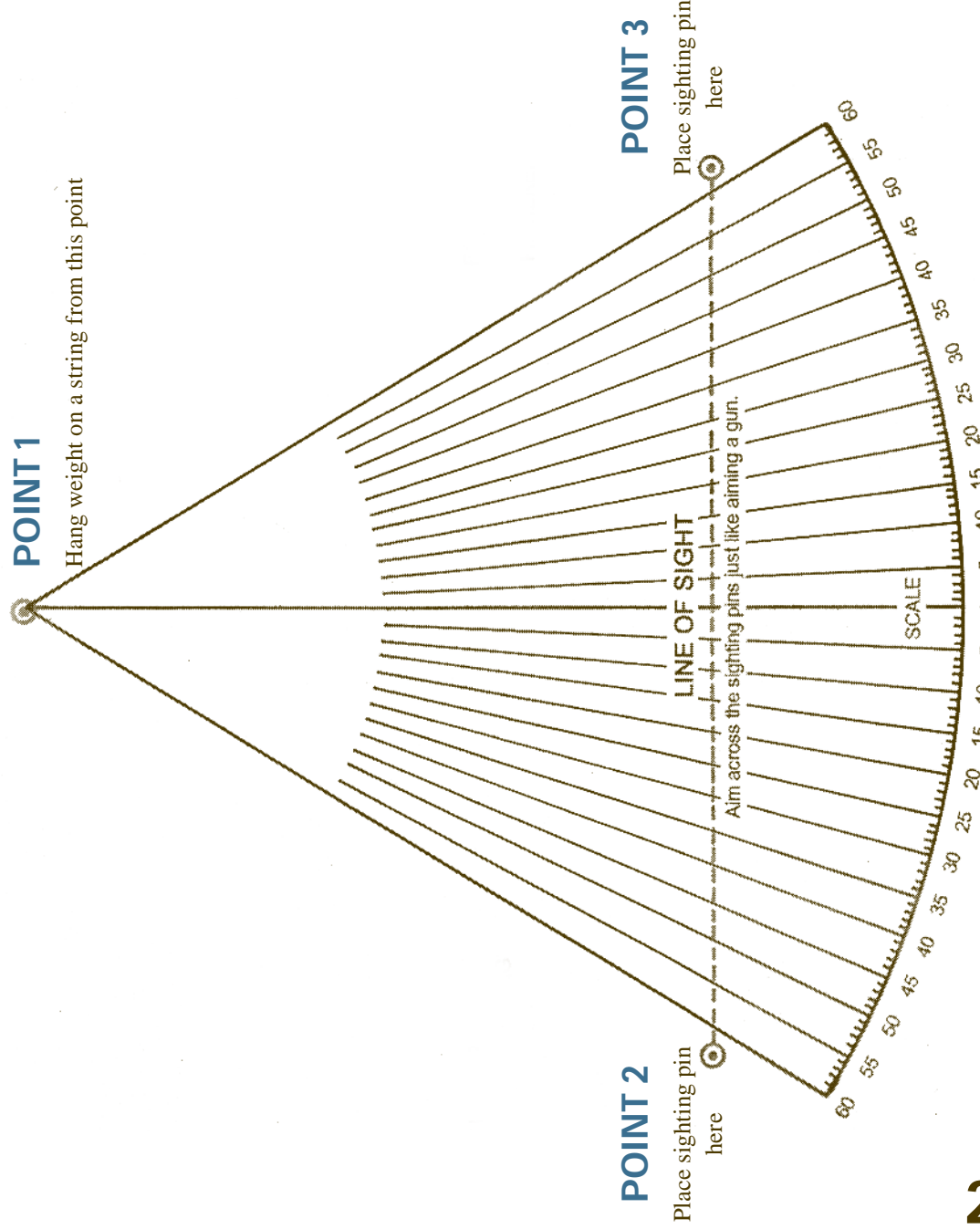

Read percent of slope directly on this scale. The point where string rests on scale indicates the percent of slope.

Appendix 4A

Standard Values for Manure Nutrient Content and Estimated Daily Manure Production

Table 4A-1. Standard Manure Nutrient Characteristic (as removed) for Common Classes of Livestock Adapted from the *Agricultural Operation Practices Act* (Province of Alberta 2001), Table 5 in Schedule 2 of the Standards and Administration Regulations.

Species/Class	Typical Nutrient Content (% of fresh manure)						
	Moisture ¹	Total N ¹	Avail N	Crop N	Total P ²	Total K ^{3,4}	
Beef	Feeders						
	Finishers						
Beef	Feeder calves	50 (30-70)	1.0 (0.65-1.25)	0.26	0.32	0.24	0.67
	Cow/calf pair						
Dairy	Cows/bulls						
	Paved feedlot	65 (50-75)	0.7 (0.45-0.80)	0.27	0.25	0.09	0.38
Dairy	Free-stall housing	92 (85-95)	0.40 (0.35-0.60)	0.18	0.17	0.09	0.42
	Tie-stall housing						
Dairy	Loose housed						
	Replacements	80 (70-85)	0.50 (0.45-0.65)	0.21	0.19	0.09	0.42
Dairy	Calves						
	Liquid	96 (90-99)	0.35 (0.20-0.55)	0.16	0.16	0.11	0.17
Swine	Solid	50 (40-70)	0.80 (0.60-0.90)	0.32	0.31	0.15	0.23
	Caged layers, belt removal (solid)	40 (30-60)	3.01 (2.50-3.50)	2.01	1.89	1.54	1.0
Poultry	Caged layers, deep pit (solid)	50 (30-60)	2.41 (2.00-3.00)	1.60	1.51	1.23	0.83
	Caged layers (liquid)	90 (85-95)	0.60 (0.50-1.00)	0.40	0.38	0.25	0.20
Poultry	Broilers replacement pullets	35 (30-50)	3.41 (3.50-4.00)	1.95	1.84	0.95	1.00
	Broiler breeders	35 (30-50)	3.01 (1.60-2.10)	1.72	1.63	0.95	1.00
Poultry	Turkey breeders	35 (30-50)	1.75 (1.50-2.00)	1.00	0.95	0.59	0.63
	Ewes w/ lambs						
Sheep	Ewes/rams	50 (30-65)	1.00 (0.62-1.25)	0.40	0.36	0.20	1.04
	Feeders						
Goats	Lambs	50 (30-65)	0.70 (0.50-1.00)	0.28	0.25	0.20	1.04
	Goats	50 (30-65)	0.63 (0.50-0.75)	0.25	0.23	0.23	1.04
Horses	Feedlot	50 (30-60)	1.50 (1.00-2.00)	0.75	0.71	0.23	1.04
	PMU	75 (50-80)	0.60 (0.50-0.70)	0.30	0.29	0.13	0.5
Horses	Donkeys						
	Mules	50 (30-70)	1.00 (0.80-1.10)	0.50	0.48	0.23	1.04

¹ Figure presented is average content, with observed range in values in brackets.

² To convert to P₂O₅, multiply number in table by 2.29

³ To convert to K₂O, multiply number in table by 1.20

⁴ From the 2000 Code of Practice for Responsible Livestock Development and Manure Management (AF 2000).

Table 4A-2. Standard Manure Nutrient Characteristics (as removed) for Common Classes of Livestock Adapted from Tri-Provincial Manure Application and Use Guidelines (2001)

Species/Class	Nutrient ¹ (% of fresh manure, except NH ₄ – N)				
	Moisture	Total N	NH ₄ – N ²	Total P	Total K
Liquid swine	96.6 (91.0-99.0)	0.31 (0.04-0.68)	1946 (230-5150)	0.10 (0.00-0.51)	0.14 (0.03-0.37)
Liquid dairy	91.1 (80.1-99.0)	0.34 (0.07-0.76)	1463 (21-7168)	0.09 (0.01-0.85)	0.32 (0.02-0.98)
Solid beef	74.6 (61.6-79.9)	0.60 (0.14-2.02)	564 (11-2656)	0.14 (0.03-0.64)	0.59 (0.16-2.54)
Liquid poultry	90.9 (81.3-97.4)	0.80 (0.30-1.42)	5751 (107-10510)	0.28 (0.06-0.51)	0.33 (0.16-0.53)

¹ Figures presented is average content, with observed range in values in brackets

² NH₄-N expressed in parts per million (ppm)

Appendix 4A

Table 4A-3. Standard Daily Manure Production Estimates for Common Classes of Livestock Adapted from the *Agricultural Operation Practices Act* (Province of Alberta 2004), Tables 5 and 6 in Schedule 2 of the Standards and Administration Regulations.

Species/Class		Solid				Liquid			
		Weight		Volume		Weight		Volume	
		kg	lbs	m ³	ft ³	L	gal ^l	m ³	ft ³
Beef	Feeders	3.8	8.4	0.0062	0.21	---	---	---	---
	Finishers - Open lot	6.0	13.1	0.0094	0.32	---	---	---	---
	Finishers - Paved lot	9.0	19.8	0.0126	0.43	---	---	---	---
	Feeder calves < 550lbs	1.5	3.3	0.0023	0.08	---	---	---	---
	Cow/calf pair	8.1	17.8	0.0129	0.44	---	---	---	---
	Cows/bulls	7.5	16.5	0.0117	0.40	---	---	---	---
Dairy (* count lactating cows only)	Free stall: Lactating cow only ²	---	---	---	---	98.6	21.7	0.099	3.50
	Free stall: Dry cow	---	---	---	---	43.0	9.5	0.042	1.50
	Free stall: Lactating with dry cows only ^{*3}	---	---	---	---	116.8	25.7	0.116	4.11
	Tie stall: Lactating cow only	63.5	139.7	0.0779	2.66	---	---	---	---
	Loose housing: Lactating cow only	66.5	146.3	0.0815	2.78	---	---	---	---
	Dry Cow	31.8	70.0	---	1.30	---	---	---	---
	Replacement heifers	19.5	42.9	0.0240	0.82	---	---	---	---
	Calves	1.3	2.9	0.0021	0.07	---	---	---	---
Swine (* count sows only)	Farrow-to-finish*	39.3	86.4	0.0510	1.74	65.7	14.44	0.065	2.31
	Farrow-to-wean*	12.1	26.6	0.0158	0.54	20.2	4.44	0.020	0.71
	Lactating sow*	9.7	21.3	0.0126	0.43	15.9	3.50	0.016	0.56
	Weaner pig	1.3	2.8	0.0018	0.06	2.3	0.50	0.002	0.08
	Feeder pig	3.7	8.2	0.0050	0.17	7.1	1.56	0.007	0.25
Poultry (/100 birds)	Caged layers, liquid	---	---	---	---	27	6.0	0.027	0.95
	Caged layers, belt manure removal	4.5	9.9	0.0120	0.41	---	---	---	---
	Caged layers, deep pit	5.9	13.0	0.0091	0.31	---	---	---	---
	Broilers	2.7	6.0	0.0088	0.30	---	---	---	---
	Broiler breeders	7.2	15.8	0.0173	0.59	---	---	---	---
	Layer breeders	5.3	11.7	0.0155	0.53	---	---	---	---
	Replacement pullets	2.7	6.0	0.0044	0.30	---	---	---	---
	Turkey hens, light	6.2	13.6	0.0249	0.85	---	---	---	---
	Turkey toms, heavy	9.0	19.8	0.0375	1.28	---	---	---	---
Turkey broilers	5.0	11.0	0.0149	0.51	---	---	---	---	
Horses	PMU, per head	20.8	45.8	0.0270	0.92	---	---	---	---
	Feedlot, per head	6.9	15.2	0.0135	0.46	---	---	---	---
	Donkeys	3.5	7.6	0.0067	0.23	---	---	---	---
	Mules	5.2	11.4	0.0103	0.35	---	---	---	---

Species/Class	Solid				Liquid				
	Weight		Volume		Weight		Volume		
	kg	lbs	m ³	ft ³	L	gal ¹	m ³	ft ³	
Sheep	Ewes w/ lambs	1.8	3.9	0.0038	0.13	---	---	---	---
	Ewes/rams	1.4	3.1	0.0029	0.10	---	---	---	---
	Feeders	0.7	1.5	0.0015	0.05	---	---	---	---
	Lambs	0.4	0.8	0.0006	0.02	---	---	---	---
Goats	Milk/meat (per ewe)	2.7	5.9	0.0054	0.19	---	---	---	---
	Feeders	0.3	0.60	0.0006	0.02	---	---	---	---
	Does/bucks	1.4	3.10	0.0029	0.10	---	---	---	---
Bison	Cows / bulls	3.3	7.3	0.0051	0.18	---	---	---	---

¹ Imperial gallons, equal to 1.2 US gallons

² Includes milking parlour wash-water of 30 L per lactating cow

³ Includes milking parlour wash-water of 30 L per lactating cow (zero milking parlour wash-water for dries)

APPENDIX 6A

Table 6A-1 Crop Nutrient Uptake and Removal Coefficients Ranges (Metric Units)

Crop	Units		Nitrogen (N)		Phosphate (P ₂ O ₅)		Potash (K ₂ O)		Sulphur (S)	
			Lower	Upper	Lower	Upper	Lower	Upper	Lower	Upper
Spring Wheat	kg/kg	Uptake	0.0316	0.0387	0.0121	0.0146	0.0271	0.0333	0.0033	0.0042
		Removal	0.0225	0.0275	0.0087	0.0108	0.0067	0.0079	0.0017	0.0021
Winter Wheat	kg/kg	Uptake	0.0203	0.0247	0.0090	0.0113	0.0213	0.0260	0.0030	0.0037
		Removal	0.0157	0.0190	0.0077	0.0093	0.0050	0.0063	0.0020	0.0027
Barley	kg/kg	Uptake	0.0260	0.0318	0.0104	0.0128	0.0250	0.0305	0.0031	0.0036
		Removal	0.0182	0.0221	0.0078	0.0096	0.0060	0.0073	0.0016	0.0021
Oats	kg/kg	Uptake	0.0300	0.0366	0.0113	0.0141	0.0409	0.0500	0.0038	0.0044
		Removal	0.0172	0.0213	0.0072	0.0088	0.0053	0.0063	0.0013	0.0016
Rye	kg/kg	Uptake	0.0269	0.0328	0.0133	0.0166	0.0380	0.0467	0.0045	0.0055
		Removal	0.0172	0.0208	0.0071	0.0088	0.0058	0.0071	0.0013	0.0016
Corn	kg/kg	Uptake	0.0246	0.0300	0.0102	0.0123	0.0207	0.0252	0.0023	0.0029
		Removal	0.0155	0.0191	0.0070	0.0086	0.0045	0.0054	0.0011	0.0013
Canola	kg/kg	Uptake	0.0571	0.0703	0.0263	0.0326	0.0417	0.0509	0.0097	0.0120
		Removal	0.0349	0.0423	0.0189	0.0229	0.0091	0.0114	0.0057	0.0069
Flax	kg/kg	Uptake	0.0465	0.0571	0.0135	0.0165	0.0293	0.0360	0.0090	0.0113
		Removal	0.0345	0.0420	0.0105	0.0128	0.0098	0.0120	0.0038	0.0045
Sunflower	kg/kg	Uptake	0.0335	0.0410	0.0115	0.0140	0.0165	0.0220	0.0040	0.0045
		Removal	0.0240	0.0295	0.0070	0.0090	0.0055	0.0065	0.0020	0.0025
Peas	kg/kg	Uptake	0.0460	0.0560	0.0127	0.0153	0.0410	0.0500	0.0037	0.0047
		Removal	0.0350	0.0430	0.0103	0.0127	0.0107	0.0130	0.0020	0.0023
Lentils	kg/kg	Uptake	0.0456	0.0561	0.0122	0.0150	0.0383	0.0467	0.0044	0.0056
		Removal	0.0306	0.0372	0.0094	0.0111	0.0161	0.0200	0.0022	0.0028
Fababeans	kg/kg	Uptake	0.0756	0.0924	0.0262	0.0318	0.0674	0.0824	0.0035	0.0044
		Removal	0.0453	0.0553	0.0162	0.0197	0.0138	0.0168	0.0018	0.0024
Sugarbeets	kg/tonne	Uptake	4.3077	5.2599	1.3830	1.7004	7.8672	9.6130	0.6802	0.8162
		Removal	1.7911	2.1992	0.8162	1.0202	2.9020	3.5595	0.2721	0.3174
Potatoes	kg/tonne	Uptake	5.1250	6.2750	1.5000	1.8250	6.7000	8.1750	0.4000	0.5000
		Removal	2.8750	3.5250	0.8250	1.0000	4.8500	5.9500	0.2750	0.3250
Alfalfa DM ¹	kg/tonne	Uptake								
		Removal	26.1000	31.9000	6.2000	7.6000	27.0000	33.0000	2.7000	3.3000
Clover DM ¹	kg/tonne	Uptake								
		Removal	24.1422	29.4933	6.2222	7.5911	22.5244	27.6267	1.2444	1.4933
Grass DM ¹	kg/tonne	Uptake								
		Removal	15.3791	18.8896	4.5134	5.5164	19.5582	23.9045	1.8388	2.3403
Barley Silage DM ¹	kg/tonne	Uptake								
		Removal	14.5600	20.1600	5.1520	6.7200	12.7680	14.7840	1.5680	2.3520
Corn Silage DM ¹	kg/tonne	Uptake								
		Removal	14.0000	17.2000	5.7000	7.0000	18.1000	22.2000	1.2000	1.4000

¹ DM = Dry Matter

Table 6A-2 Crop Nutrient Uptake and Removal Coefficients Ranges (Imperial Units)

Crop	Units		Nitrogen (N)		Phosphate (P ₂ O ₅)		Potash (K ₂ O)		Sulphur (S)	
			Lower	Upper	Lower	Upper	Lower	Upper	Lower	Upper
Spring Wheat	lb/bu	Uptake	1.9000	2.3250	0.7250	0.8750	1.6250	2.0000	0.2000	0.2500
		Removal	1.3500	1.6500	0.5250	0.6500	0.4000	0.4750	0.1000	0.1250
Winter Wheat	lb/bu	Uptake	1.2200	1.4800	0.5400	0.6800	1.2800	1.5600	0.1800	0.2200
		Removal	0.9400	1.1400	0.4600	0.5600	0.3000	0.3800	0.1200	0.1600
Barley	lb/bu	Uptake	1.2500	1.5250	0.5000	0.6125	1.2000	1.4625	0.1500	0.1750
		Removal	0.8750	1.0625	0.3750	0.4625	0.2875	0.3500	0.0750	0.1000
Oats	lb/bu	Uptake	0.9600	1.1700	0.3600	0.4500	1.3100	1.6000	0.1200	0.1400
		Removal	0.5500	0.6800	0.2300	0.2800	0.1700	0.2000	0.0400	0.0500
Rye	lb/bu	Uptake	1.5091	1.8364	0.7455	0.9273	2.1273	2.6182	0.2545	0.3091
		Removal	0.9636	1.1636	0.4000	0.4909	0.3273	0.4000	0.0727	0.0909
Corn	lb/bu	Uptake	1.3800	1.6800	0.5700	0.6900	1.1600	1.4100	0.1300	0.1600
		Removal	0.8700	1.0700	0.3900	0.4800	0.2500	0.3000	0.0600	0.0700
Canola	lb/bu	Uptake	2.8571	3.5143	1.3143	1.6286	2.0857	2.5429	0.4857	0.6000
		Removal	1.7429	2.1143	0.9429	1.1429	0.4571	0.5714	0.2857	0.3429
Flax	lb/bu	Uptake	2.5833	3.1667	0.7500	0.9167	1.6250	2.0000	0.5000	0.6250
		Removal	1.9167	2.3333	0.5833	0.7083	0.5417	0.6667	0.2083	0.2500
Sunflower	lb/bu	Uptake	1.3400	1.6400	0.4600	0.5600	0.6600	0.8800	0.1600	0.1800
		Removal	0.9600	1.1800	0.2800	0.3600	0.2200	0.2600	0.0800	0.1000
Peas	lb/bu	Uptake	2.7600	3.3600	0.7600	0.9200	2.4600	3.0000	0.2200	0.2800
		Removal	2.1000	2.5800	0.6200	0.7600	0.6400	0.7800	0.1200	0.1400
Lentils	lb/bu	Uptake	2.7333	3.3667	0.7333	0.9000	2.3000	2.8000	0.2667	0.3333
		Removal	1.8333	2.2333	0.5667	0.6667	0.9667	1.2000	0.1333	0.1667
Fababeans	lb/bu	Uptake	5.1400	6.2800	1.7800	2.1600	4.5800	5.6000	0.2400	0.3000
		Removal	3.0800	3.7600	1.1000	1.3400	0.9400	1.1400	0.1200	0.1600
Sugarbeets	lb/ton	Uptake	8.6364	10.5455	2.7727	3.4091	15.7727	19.2727	1.3636	1.6364
		Removal	3.5909	4.4091	1.6364	2.0455	5.8182	7.1364	0.5455	0.6364
Potatoes	lb/ton	Uptake	10.2500	12.5500	3.0000	3.6500	13.4000	16.3500	0.8000	1.0000
		Removal	5.7500	7.0500	1.6500	2.0000	9.7000	11.9000	0.5500	0.6500
Alfalfa DM ¹	lb/ton	Uptake								
		Removal	52.2000	63.8000	12.4000	15.2000	54.0000	66.0000	5.4000	6.6000
Clover DM ¹	lb/ton	Uptake								
		Removal	48.5000	59.2500	12.5000	15.2500	45.2500	55.5000	2.5000	3.0000
Grass DM ¹	lb/ton	Uptake								
		Removal	30.6667	37.6667	9.0000	11.0000	39.0000	47.6667	3.6667	4.6667
Barley Silage DM ¹	lb/ton	Uptake								
		Removal	28.8889	40.0000	10.2222	13.3333	25.3333	29.3333	3.1111	4.6667
Corn Silage DM ¹	lb/ton	Uptake								
		Removal	28.0000	34.4000	11.4000	14.0000	36.2000	44.4000	2.4000	2.8000

¹ DM = Dry Matter

Derived from Nutrient Uptake and Removal by Field Crops, Western Canada, 2001, Compiled by the Canadian Fertilizer Institute (CFI)

Appendix 6B

Calculating Expected Nutrient Uptake and Removal

Tables 6A-1 and 6A-2 (Appendix 6A) provide coefficient ranges to estimate crop nutrient uptake and removal based on expected or measured crop yields.



For a barley yield of 70 bu/ac, the expected range of nutrients taken up by the barley is

Crop Nitrogen Uptake (lb N/ac) = Yield (bu/ac) X Uptake Coefficient (lb N/bu) (Table 6A-2)

Using lower coefficient Crop N Uptake = 87.5 lb N /ac = 70 bu/ac x 1.2500 lb N/bu

Using upper coefficient Crop N Uptake = 106.8 lb N/ac = 70 bu/ac X 1.5250 lb N/bu

A 70 bu/ac barley would be expected to take up between 87.5 to 106.8 lb N/ac in the total biomass (grain and straw).

For the barley yield of 70 bu/ac, the expected range of nutrients removed in the grain is

Crop Nitrogen Removal (lb N/ac) = Yield (bu/ac) X Removal Coefficient (lb N/bu) (Table 6A-2)

Lower 61.3 lb N/ac = 70 bu/ac X 0.8750 lb N/bu

Upper 74.4 lb N/ac = 70 bu/ac X 1.0625 lb N/bu

A 70 bu/ac barley would be expected to remove between 61.3 to 74.4 lb N/ac in the grain removed from the field.

A barley silage crop with a yield of 6 tons/ac at 50% moisture is equivalent to 3 tons/ac dry matter

$$\begin{aligned} \text{Yield}_{\text{Dry Matter}} &= \text{Yield}_{50\% \text{ Moisture}} / (100/(100-\% \text{ Moisture})) \\ &= 6 \text{ tons/ac} / (100/(100-50)) \\ &= 3 \text{ tons/ac} \end{aligned}$$

For the barley silage yield of 3 tons/ac of dry matter, the expected range of nutrients removed in the grain is

Nutrient Uptake (lb N/ac) = Yield_{Dry Matter} (tons/ac) x Uptake Coefficient (lb N/ton) (Table 6A-2)

Nitrogen: Lower 86.7 lb N/ac = 3 tons/ac X 28.8889 lb/ton

Upper 120 lb N/ac = 3 tons/ac X 40.0000 lb/ton

A 6 ton/ac barley silage crop at 50% moisture would be expected to take up between 86.7 and 120.0 lb N/ac in the total silage biomass (grain and straw).

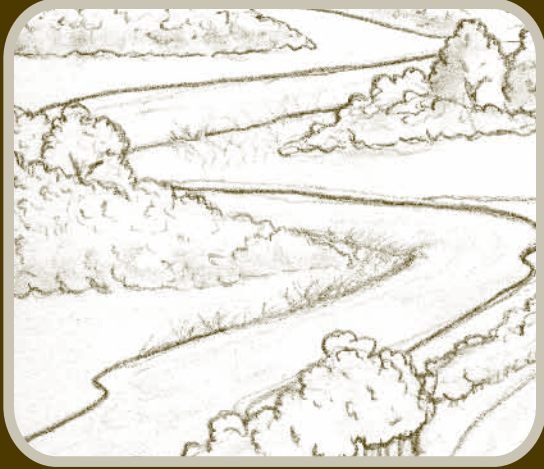

References

Sources of information used in this manual can be found listed alphabetically in the attached references:

- Module 1.0
- Module 2.0
- Module 3.0
- Module 4.0
- Module 5.0
- Module 6.0
- Module 7.0
- Module 8.0

Module 1.0

Alberta Agriculture Food and Rural Development. 2005. Alberta Farm Fertilizer Information and Recommendation Manager (AFFIRM). [Online] Available: [www1.agric.gov.ab.ca/\\$department/deptdocs.nsf/all/crop10159](http://www1.agric.gov.ab.ca/$department/deptdocs.nsf/all/crop10159) [1 Jan 2007]

Alberta Agriculture Food and Rural Development. 2005. Alberta Manure Management Planner – 2005. [Online] Available: [www1.agric.gov.ab.ca/\\$department/deptdocs.nsf/all/epw8834](http://www1.agric.gov.ab.ca/$department/deptdocs.nsf/all/epw8834) [1 Jan 2007]

Alberta Agriculture Food and Rural Development. 2006. Crop Calculators. [Online] Available: www.agric.gov.ab.ca/app19/calc/index.jsp?type=Crop [1 Jan 2007]

Alberta Agriculture Food and Rural Development. 2006. Homepage. [Online] Available: www.ropintheweb.com [1 Jan 2007]

Alberta Environmentally Sustainable Agriculture Program. 2006. Rural Extension Staff Directory. [Online] Available: www.aesa.ca/new/staff_rural.cfm [1 Jan 2007]

Boehme, P. 2004. 2004 Reference guide: Agricultural Operation Practices Act (2nd Ed). Alberta Agriculture Food and Rural Development. Agdex 096-1. [Online] Available: [www1.agric.gov.ab.ca/\\$department/deptdocs.nsf/all/epw8746](http://www1.agric.gov.ab.ca/$department/deptdocs.nsf/all/epw8746) [1 Jan 2007].

Prairie Certified Crop Advisor Board. 2006. Homepage. [Online] Available: www.prairiecca.ca/ [1 Jan 2007]

Module 2.0

Barker, B. 2006. April. Do you really need crop micronutrients? Top Crop Manager [Online] Available: http://www.topcropmanager.com/6_search/article.asp?article=2187 [1 Jan 2007]

Beegle, D.B. 2006. Crop and soil management. Section 2, the agronomy guide: 2005-06. The Pennsylvania State University. [Online] Available: <http://agguide.agronomy.psu.edu/cm/sec2/sec2toc.cfm> [1 Jan 2007]

Brady, N.C. and Weil, R.R. 2000. The nature and properties of soils (13th ed.). Prentice Hall, Upper Saddle River, NJ. 960 pg.

Gburek, W.J. 2000. Nutrient and pathogen transport in the watershed. Pages 227-236 in Managing nutrients and pathogens from animal agriculture, Camp Hill, PA, Mar 28-30, 2000. Natural Resource, Agriculture, and Engineering Service (Publication NRAES-130).

Hausenbuiller, R.L. 1985. Soil science: Principles and practices (3rd ed.). William C. Brown Publishers, Dubuque, IA. 610 pg.

Havlin, J.L., Beaton, J.D., Tisdale, S.L. and Nelson, W.L. 2005. Soil fertility and fertilizers: An introduction to nutrient management (7th ed.). Prentice Hall, Upper Saddle River, NJ. 515 pg.

Jones, C. and Jacobsen, J. 2001a. Nitrogen cycling, testing and fertilizer recommendations. Nutrient management module 3. Montana State University Extension Service. Publication 4449-3. [Online] Available: <http://landresources.montana.edu/NM/Modules/NM%203%20mt44493.pdf> [1 Jan 2007]

Jones, C. and Jacobsen, J. 2001b. Plant nutrition and soil fertility. Nutrient management module 2. Montana State University Extension Service. Publication 4449-2. [Online] Available: <http://landresources.montana.edu/NM/Modules/NM%202%20mt44492.pdf> [1 Jan 2007]

- Jones, C. and Jacobsen, J. 2002a. Phosphorus cycling, testing and fertilizer recommendations. Nutrient management module 4. Montana State University Extension Service. Publication 4449-4. [Online] Available: <http://landresources.montana.edu/NM/Modules/NM%204%20mt44494.pdf> [1 Jan 2007]
- Jones, C. and Jacobsen, J. 2002b. Potassium cycling, testing and fertilizer recommendations. Nutrient management module 5. Montana State University Extension Service. Publication 4449-5. [Online] Available: <http://landresources.montana.edu/NM/Modules/NM%205%20mt44495.pdf> [1 Jan 2007]
- Jones, C. and Jacobsen, J. 2003a. Fertilizer placement and timing. Nutrient management module 11. Montana State University Extension Service. Publication 4449-11. [Online] Available: <http://landresources.montana.edu/NM/Modules/NM11layout.pdf> [1 Jan 2007]
- Jones, C. and Jacobsen, J. 2003b. Micronutrients: Cycling, testing and fertilizer recommendations. Nutrient management module 7. Montana State University Extension Service. Publication 4449-7. [Online] Available: <http://landresources.montana.edu/NM/Modules/Module7.pdf> [1 Jan 2007]
- Karamanos, R. 2006. Micronutrients for irrigated production. Proceedings, Irrigated Crop Production Update Conference. January 17th, 2006. Alberta Agriculture and Food. [Online] Available: [http://www1.agric.gov.ab.ca/\\$department/deptdocs.nsf/all/ind10751](http://www1.agric.gov.ab.ca/$department/deptdocs.nsf/all/ind10751) [1 Jan 2007]
- Koelsch, R. Not dated. Lesson 1: Environmental stewardship. Livestock and poultry environmental stewardship curriculum. [Online] Available: www.lpes.org/Lessons/Lesson01/1_Environmental_Stewardship.html [1 Jan 2007]
- Korb, N. and Jacobsen, J. 2002. Secondary macronutrients: Cycling, testing and fertilizer recommendations. Nutrient management module 6. Montana State University Extension Service. Publication 4449-6. [Online] Available: <http://landresources.montana.edu/NM/Modules/NM%206%20mt44496.pdf> [1 Jan 2007]
- Kryzanowski, L. 2002. Liming acid soils. Alberta Agriculture and Food. Agdex 534-1. [Online] Available: [http://www1.agric.gov.ab.ca/\\$department/deptdocs.nsf/all/agdex3684?opendocument](http://www1.agric.gov.ab.ca/$department/deptdocs.nsf/all/agdex3684?opendocument) [1 Jan 2007]
- Kryzanowski, L. 2004. Alberta fertilizer guide. Alberta Agriculture and Food. Agdex 541-1. [Online] Available: [http://www1.agric.gov.ab.ca/\\$department/deptdocs.nsf/all/agdex3894?opendocument](http://www1.agric.gov.ab.ca/$department/deptdocs.nsf/all/agdex3894?opendocument) [1 Jan 2007]
- Lickacz, J. and Penny, D. 2001. Soil organic matter. Alberta Agriculture and Food. Agdex 536-1. [Online] Available: [http://www1.agric.gov.ab.ca/\\$department/deptdocs.nsf/all/agdex890?opendocument](http://www1.agric.gov.ab.ca/$department/deptdocs.nsf/all/agdex890?opendocument) [1 Jan 2007]
- McCauley, A., Jones, C. and Jacobsen, J. 2003. Commercial fertilizers and soil amendments. Nutrient management module 10. Montana State University Extension Service. Publication 4449-10. [Online] Available: <http://landresources.montana.edu/NM/Modules/NM10layout.pdf> [1 Jan 2007]
- McKenzie, R. 1992. Micronutrient requirements of crops. Alberta Agriculture and Food. Agdex 531-1. [Online] Available: [http://www1.agric.gov.ab.ca/\\$department/deptdocs.nsf/all/agdex713?opendocument](http://www1.agric.gov.ab.ca/$department/deptdocs.nsf/all/agdex713?opendocument) [1 Jan 2007]
- McKenzie, R. 1998. Crop nutrition and fertilizer requirements. Alberta Agriculture and Food. Agdex 540-1. [Online] Available: [http://www1.agric.gov.ab.ca/\\$department/deptdocs.nsf/all/agdex3791?opendocument](http://www1.agric.gov.ab.ca/$department/deptdocs.nsf/all/agdex3791?opendocument) [1 Jan 2007]

- McKenzie, R. 2003. Soil pH and plant nutrient. Alberta Agriculture and Food. Agdex 531-4. [Online] Available: [http://www1.agric.gov.ab.ca/\\$department/deptdocs.nsf/all/agdex6607?opendocument](http://www1.agric.gov.ab.ca/$department/deptdocs.nsf/all/agdex6607?opendocument) [1 Jan 2007]
- McNeil, B., Sawyer, B.J., Hoar, G. and Bowen, C.M. 1998. Manure as a resource. Pages 39-46 in E. Olson, ed. Nutrient management for livestock production (workshop participant package). P40 Visual Communications, Edmonton, AB.
- McNeil, B., Sawyer, B.J., Hoar, G. and Bowen, C.M. 1998. Manure as a source of contamination. Pages 47-54 in E. Olson, ed. Nutrient management for livestock production (workshop participant package). P40 Visual Communications, Edmonton, AB.
- Mengel, D.B. Not dated. Fundamentals of soil cation exchange capacity (CEC). Purdue University, Department of Agronomy. Publication AY-238. [Online] Available: <http://www.ces.purdue.edu/extmedia/AY/AY-238.html> [1 Jan 2007]
- Miller, R.W. and Donohue, R.L. 1990. Soils: An introduction to soils and plant growth (6th ed.). Prentice Hall, Upper Saddle River, NJ. 768 pg.
- Mortvedt, J. 2001. Calculating salt index. [Online] Available: <http://www.puregrade.com/Pdf/TB2-1.pdf> [1 Jan 2007]
- Schulte, E.E. and Kelling, K.A. Not dated. Understanding plant nutrients: Soil and applied sulfur. University of Wisconsin – Extension. Factsheet A2525. [Online] Available: <http://learningstore.uwex.edu/pdf/A2525.pdf> [1 Jan 2007]
- Seelig, B.D. 2000. Salinity and sodicity in North Dakota soils. North Dakota State University. Publication EB 57. [Online] Available: <http://www.ag.ndsu.edu/pubs/plantsci/soilfert/eb57-1.htm> [1 Jan 2007]
- Wallace, T. 2004. Tri-Provincial manure application and use guidelines: Alberta version. Prairie Provinces' Committee on Livestock Development and Manure Management. [Online] Available: [www1.agric.gov.ab.ca/\\$department/deptdocs.nsf/all/epw8709](http://www1.agric.gov.ab.ca/$department/deptdocs.nsf/all/epw8709) [1 Jan 2007].
- Wallace, T. 2005. Nutrient management plans: defining the key components for Alberta producers. Manure Management Planning: The Essentials. January 19th, 2005. Lethbridge, AB. [Online] Available: [http://agapps16.agric.gov.ab.ca/\\$department/deptdocs.nsf/all/epw9862](http://agapps16.agric.gov.ab.ca/$department/deptdocs.nsf/all/epw9862) [1 Jan 2007].
- Wentz, D. 2000. Dryland saline seeps: Types and causes. Alberta Agriculture and Food. Agdex 518-12. [Online] Available: [http://www1.agric.gov.ab.ca/\\$department/deptdocs.nsf/all/agdex167?opendocument](http://www1.agric.gov.ab.ca/$department/deptdocs.nsf/all/agdex167?opendocument) [1 Jan 2007]
- Wentz, D. 2001. Salt tolerance of plants. Alberta Agriculture and Food. Agdex 518-17. [Online] Available: [www1.agric.gov.ab.ca/\\$department/deptdocs.nsf/all/agdex3303?opendocument](http://www1.agric.gov.ab.ca/$department/deptdocs.nsf/all/agdex3303?opendocument) [1 Jan 2007]

Module 3.0

A & L Canada Laboratories, Inc. 2006. Homepage. Available: <http://www.al-labs-can.com/main.html> [1 Jan 2007].

Soils Branch. 1985a. Chapter 1: Soil properties. Alberta soils course. Home Study Section, Alberta Agriculture. 37 pg.

Soils Branch. 1985b. Chapter 5: Soil salinity. Alberta soils course. Home Study Section, Alberta Agriculture. 23 pg.

Soils Branch. 1985c. Chapter 6: Solonetzic soils. Alberta soils course. Home Study Section, Alberta Agriculture. 24 pg.

- Soils Branch. 1985d. Chapter 7: Acid soils. Alberta soils course. Home Study Section, Alberta Agriculture. 25 pg.
- Soils Branch. 1985e. Chapter 8: Gray wooded and peat soil management. Alberta soils course. Home Study Section, Alberta Agriculture. 40 pg.
- Alberta Agriculture and Food. 2005. Beneficial management practices: Environmental manual for crop producers in Alberta. Agdex 100/25-1. 165 pg. [Online] Available: [www1.agric.gov.ab.ca/\\$department/deptdocs.nsf/all/agdex9483](http://www1.agric.gov.ab.ca/$department/deptdocs.nsf/all/agdex9483) [1 Jan 2007]
- Arnold, R.H. 1997. Interpretation of airphotos and remotely sensed imagery. Prentice Hall, Upper Saddle River, NJ. 249 pg.
- Brady, N.C. and Weil, R.R. 2000. The nature and properties of soils (13th ed.). Prentice Hall, Upper Saddle River, NJ. 960 pg.
- Conservation and Development Branch. 1998. Emergency wind erosion control measures. Alberta Agriculture and Food. Adgex 572-1. [Online] Available: [www1.agric.gov.ab.ca/\\$department/deptdocs.nsf/all/agdex3961?opendocument](http://www1.agric.gov.ab.ca/$department/deptdocs.nsf/all/agdex3961?opendocument) [1 Jan 2007]
- Envirotest Laboratories (now ALS Environmental). 2006. ALS Environmental, agricultural services. [Online] Available: www.alsenviro.com/ag/index.html [1 Jan 2007].
- Glossary of Terms in Soil Science, Research Branch revised 1976 Canada Department of Agriculture, Ottawa, Publication 1459.
- Hausenbuiller, R.L. 1985. Soil science: Principles and practices (3rd ed.). William C. Brown Publishers, Dubuque, IA. 610 pg.
- Kryzanowski, L. (editor), Laverty, D., Ashworth, J., Nyborg, M., Harapiak, J. and Kucey, R. 1988. Soil test recommendations for Alberta: Technical manual. Alberta Agriculture.
- Kryzanowski, L. 1987. How to get the most from your soil test report. Agdex 533. Alberta Agriculture.
- Kryzanowski, L. 1996. Liming acid soils. Alberta Agriculture and Food. Agdex 534-1. [Online] Available: [www1.agric.gov.ab.ca/\\$department/deptdocs.nsf/all/agdex3684?opendocument](http://www1.agric.gov.ab.ca/$department/deptdocs.nsf/all/agdex3684?opendocument) [1 Jan 2007]
- Kryzanowski, L. 2004. Alberta fertilizer guide. Alberta Agriculture and Food. Agdex 541-1. [Online] Available: [http://www1.agric.gov.ab.ca/\\$department/deptdocs.nsf/all/agdex3894?opendocument](http://www1.agric.gov.ab.ca/$department/deptdocs.nsf/all/agdex3894?opendocument) [1 Jan 2007]
- Kryzanowski, L. 2004. Nutrient management tools for agronomic decisions. Alberta Agriculture and Food. [Online] Available: [www1.agric.gov.ab.ca/\\$department/deptdocs.nsf/all/crop8175](http://www1.agric.gov.ab.ca/$department/deptdocs.nsf/all/crop8175) [1 Jan 2007].
- Kryzanowski, L. 2005. Soil sampling and crop nutrient requirements: Critical tools for the nutrient management toolkit. [Online] Available: [www1.agric.gov.ab.ca/\\$department/deptdocs.nsf/all/epw9888](http://www1.agric.gov.ab.ca/$department/deptdocs.nsf/all/epw9888) [1 Jan 2007].
- Kryzanowski, L. and Kelbert, A. 2006. Soil nitrogen mineralization estimation for Alberta soils. Alberta Soil Science Workshop. . [Online] Available: <http://www.soilsworkshop.ab.ca/schedule.cfm?ViewYear=2006> [1 Jan 2007]
- Landva, A.O., E.O. Karpijaaka and P.E. Pleeney (1983) Geotechnical classification of peats and organic soils. p. 37-51. In: Testing of Peats and Organic Soils. ASTMSTP820, Am. Soc. Test. Mat. 241 pp.

- Lickacz, J. 1993. Management of solonetzic soils. Alberta Agriculture and Food. Agdex 518-8. [Online] Available: [www1.agric.gov.ab.ca/\\$department/deptdocs.nsf/all/agdex166?opendocument](http://www1.agric.gov.ab.ca/$department/deptdocs.nsf/all/agdex166?opendocument) [1 Jan 2007]
- Lickacz, J. 2002. Wood ash: An alternative liming material for agricultural soils. Alberta Agriculture and Food. Agdex 534-2. [Online] Available: [www1.agric.gov.ab.ca/\\$department/deptdocs.nsf/all/agdex3435?opendocument](http://www1.agric.gov.ab.ca/$department/deptdocs.nsf/all/agdex3435?opendocument) [1 Jan 2007]
- McKenzie, R. 1998. Crop nutrition and fertilizer requirements. Alberta Agriculture and Food. Agdex 540-1. [Online] Available: [www1.agric.gov.ab.ca/\\$department/deptdocs.nsf/all/agdex3791](http://www1.agric.gov.ab.ca/$department/deptdocs.nsf/all/agdex3791) [1 Jan 2007].
- McKenzie, R. 2001. Micronutrient requirements of crops. Alberta Agriculture, Food & Rural Development. Agdex 531-1. [Online] Available: [www1.agric.gov.ab.ca/\\$department/deptdocs.nsf/all/agdex713?opendocument](http://www1.agric.gov.ab.ca/$department/deptdocs.nsf/all/agdex713?opendocument) [1 Jan 2007].
- McKenzie, R. 2002. Fertilizing eroded knolls. Alberta Agriculture and Food. Agdex 541-2. [Online] Available: [www1.agric.gov.ab.ca/\\$department/deptdocs.nsf/all/agdex5694?opendocument](http://www1.agric.gov.ab.ca/$department/deptdocs.nsf/all/agdex5694?opendocument) [1 Jan 2007]
- McKenzie, R. and Kryzanowski, L. 2003. Fertilizing irrigated grain and oilseed crops. Alberta Agriculture and Food. Agdex FS100/540-1 [Online] Available: [www1.agric.gov.ab.ca/\\$department/deptdocs.nsf/all/agdex149?opendocument](http://www1.agric.gov.ab.ca/$department/deptdocs.nsf/all/agdex149?opendocument) [1 Jan 2007].
- McNeil, B., Sawyer, B.J., Hoar, G. and Bowen, C.M. 1998a. Land resources. Pages 25-38 in E. Olson, ed. Nutrient management for livestock production (workshop participant package). P40 Visual Communications, Edmonton, AB.
- McNeil, B., Sawyer, B.J., Hoar, G. and Bowen, C.M. 1998b. Using aerial photography. Pages 21-24 in E. Olson, ed. Nutrient management for livestock production (workshop participant package). P40 Visual Communications, Edmonton, AB.
- McNeil, R.L. and Sawyer, B.J. 1998c. Using aerial photography. Pages 15-21 in R.L. McNeil and B.J. Sawyer, eds. Land resource planning with a focus on manure management (workshop participant package). LandWise, Inc. 219 pg.
- Midwest Laboratories Canada. 1999. Homepage. [Online] Available: www.midwestlabscanada.com/ [1 Jan 2007].
- Miller, R.W. and Donohue, R.L. 1990. Soils: An introduction to soils and plant growth. Prentice Hall, Upper Saddle River, NJ. 768 pg.
- Montana State University. 2006. Paul Brown Soil Moisture Probe: Easy, inexpensive method for determining soil moisture. Department of Land Resources and Environmental Science. [Online] <http://landresources.montana.edu/PaulBrownProbe/index.htm> [1 Jan 2007].
- Norwest Labs (now Bodycote). 2006. Homepage. [Online] Available: www.norwestlabs.com/ [1 Jan 2007].
- Siemens, J.C., Hoef, R.G. and Pauli A.W. 1993. Soil management. Deere and Company Service Publications. Moline, IL. 132 pg.
- Soil Classification Working Group. 1998. The Canadian system of soil classification (3rd ed.). Agriculture and Agri-Food Canada. Publication 1646. 187 pg.

- Soil Conservation Service. 1991. Soil-plant-water relationships. Chapter 1, Section 15: Irrigation, National Engineering Handbook. United States Department of Agriculture. [Online] Available: <http://www.info.usda.gov/CED/ftp/CED/neh15-01.pdf> [1 Jan 2007]
- Timmermans, J. and Larney, F. 1998. An introduction to wind erosion control. Alberta Agriculture and Food. Agdex 572-2. [Online] Available: [http://www1.agric.gov.ab.ca/\\$department/deptdocs.nsf/all/agdex3524?opendocument](http://www1.agric.gov.ab.ca/$department/deptdocs.nsf/all/agdex3524?opendocument) [1 Jan 2007]
- United States Department of Agriculture. 2006. Natural Resources Conservation Service, Photo gallery. [Online] Available: <http://photogallery.nrcs.usda.gov/> [1 Jan 2007]
- Vanderwel, D. and Abday, S. 1997. An introduction to water erosion control. Alberta Agriculture and Food. Agdex 572-3. [Online] Available: [www1.agric.gov.ab.ca/\\$department/deptdocs.nsf/all/agdex2074?opendocument](http://www1.agric.gov.ab.ca/$department/deptdocs.nsf/all/agdex2074?opendocument) [1 Jan 2007]
- Wentz, D. 1997a. Annual crops for recharge control of saline seeps. Alberta Agriculture and Food. Agdex 518-14. [Online] Available: [www1.agric.gov.ab.ca/\\$department/deptdocs.nsf/all/agdex3514?opendocument](http://www1.agric.gov.ab.ca/$department/deptdocs.nsf/all/agdex3514?opendocument) [1 Jan 2007]
- Wentz, D. 1997b. Perennial crops for recharge control of saline seeps. Alberta Agriculture and Food. Agdex 518-13. [Online] Available: [www1.agric.gov.ab.ca/\\$department/deptdocs.nsf/all/agdex168?opendocument](http://www1.agric.gov.ab.ca/$department/deptdocs.nsf/all/agdex168?opendocument) [1 Jan 2007]
- Wentz, D. 1997c. Perennial crops for salinity control in discharge areas. Alberta Agriculture and Food. Agdex 518-15. [Online] Available: [www1.agric.gov.ab.ca/\\$department/deptdocs.nsf/all/agdex170?opendocument](http://www1.agric.gov.ab.ca/$department/deptdocs.nsf/all/agdex170?opendocument) [1 Jan 2007]
- Wentz, D. 1998. Structural controls for dryland saline seeps. Alberta Agriculture and Food. Agdex 518-16. [Online] Available: [www1.agric.gov.ab.ca/\\$department/deptdocs.nsf/all/agdex171?opendocument](http://www1.agric.gov.ab.ca/$department/deptdocs.nsf/all/agdex171?opendocument) [1 Jan 2007]
- Wentz, D. 2000. Dryland saline seeps: types and causes. Alberta Agriculture and Food. Agdex 518-12. [Online] Available: [www1.agric.gov.ab.ca/\\$department/deptdocs.nsf/all/agdex167?opendocument](http://www1.agric.gov.ab.ca/$department/deptdocs.nsf/all/agdex167?opendocument) [1 Jan 2007]
- Wentz, D. 2001. Salt tolerance of plants. Alberta Agriculture and Food. Agdex 518-17. [Online] Available: [www1.agric.gov.ab.ca/\\$department/deptdocs.nsf/all/agdex3303?opendocument](http://www1.agric.gov.ab.ca/$department/deptdocs.nsf/all/agdex3303?opendocument) [1 Jan 2007]
- Campbell, C.A., Jame Y.W., Jalil, A. and Schoenau, J. 1997. Use of hot KCl-NH₄-N to estimate N requirements. Can J. Soil Sci. 77:161-166.
- Campbell, C.A., Jame, Y.W. and Winkleman, G.E.. 1984. Mineralization rate constants and their use for estimating nitrogen mineralization in some Canadian prairie soils. Can. J. Soil Sci. 64: 333-343.
- Jalil, A. Campbell, C.A., Schoenau, J., Henry, J.L., Jame, W. and Lafond, G.P. 1996. Assessment of two chemical extraction methods as indices of available N. Soil Sci. Soc. Am. J. 60: 1954-1960.
- Reinl, E. 1984. Changes in soil organic carbon due to agricultural land use in Alberta. M.Sc. Thesis, Department of Soil Science, University of Alberta.
- Research Branch. 1976. Glossary of terms in soil science. Canada Department of Agriculture, Ottawa. Publication 1459. 44 pg.

Module 4.0

A & L Canada Laboratories, Inc. 2006. Homepage. Available: <http://www.al-labs-can.com/main.html> [1 Jan 2007].

AAFRD. 2006. Agricultural Operation Practices Act (AOPA): Manure characteristics and land base code (1st ed.). Alberta Agriculture Food and Rural Development. Agdex 096-8. 47 pg. [Online] Available: [www1.agric.gov.ab.ca/\\$department/deptdocs.nsf/all/agdex4702/\\$FILE/096-8.pdf](http://www1.agric.gov.ab.ca/$department/deptdocs.nsf/all/agdex4702/$FILE/096-8.pdf) [1 Jan 2007].

Atia, A. 2005. Hydrogen sulphide emissions and safety. Alberta Agriculture and Food. Agdex 086-2. [Online] Available: [www1.agric.gov.ab.ca/\\$department/deptdocs.nsf/all/agdex8269?opendocument](http://www1.agric.gov.ab.ca/$department/deptdocs.nsf/all/agdex8269?opendocument) [1 Jan 2007].

BCMAL. 2005. Manure sampling and analysis for nutrient management. British Columbia Ministry of Agriculture and Lands. No. 631.500-3. [Online] Available: www.agf.gov.bc.ca/resmgmt/publist/600Series/631500-3.pdf [1 Jan 2007].

Boehme, P. 2005. Manure spreading setback distances: What is required by the Agricultural Operation Practices Act (AOPA). Alberta Agriculture and Food. [Online] Available: [http://www1.agric.gov.ab.ca/\\$department/deptdocs.nsf/all/epw9846](http://www1.agric.gov.ab.ca/$department/deptdocs.nsf/all/epw9846) [1 Jan 2007]

Boehme, P., 2004. Reference Guide Agricultural Operation Practices Act (2nd ed.). Alberta Agriculture and Food. [Online] Available: [www1.agric.gov.ab.ca/\\$department/deptdocs.nsf/all/epw8746](http://www1.agric.gov.ab.ca/$department/deptdocs.nsf/all/epw8746) [1 Jan 2007].

Brenneman, G. and Hoyer, S. 2001. Producers learn value of manure sampling and use on crop acres. [Online] Available: www.extension.iastate.edu/Pages/communications/EPC/Fall01/producers.html [1 Jan 2007].

British Columbia Ministry of Agriculture and Lands. 2005. Choosing and calibrating manure application equipment. Factsheet 6, nutrient management series. [Online] Available: <http://www.agf.gov.bc.ca/resmgmt/publist/600Series/631500-6.pdf> [1 Jan 2007]

Brodie, L.H. 1990. Determining the amount of manure in a pile or pool. Maryland Cooperative Extension. Biological Resources Engineering Facts # 176. 8 pg.

Busch, D., Wagar, T. and Schmitt, M. 2002. Livestock manure sampling. University of Minnesota Extension Service. FO-06423-GO. [Online] Available: www.extension.umn.edu/distribution/cropsystems/DC6423.html [1 Jan 2007].

Chastain, J. 2002. Chapter 7: Manure sampling procedures. South Carolina confined animal manure manager's certification program: Swine. [Online] Available: www.clemson.edu/camm/Camm_s/Ch7/sch7c_03.pdf [1 Jan 2007].

Coffey, R., Parker, G., Laurent, K. and Overhults, D. 2000. Sampling animal manure. University of Kentucky Cooperative Extension Service. ID-148. [Online] Available: www.ca.uky.edu/agc/pubs/id/id148/id148.htm [1 Jan 2007].

Dou, Z., Galligan, D.T., Allshouse, R.D., Toth, J.D., Ramberg, Jr., C.F., and Ferguson, J.D. 2001. Manure sampling for nutrient analysis: Variability and sampling efficacy. *J. Environ. Qual.* 30: 1432–1437.

Envirotest Laboratories (now ALS Environmental). 2006. ALS Environmental, agricultural services. [Online] Available: www.alsenviro.com/ag/index.html [1 Jan 2007].

- Hanna, M., Richard, T. and Norman, H. 2006. Calibration uniformity of solid manure spreaders. Iowa State University Extension. [Online] Available: <http://www.extension.iastate.edu/Publications/PM1941.pdf> [1 Jan 2007]
- Hermanson, R. 1996. Manure sampling for nutrient analysis with worksheets for calculating fertilizer values. Washington State University Cooperative Extension. EB-1819. [Online] Available: cru.cahe.wsu.edu/CEPublications/eb1819/eb1819.html [1 Jan 2007].
- Jarmen, J. 1997. Manure sampling and analysis. United States Department of Agriculture, Natural Resources Conservation Service. Fact Sheet MN-NUTR6. [Online] Available: www.mn.nrcs.usda.gov/technical/ecs/nutrient/manure/mnnutr6.pdf [1 Jan 2007].
- Johnson, D., Moffitt, D., Rickman, J. and Stettler, D. 1997. Waste management equipment. Chapter 12 in Agricultural waste management field handbook, Part 651, National engineering handbook. Natural Resources Conservation Service. [Online] Available: <http://www.info.usda.gov/CED/ftp/CED/neh651-ch12.pdf> [1 Jan 2007]
- Koelsch, R. 1995. Environmental Considerations for Manure Application System Selection. University of Nebraska, Lincoln.
- Koelsch, R. and Humenik, F. Not dated. Land application equipment. Lesson 36 in Livestock and poultry environmental stewardship curriculum. [Online] Available: http://www.lpes.org/Lessons/Lesson36/36_Application_Equipment.html [1 Jan 2007]
- Lorimor, J. and Kohl, K. 2000. Sampling and agitation of swine manure pits. [Online] Available: www.extension.iastate.edu/pages/communications/epc/Fall2000/sampling.html [1 Jan 2007].
- Marsh, L., Mullins, G., Ambler, S. and Heidel, R. 2003. Manure spreader calibration for rear-discharge equipment handling solid and semi-solid manures and poultry litter. Virginia Cooperative Extension. Publication 442-004. [Online] Available: <http://www.ext.vt.edu/pubs/bse/442-004/442-004.html> [1 Jan 2007]
- Midwest Laboratories Canada. 1999. Homepage. [Online] Available: www.midwestlabscanada.com/ [1 Jan 2007].
- Norwest Labs (now Bodycote). 2006. Homepage. [Online] Available: www.norwestlabs.com/ [1 Jan 2007].
- Olson, B. 2003. Manure nutrient management. Alberta Agriculture and Food. [Online] Available: [www1.agric.gov.ab.ca/\\$department/deptdocs.nsf/all/irr5716](http://www1.agric.gov.ab.ca/$department/deptdocs.nsf/all/irr5716) [1 Jan 2007].
- PAMI/AAFRD. 1997. A guide to pipeline manure injection systems. Prairie Agriculture Machinery Institute and Alberta Agriculture Food and Rural Development. Research update 729. [Online] Available: [http://www1.agric.gov.ab.ca/\\$department/deptdocs.nsf/all/eng9868](http://www1.agric.gov.ab.ca/$department/deptdocs.nsf/all/eng9868) [1 Jan 2007]
- PAMI/AAFRD. 1999. Low disturbance liquid manure injection: Is technology keeping up? Prairie Agriculture Machinery Institute and Alberta Agriculture Food and Rural Development. Research update 744. [Online] Available: [http://www1.agric.gov.ab.ca/\\$department/deptdocs.nsf/all/eng9839](http://www1.agric.gov.ab.ca/$department/deptdocs.nsf/all/eng9839) [1 Jan 2007]
- Peters, J. and Combs, S. 2003. Sampling livestock waste for analysis. Pages 1-4. in J. Peters, ed. Recommended methods of manure analysis. University of Wisconsin Extension. A-3769. [Online] Available: <http://learningstore.uwex.edu/pdf/A3769.pdf> [1 Jan 2007].

- Sexton, B., B. Metzger and V. Nelson. 2005. Performance evaluation of five liquid manure injection technologies. Alberta Agriculture and Food. [Online] Available: [www1.agric.gov.ab.ca/\\$department/deptdocs.nsf/all/agdex10096/\\$FILE/743-1_report.pdf](http://www1.agric.gov.ab.ca/$department/deptdocs.nsf/all/agdex10096/$FILE/743-1_report.pdf) [1 Jan 2007]
- Shaffer, K. and Sheffield, R. Not Dated. Lesson 35: Land application records and sampling. Livestock and poultry environmental stewardship curriculum. [Online] Available: www.lpes.org/Lessons/Lesson35/35_2_Manure_Sampling.pdf [1 Jan 2007].
- Smolen, M., Zhang, H. and Hamilton, D. 2002. Standard operating procedures: Estimating volume and bulk density of poultry litter in the house. Oklahoma Cooperative Extension Service. Production Technology 2002-28. 2 pg.
- Stettler, D. Moffitt, D. and Rickman, J. 1996. Calibrating manure spreaders. Appendix 13A in Agricultural waste management field handbook, Part 651, National engineering handbook. Natural Resources Conservation Service. [Online] Available: <http://www.info.usda.gov/CED/ftp/CED/neh651-ch13.pdf> [1 Jan 2007]
- Stewart, K. 2005. Liquid manure injection technologies: Performance evaluation. Alberta Agriculture and Food. Agdex 743-1. [Online] Available: [http://www1.agric.gov.ab.ca/\\$department/deptdocs.nsf/all/agdex10096](http://www1.agric.gov.ab.ca/$department/deptdocs.nsf/all/agdex10096) [1 Jan 2007]
- United States Department of Agriculture. 2006. Natural Resources Conservation Service, Photo gallery. [Online] Available: <http://photogallery.nrcs.usda.gov/> [1 Jan 2007]
- Wallace, T. 2004. Tri-Provincial manure application and use guidelines: Alberta version. Prairie Provinces' Committee on Livestock Development and Manure Management. [Online] Available: [www1.agric.gov.ab.ca/\\$department/deptdocs.nsf/all/epw8709](http://www1.agric.gov.ab.ca/$department/deptdocs.nsf/all/epw8709) [1 Jan 2007].
- Wallace, T. 2004. Tri-Provincial manure application and use guidelines: Alberta version. Prairie Provinces' Committee on Livestock Development and Manure Management. [Online] Available: [www1.agric.gov.ab.ca/\\$department/deptdocs.nsf/all/epw8709](http://www1.agric.gov.ab.ca/$department/deptdocs.nsf/all/epw8709) [1 Jan 2007].
- Zhang, H., Hamilton, D. and Britton, J. Not Dated. Sampling Animal Manure. Oklahoma Cooperative Extension Service. F-2248. [Online] Available: www.soiltesting.okstate.edu/Extn_Pub/F-2248web.pdf [1 Jan 2007].
- Brady, N.C. and Weil, R.R. 2000. The nature and properties of soils (13th ed.). Prentice Hall, Upper Saddle River, NJ. 960 pg.
- Hall, M. and Solberg, E. 2001. Sulphur fertilizer application in crop production. Alberta Agriculture, Food & Rural Development. Agdex 542-10. [Online] Available: [http://www1.agric.gov.ab.ca/\\$department/deptdocs.nsf/all/agdex3526?opendocument](http://www1.agric.gov.ab.ca/$department/deptdocs.nsf/all/agdex3526?opendocument) [1 Jan 2007]
- Havlin, J.L., Beaton, J.D., Tisdale, S.L. and Nelson, W.L. 2005. Soil fertility and fertilizers: An introduction to nutrient management (7th ed.). Prentice Hall, Upper Saddle River, NJ. 515 pg.
- Jones, C. and Jacobsen, J. 2003a. Fertilizer placement and timing. Nutrient management module 11. Montana State University Extension Service. Publication 4449-11. [Online] Available: <http://landresources.montana.edu/NM/Modules/NM11layout.pdf> [1 Jan 2007]
- Karamanos, R. 2006. Micronutrients for irrigated production. Proceedings, Irrigated Crop Production Update Conference. January 17th, 2006. Alberta Agriculture and Food. [Online] Available: [http://www1.agric.gov.ab.ca/\\$department/deptdocs.nsf/all/ind10751](http://www1.agric.gov.ab.ca/$department/deptdocs.nsf/all/ind10751) [1 Jan 2007]

Module 5.0

Korol, M. 2004. Fertilizer and pesticide management in Canada. Statistics Canada. Catalogue no. 21-021-MIE. [Online] Available: <http://www.statcan.ca/english/research/21-021-MIE/2004002/pdf/21-021-MIE2004002.pdf> [1 Jan 2007]

McCauley, A., Jones, C. and Jacobsen, J. 2003. Commercial fertilizers and soil amendments. Nutrient management module 10. Montana State University Extension Service. Publication 4449-10. [Online] Available: <http://landresources.montana.edu/NM/Modules/NM10layout.pdf> [1 Jan 2007]

McKenzie, R. 1992. Micronutrient requirements of crops. Alberta Agriculture and Food. Agdex 531-1. [Online] Available: [http://www1.agric.gov.ab.ca/\\$department/deptdocs.nsf/all/agdex713?opendocument](http://www1.agric.gov.ab.ca/$department/deptdocs.nsf/all/agdex713?opendocument) [1 Jan 2007]

McKenzie, R. 1998. Crop nutrition and fertilizer requirements. Alberta Agriculture and Food. Agdex 540-1. [Online] Available: [http://www1.agric.gov.ab.ca/\\$department/deptdocs.nsf/all/agdex3791?opendocument](http://www1.agric.gov.ab.ca/$department/deptdocs.nsf/all/agdex3791?opendocument) [1 Jan 2007]

McKenzie, R. 2000. Potassium fertilizer application in crop production. Alberta Agriculture and Food. Agdex 542-9. [Online] Available: [http://www1.agric.gov.ab.ca/\\$department/deptdocs.nsf/all/agdex917?opendocument](http://www1.agric.gov.ab.ca/$department/deptdocs.nsf/all/agdex917?opendocument) [1 Jan 2007]

McKenzie, R. and Kryzanowski, L. 2003. Fertilizing irrigated grain and oilseed crops. Alberta Agriculture and Food. Agdex 100/541-1. [Online] Available: [http://www1.agric.gov.ab.ca/\\$department/deptdocs.nsf/all/agdex149?opendocument](http://www1.agric.gov.ab.ca/$department/deptdocs.nsf/all/agdex149?opendocument) [1 Jan 2007]

McKenzie, R. and Middleton, A. 1997. Phosphorus fertilizer application in crop production. Alberta Agriculture and Food. Agdex 542-3. [Online] Available: [http://www1.agric.gov.ab.ca/\\$department/deptdocs.nsf/all/agdex920?opendocument](http://www1.agric.gov.ab.ca/$department/deptdocs.nsf/all/agdex920?opendocument) [1 Jan 2007]

Module 6.0

Olson, B. 2003. Manure nutrient management. Alberta Agriculture and Food. [Online] Available: [www1.agric.gov.ab.ca/\\$department/deptdocs.nsf/all/irr5716](http://www1.agric.gov.ab.ca/$department/deptdocs.nsf/all/irr5716) [1 Jan 2007].

Wallace, T. 2004. Tri-Provincial manure application and use guidelines: Alberta version. Prairie Provinces' Committee on Livestock Development and Manure Management. [Online] Available: [www1.agric.gov.ab.ca/\\$department/deptdocs.nsf/all/epw8709](http://www1.agric.gov.ab.ca/$department/deptdocs.nsf/all/epw8709) [1 Jan 2007].

AAFRD. 2006. Agricultural Operation Practices Act (AOPA): Manure characteristics and land base code (1st ed.). Alberta Agriculture Food and Rural Development. Agdex 096-8. 47 pg. [Online] Available: [www1.agric.gov.ab.ca/\\$department/deptdocs.nsf/all/agdex4702/\\$FILE/096-8.pdf](http://www1.agric.gov.ab.ca/$department/deptdocs.nsf/all/agdex4702/$FILE/096-8.pdf) [1 Jan 2007].

Module 7.0

Alberta Agriculture and Food. 2006. Alberta Farm Fertilizer Information and Recommendation Manager (AFFIRM). [Online] Available: [www1.agric.gov.ab.ca/\\$department/deptdocs.nsf/all/crop10159](http://www1.agric.gov.ab.ca/$department/deptdocs.nsf/all/crop10159) [1 Jan 2007]

Alberta Agriculture and Food. 2006. Alberta Manure Management Planner - 2005. [Online] Available: [www1.agric.gov.ab.ca/\\$department/deptdocs.nsf/all/epw8834](http://www1.agric.gov.ab.ca/$department/deptdocs.nsf/all/epw8834) [1 Jan 2007]

Alberta Agriculture and Food. 2005. Manure management record keeping: What is required by the Agricultural Operation Practices Act. Agdex FS096-3 [Online] Available: [www1.agric.gov.ab.ca/\\$department/deptdocs.nsf/all/epw9082](http://www1.agric.gov.ab.ca/$department/deptdocs.nsf/all/epw9082) [1 Jan 2007]

Alberta Agriculture and Food. 2006. Manure or Compost Transfer Record Form. [Online] Available: [www1.agric.gov.ab.ca/\\$department/deptdocs.nsf/all/epw9082/\\$FILE/manure_compost_transfer_record.pdf](http://www1.agric.gov.ab.ca/$department/deptdocs.nsf/all/epw9082/$FILE/manure_compost_transfer_record.pdf) [1 Jan 2007]

Alberta Agriculture and Food. 2006. CFO Manure or Compost Production Record Form. [Online] Available: [www1.agric.gov.ab.ca/\\$department/deptdocs.nsf/all/epw9082/\\$FILE/cfo_manure_compost_production_record.pdf](http://www1.agric.gov.ab.ca/$department/deptdocs.nsf/all/epw9082/$FILE/cfo_manure_compost_production_record.pdf) [1 Jan 2007]

Alberta Agriculture and Food. 2006. Land Application Record Form. [Online] Available: [www1.agric.gov.ab.ca/\\$department/deptdocs.nsf/all/epw9082/\\$FILE/land_application_record.pdf](http://www1.agric.gov.ab.ca/$department/deptdocs.nsf/all/epw9082/$FILE/land_application_record.pdf) [1 Jan 2007]

Alberta Agriculture and Food. 2006. Agricultural Operation Practices Act (AOPA): Manure characteristics and land base code (1st ed.). Agdex 096-8. 47 pg. [Online] Available: [www1.agric.gov.ab.ca/\\$department/deptdocs.nsf/all/agdex4702/\\$FILE/096-8.pdf](http://www1.agric.gov.ab.ca/$department/deptdocs.nsf/all/agdex4702/$FILE/096-8.pdf) [1 Jan 2007]

Module 8.0

Aasen, A. and Baron, V. 2001. Winter cereals for pasture. Alberta Agriculture and Food. Agdex 133/20-1. [Online] Available: [www1.agric.gov.ab.ca/\\$department/deptdocs.nsf/all/agdex145?opendocument](http://www1.agric.gov.ab.ca/$department/deptdocs.nsf/all/agdex145?opendocument) [1 Jan 2007]

Alberta Environmental Farm Plan Company. 2006. Homepage. [Online] Available: www.albertaefp.com [1 Jan 2007]

Alberta Forage Variety Committee. 2006. Varieties of perennial hay and pasture crops for Alberta. Alberta Agriculture and Food. Agdex 120/32. [Online] Available: [www1.agric.gov.ab.ca/\\$department/deptdocs.nsf/all/agdex105?opendocument](http://www1.agric.gov.ab.ca/$department/deptdocs.nsf/all/agdex105?opendocument) [1 Jan 2007]

Association of Professional Engineers, Geologists and Geophysicists of Alberta. 2006. Homepage. [Online] Available: www.apegga.org [1 Jan 2007]

Atia, A. 2006. Applying manure on perennial forage. Alberta Agriculture and Food. Agdex 538/120-2. [Online] Available: [www1.agric.gov.ab.ca/\\$department/deptdocs.nsf/all/agdex10727](http://www1.agric.gov.ab.ca/$department/deptdocs.nsf/all/agdex10727) [1 Jan 2007]

Brady, N.C. and Weil, R.R. 2000. The nature and properties of soils (13th ed.). Prentice Hall, Upper Saddle River, NJ. 960 pg.

Brandt, S. 2006. Tillage practices that reduce soil erosion. [Online] Available: www.agr.gc.ca/pfra/soil/tillage_e.htm [1 Jan 2007]

Carman, D. (not dated). Strip cropping. SERA-17, Phosphorus best management practices factsheet series. [Online] Available: www.sera17.ext.vt.edu/Documents/BMP_strip_cropping.pdf [1 Jan 2007]

Chrapko, D. 1993. Summer fallow and soil conservation. Alberta Agriculture and Food. Agdex 570-3. [Online] Available: [www1.agric.gov.ab.ca/\\$department/deptdocs.nsf/all/agdex980?opendocument](http://www1.agric.gov.ab.ca/$department/deptdocs.nsf/all/agdex980?opendocument) [1 Jan 2007]

Connecticut River Joint Commission. 1998. Buffers for agriculture. [Online] Available: <http://www.crjc.org/buffers/Buffers%20for%20Agriculture.pdf> [1 Jan 2007]

Connecticut River Joint Commission. 1998. Introduction to riparian buffers. [Online] Available: <http://www.crjc.org/buffers/Introduction.pdf> [1 Jan 2007]

Conservation Technology Information Centre. 2006. Contour strip cropping. [Online] Available: <http://lanshark.ctic.purdue.edu/Core4/CT/Choices/Choice13.html> [1 Jan 2007]

- DeBusk, W.F. 1999. Nitrogen cycling in wetlands. Florida Cooperative Extension Service. Factsheet SL171. [Online] Available: <http://edis.ifas.ufl.edu/pdffiles/SS/SS30300.pdf> [1 Jan 2007]
- DeBusk, W.F. 1999. Phosphorus cycling in wetlands. Florida Cooperative Extension Service. Factsheet SL170. [Online] Available: <http://edis.ifas.ufl.edu/pdffiles/SS/SS30200.pdf> [1 Jan 2007]
- DeBusk, W.F. 1999. Wastewater treatment wetlands: Contaminant removal processes. Florida Cooperative Extension Service. Factsheet SL 155. [Online] Available: <http://edis.ifas.ufl.edu/pdffiles/SS/SS29300.pdf> [1 Jan 2007]
- Dunn, R. 2006. Making the move to direct seeding. Alberta Agriculture and Food. Agdex 570-5. [Online] Available: [www1.agric.gov.ab.ca/\\$department/deptdocs.nsf/all/agdex790?opendocument](http://www1.agric.gov.ab.ca/$department/deptdocs.nsf/all/agdex790?opendocument) [1 Jan 2007]
- Dunn, R. and Fleury, D. 1998. Direct seeded winter wheat. Alberta Agriculture and Food. Agdex 112/22-1. [Online] Available: [www1.agric.gov.ab.ca/\\$department/deptdocs.nsf/all/agdex106?opendocument](http://www1.agric.gov.ab.ca/$department/deptdocs.nsf/all/agdex106?opendocument) [1 Jan 2007]
- Environmental Protection Agency. Not dated. A handbook of constructed wetlands, Volume 1: General considerations. [Online] Available: <http://www.epa.gov/owow/wetlands/pdf/hand.pdf> [1 Jan 2007]
- Fowler, D. 2002. Winter cereal production manual. [Online] Available: http://www.usask.ca/agriculture/plantsci/winter_cereals/index.php [1 Jan 2007]
- Froebel, B. and Howard, A. 1999. Soil temperature and direct seeding. Alberta Agriculture and Food. Agdex 590-2. [Online] Available: [www1.agric.gov.ab.ca/\\$department/deptdocs.nsf/all/agdex1164?opendocument](http://www1.agric.gov.ab.ca/$department/deptdocs.nsf/all/agdex1164?opendocument) [1 Jan 2007]
- Goddard, T. 1993. Legume green manuring. Alberta Agriculture and Food. Agdex 123/20-2. [Online] Available: [www1.agric.gov.ab.ca/\\$department/deptdocs.nsf/all/agdex133](http://www1.agric.gov.ab.ca/$department/deptdocs.nsf/all/agdex133) [1 Jan 2007]
- Green, M. 1999. Direct seeding systems: terms, definitions and explanations. Alberta Agriculture and Food. Agdex 570-7. [Online] Available: [www1.agric.gov.ab.ca/\\$department/deptdocs.nsf/all/agdex3483?opendocument](http://www1.agric.gov.ab.ca/$department/deptdocs.nsf/all/agdex3483?opendocument) [1 Jan 2007]
- Green, M. 1999. Handling difficult crop residue conditions in direct seeding systems. Alberta Agriculture and Food. Agdex 519-2. [Online] Available: [www1.agric.gov.ab.ca/\\$department/deptdocs.nsf/all/agdex174?opendocument](http://www1.agric.gov.ab.ca/$department/deptdocs.nsf/all/agdex174?opendocument) [1 Jan 2007]
- Green, M. 1999. Residue management for successful direct seeding. Alberta Agriculture and Food. Agdex 570-4. [Online] Available: [www1.agric.gov.ab.ca/\\$department/deptdocs.nsf/all/agdex1205?opendocument](http://www1.agric.gov.ab.ca/$department/deptdocs.nsf/all/agdex1205?opendocument) [1 Jan 2007]
- Hartman, M. 1999. Estimating the value of crop residues. Alberta Agriculture and Food. Agdex 519-25. [Online] Available: [www1.agric.gov.ab.ca/\\$department/deptdocs.nsf/all/agdex2512?opendocument](http://www1.agric.gov.ab.ca/$department/deptdocs.nsf/all/agdex2512?opendocument) [1 Jan 2007]
- Hirschi, M., Frazee, R., Czapar, G. and Peterson, D. 1997. Sixty ways farmers can protect water quality. North Central Regional Extension Publication 589. University of Illinois, Urbana-Champaign. 317 pg.
- Hutton, G., Berg, B., Najda, H., Johns, M., Cole, D. and Yoder, C. 2005. Perennial forage establishment in Alberta. Alberta Agriculture and Food. Agdex 120/22-3. [Online] Available: [www1.agric.gov.ab.ca/\\$department/deptdocs.nsf/all/agdex9682](http://www1.agric.gov.ab.ca/$department/deptdocs.nsf/all/agdex9682) [1 Jan 2007]

- Lim, T.T., Edwards, D.R., Workman, S.R., Larson, B.T. and Dunn, L. 1998. Vegetated filter strip removal of cattle manure constituents in runoff. *Transac. ASAE* 41(5): 1375-1381
- McGill University. Not Dated. The basics of green manuring. EAP Publication 51. [Online] Available: <http://eap.mcgill.ca/Publications/EAP51.htm> [1 Jan 2007]
- Miller, R.W. and Donohue, R.L. 1990. Soils: An introduction to soils and plant growth. Prentice Hall, Upper Saddle River, NJ. 768 pg.
- National Sustainable Agriculture Information Service. 2003. Overview of cover crops and green manures. [Online] Available: <http://attra.ncat.org/attra-pub/covercrop.html> [1 Jan 2007]
- Natural Resources Conservation Service. 1984. Terraces. Chapter 8 in National Engineering Field Handbook. [Online] Available: <http://www.info.usda.gov/CED/ftp/CED/EFH-Ch08.pdf> [1 Jan 2007]
- Natural Resources Conservation Service. 1986. Grassed Waterways, Chapter 7 in National Engineering Field Handbook. [Online] Available: www.info.usda.gov/CED/ftp/CED/EFH-Ch07.pdf [1 Jan 2007]
- Natural Resources Conservation Service. 2000. Constructed wetland. National Conservation Practice Standard 656 in Electronic Field Office Technical Guide. [Online] Available: <ftp://ftp-fc.sc.egov.usda.gov/NHQ/practice-standards/standards/656.pdf> [1 Jan 2007]
- Natural Resources Conservation Service. 2000. Contour farming. National conservation practice standard 330 in Electronic field office technical guide. [Online] Available: <ftp://ftp-fc.sc.egov.usda.gov/NHQ/practice-standards/standards/330.pdf> [1 Jan 2007]
- Natural Resources Conservation Service. 2000. Grassed waterway (National Conservation Practice Standard 412). Electronic Field Office Technical Guide. [Online] Available: <ftp://ftp-fc.sc.egov.usda.gov/NHQ/practice-standards/standards/412.pdf> [1 Jan 2007]
- Natural Resources Conservation Service. 2002. Constructed wetlands. Chapter 3 in Environmental Engineering Handbook, Part 637 National Engineering Handbook. [Online] Available: <ftp://ftp.wcc.nrcs.usda.gov/downloads/wastemgmt/NEH637Ch3ConstructedWetlands.pdf> [1 Jan 2007]
- Natural Resources Conservation Service. 2002. Snowmelt. Chapter 11 in Hydrology, Part 630 National Engineering Handbook. [Online] Available: http://policy.nrcs.usda.gov/media/pdf/H_210_630_11.pdf [1 Jan 2007]
- Natural Resources Conservation Service. 2002. Stripcropping. National Conservation Practice Standard 585 in Electronic Field Office Technical Guide. [Online] Available: <ftp://ftp-fc.sc.egov.usda.gov/NHQ/practice-standards/standards/585.pdf> [1 Jan 2007]
- Natural Resources Conservation Service. 2002. Terrace. National Conservation Practice Standard 600 in Electronic Field Office Technical Guide. [Online] Available: <ftp://ftp-fc.sc.egov.usda.gov/NHQ/practice-standards/standards/412.pdf> [1 Jan 2007]
- Natural Resources Conservation Service. 2003. Filter strips. National Conservation Practice Standard 393 in Electronic Field Office Technical Guide. [Online] Available: <ftp://ftp-fc.sc.egov.usda.gov/NHQ/practice-standards/standards/393.pdf> [1 Jan 2007]

- Ontario Ministry of Agriculture, Food and Rural Affairs. 2006. Vegetated Filter Strip Design Manual. Publication 826. [Online] Available: www.omafra.gov.on.ca/english/engineer/facts/vfss_manual/vfsmantc.htm [1 Jan 2007]
- PFRA. 2006. Economics of zero till. [Online] Available: www.agr.gc.ca/pfra/soil/swork1.htm [1 Jan 2007]
- Salmon, D. and McClelland, M. 1999. Winter wheat in the Parkland area of Alberta. Alberta Agriculture and Food. Agdex 112/11-1. [Online] Available: [www1.agric.gov.ab.ca/\\$department/deptdocs.nsf/all/agdex94?opendocument](http://www1.agric.gov.ab.ca/$department/deptdocs.nsf/all/agdex94?opendocument) [1 Jan 2007]
- United States Department of Agriculture. 2006. Agricultural Research Service, National Soil Erosion Research Lab. [Online] Available: http://www.ars.usda.gov/main/site_main.htm?modecode=36021500 [1 Jan 2007]
- Vanderwel, D.S. and Jedrych, A.T. 2005. A method for developing best management practices to prevent water erosion on farmland using WEPP. CAESA Soil Quality CSQ Research Factsheet 11. Alberta Agriculture and Food. [Online] Available: [http://www1.agric.gov.ab.ca/\\$department/deptdocs.nsf/all/sag5804](http://www1.agric.gov.ab.ca/$department/deptdocs.nsf/all/sag5804) [1 Jan 2007]
- Wall, G.E., Coote, D.R., Pringle, E.A. and Shelton, I.J. (Eds). 1997. Revised universal soil loss equation for application in Canada: A handbook for estimating soil loss from water erosion in Canada. [Online] Available: http://res2.agr.ca/CRECO/pubs/pdf/rusle_e.pdf [1 Jan 2007]
- Yoder, H. 1999. Removing forages from the rotation in a direct seeding system. Alberta Agriculture and Food. Agdex 519-17. [Online] Available: [www1.agric.gov.ab.ca/\\$department/deptdocs.nsf/all/agdex1254?opendocument](http://www1.agric.gov.ab.ca/$department/deptdocs.nsf/all/agdex1254?opendocument) [1 Jan 2007]
- Zylstra, J. 1996. Soil quality and moisture conservation benefits of direct seeding. Alberta Agriculture and Food. Agdex 570-6. [Online] Available: [www1.agric.gov.ab.ca/\\$department/deptdocs.nsf/all/agdex1163?opendocument](http://www1.agric.gov.ab.ca/$department/deptdocs.nsf/all/agdex1163?opendocument) [1 Jan 2007]

